

Final Research Report
Research Project T9903, Task 9
ATIS/ATMS Regional IVHS Demonstration

**ITS DATA
FUSION**

by

Daniel J. Dailey, Patricia Harn, Po-Jung Lin
ITS Research Program
College of Engineering, Box 352500
University of Washington
Seattle, Washington 98195-2500

Washington State Transportation Center (TRAC)
University of Washington, Box 354802
University District Building
1107 NE 45th Street, Suite 535
Seattle, Washington 98105-4631

Washington State Department of Transportation
Technical Monitor
Pete Briglia
Advanced Technology Branch Manager

Prepared for

Washington State Transportation Commission
Department of Transportation
and in cooperation with
U.S. Department of Transportation
Federal Highway Administration

September 1996

TECHNICAL REPORT STANDARD TITLE PAGE

1. REPORT NO. WA-RD 410.1	2. GOVERNMENT ACCESSION NO.	3. RECIPIENT'S CATALOG NO.	
4. TITLE AND SUBTITLE ITS DATA FUSION		5. REPORT DATE September 1996	
		6. PERFORMING ORGANIZATION CODE	
7. AUTHOR(S) Daniel J. Dailey, Patricia Harn, Po-Jung Lin		8. PERFORMING ORGANIZATION REPORT NO.	
9. PERFORMING ORGANIZATION NAME AND ADDRESS Washington State Transportation Center (TRAC) University of Washington, Box 354802 University District Building; 1107 NE 45th Street, Suite 535 Seattle, Washington 98105-4631		10. WORK UNIT NO.	
		11. CONTRACT OR GRANT NO. T9903, Task 9	
12. SPONSORING AGENCY NAME AND ADDRESS Washington State Department of Transportation Transportation Building, MS 7370 Olympia, Washington 98504-7370		13. TYPE OF REPORT AND PERIOD COVERED Final research report	
		14. SPONSORING AGENCY CODE	
15. SUPPLEMENTARY NOTES This study was conducted in cooperation with the U.S. Department of Transportation, Federal Highway Administration.			
16. ABSTRACT <p>This project has accomplished three significant tasks. First, a state-of-the-art literature review has provided an organizational framework for categorizing the various data fusion projects that have been conducted to date. A popular typology was discussed which situates data fusion technologies in one of three levels, depending on the degree to which sensor data is correlated to provide users with meaningful transit recommendations. The trade-offs that accompany higher-level data fusion efforts — in terms of computing power and memory requirements — were noted. The advantages of multiple-sensor data fusion projects in terms of cost, accuracy, and reliability were also discussed and contrasts were drawn with the traditional deployment of highly accurate, single sensors. Specific techniques of data fusion were described and their possible applications to ITS projects were explored. In fact, this report is one of the first to consider how data fusion technology might be productively applied to the needs of transportation management. A second major component of this report is the description provided of a local data fusion application. This project employs data fusion techniques to correlate input from multiple highway sensors and generate reliable traffic predictions. The resulting information can be displayed for use by commuters as they choose from among various transit options. The architecture of this data fusion system is described in detail. The third component of the project was to create a statistically based algorithm to estimate speed from volume and occupancy measurements. The algorithm presented explicitly accounts for the statistics of the problem and provides a robustness test for the speed estimate.</p>			
17. KEY WORDS traveler information, ITS backbone, distributed computing, client server model, ITS architecture, speed estimates, volume, occupancy		18. DISTRIBUTION STATEMENT No restrictions. This document is available to the public through the National Technical Information Service, Springfield, VA 22616	
19. SECURITY CLASSIF. (of this report) None	20. SECURITY CLASSIF. (of this page) None	21. NO. OF PAGES 100	22. PRICE

DISCLAIMER

The contents of this report reflect the views of the authors, who are responsible for the facts and the accuracy of the data presented herein. The contents do not necessarily reflect the official views or policies of the Washington State Transportation Commission, Department of Transportation, or the Federal Highway Administration. This report does not constitute a standard, specification, or regulation.

CONTENTS

Executive Summary	v
1 INTRODUCTION	1
2 BACKGROUND AND STATE-OF-THE-ART REVIEW	3
2.1 LEVEL ONE FUSION	6
2.1.1 Data Association	6
2.1.2 Positional Estimation: Kalman Filters	7
2.1.3 Kalman Filters Applications	9
2.2 LEVEL TWO FUSION	10
2.2.1 Bayesian Decision Theory	10
2.2.2 Bayesian Decision Theory Applications	13
2.2.3 Dempster-Shafer Evidential Reasoning	14
2.2.4 DSER Applications	15
2.2.5 Neural Networks	16
2.2.6 Neural Networks Applications	18
2.3 LEVEL THREE FUSION	19
2.3.1 Expert Systems	19
2.3.2 Expert Systems Applications	21
2.3.3 Blackboard Architecture	23
2.3.4 Blackboard Architecture Applications	24
2.3.5 Fuzzy Logic	25
2.3.6 Fuzzy Logic Applications	26
2.4 STATE-OF-THE-ART SUMMARY	27

3	DATA FUSION: LOOP DATA FLOWS	31
3.1	TMSUW ON HARLEY	33
3.2	LOOP REBROADCAST SERVER	36
3.3	LOOP REPEATER SERVER	38
3.4	LOOP SERVER	39
4	DATA FUSION: LOOP SPEED ESTIMATES	41
4.1	DETERMINISTIC MEASUREMENTS	44
4.2	STOCHASTIC MEASUREMENTS	44
4.3	EMPIRICAL RESULTS	47
4.4	SPEED ESTIMATES CONCLUSIONS AND RECOMMENDATIONS	49
5	CONCLUSIONS	55
6	REFERENCES	57
A	GLOSSARY WITH ACRONYMS	67
B	ANNOTATED BIBLIOGRAPHY OF SELECTED DATA FUSION REVIEWS	73
C	SUPPLEMENTAL ANNOTATED BIBLIOGRAPHY	75

LIST OF FIGURES

2.1	Frequency distribution of the general methods used in U.S. military data fusion projects (Linn and Hall, 1991).	6
2.2	Calculations involved in a Kalman filter (Bahowick, 1990).	8
2.3	Centralized versus decentralized architecture (Belcastro et al., 1991)	11
2.4	Decision support and classification model (Fennelly et al., 1992). . .	12
2.5	Increased confidence level made possible by soft-decision sensors (Buede & Waltz, 1989).	13
2.6	Architecture of the original genre of neural network systems (DeClaris, 1992).	17
2.7	Architecture of ADVANCE (Kirson et al., 1992).	21
2.8	Expert system logic in an IGHLC system (Niehaus & Stengel, 1991).	23
2.9	Sample blackboard architecture (Leung & Williams, 1991).	25
2.10	Fuzzy logic involved with classifying rainfall (Gupta, 1992).	26
3.1	Architecture of the TSMC traffic reporting system.	32
3.2	TSMC global memory databases.	33
3.3	RTDB memory data block allocation.	35
3.4	Flow chart of the TMSUW process.	36
3.5	LOOP REBROADCAST server components.	37
3.6	Architecture of the LOOP REPEATER server.	38
3.7	System architecture.	40
4.1	Histogram of effective vehicle length.	48
4.2	Speed estimates at free flow.	51
4.3	Speed estimates for low speeds.	52
4.4	Effective vehicle length estimates as a function of time.	53

4.5 Effective vehicle length as measured by the TMS. 53

Executive Summary

The ATIS/ATMS Regional ITS Demonstration project report consists of three main parts: (1) an extensive, state-of-the-art literature review of data fusion technologies, (2) a detailed description of a current data amalgamation (fusion) project based at the University of Washington, and (3) the presentation of a new quantitative data fusion algorithm to estimate speed from volume and occupancy measurements. Data fusion technologies are categorized according to the level of detailed inference and user recommendations they provide from various data inputs. Five general methods of data fusion are discussed, with examples of specific fusion techniques; applications for those techniques are cited, and special attention is given to their implementation in ITS projects. In addition to a broad literature review, we describe two local data fusion projects that use highway sensor data to (1) aggregate loop data for reuse by traveler information systems and (2) generate reliable traffic speed estimates that can be used by regional commuters to guide their transit decisions.

The architecture of the data fusion system based at the University of Washington consists of four major components. These components are partitioned among various computers that are located at different sites and connected by a local area network and T1 lines. Within these computers exist dedicated servers that handle specific processes. The TMSUW server collects loop data from the RTDB main memory and then broadcasts them over a local area network. The loop rebroadcast server collects the broadcast data and retransmits them over a T1 line. The loop repeater server, located at the University of Washington, receives each data packet sent over the T1 link. This arrangement reduces the load on the loop rebroadcast server and provides for future expansion. The loop server, the final component of the system, provides highway data for end users. This data includes occupancy and volume information for each loop and station, as well as details on the average speed and length for each speed trap.

This project has accomplished three significant tasks. First, a state-of-the-art literature review has provided an organizational framework for categorizing the various data fusion projects that have been conducted to date. A popular typology was discussed that situates data fusion technologies in one of three levels, depending on the degree to which sensor data are correlated to provide users with meaningful transit recommendations. The trade-offs that accompany higher-level data fusion efforts – in terms of computing power and memory requirements – were noted. The advantages of multiple-sensor data fusion projects in terms of cost, accuracy and reliability were also discussed, and contrasts were drawn with the traditional deployment of highly accurate, single sensors. Specific techniques of data fusion were described and their possible application to ITS projects was explored. In fact, this report is one of the first to consider how data fusion technology might be productively applied to the needs of transportation management. A second major component of this report is the description of a local data fusion application. This project employs data fusion techniques to correlate input from multiple highway sensors and generate reliable traffic predictions. The resulting information can be displayed for use by commuters as they choose from among various transit options. The architecture of this data fusion system is described in detail. The third component of the project was to create a statistically based algorithm to estimate speed from volume and occupancy measurements. The algorithm presented explicitly accounts for the statistics of the problem and provides a robustness test for the speed estimate.

1. INTRODUCTION

This report on the ATIS/ATMS Regional ITS Demonstration project consists of three main parts: (1) an extensive state-of-the-art literature review of data fusion technologies, (2) a detailed description of a current data amalgamation (fusion) project based at the University of Washington, and (3) the presentation of a new quantitative data fusion algorithm to estimate speed from volume and occupancy measurements. Data fusion technologies are categorized according to the level of detailed inference and user recommendations they provide from various data inputs. Five general methods of data fusion are discussed and examples are given of specific fusion techniques. In addition, applications for those techniques are cited, and special attention is given to their implementation in ITS projects. We also describe two local data fusion projects that (1) aggregate loop data for reuse by traveler information systems and (2) generate reliable traffic speed estimates that regional commuters can use to guide their transit decisions.

2. BACKGROUND AND STATE-OF-THE-ART REVIEW

As its name implies, multi-sensor data fusion is a technique by which data from several sensors are combined through a centralized data processor to provide comprehensive and accurate information. Although the provision of a single data stream from multiple inputs is advantageous, the powerful potential of this technology stems from its ability to track changing conditions and anticipate impacts more consistently than could traditionally be done with a single data source – even a highly reliable one. Thus, multi-sensor data fusion makes it possible to create a synergistic process in which the consolidation of individual data creates a combined resource with a productive value greater than the sum of its parts (Hackett & Shah, 1990).

Data fusion technology is still in its infancy, having undergone rapid growth that started in the late 1980s and has continued to the present. The U.S. Department of Defense conducted much of the early research on this technology and explored its usefulness in military surveillance and land-based battle management systems. The application of data fusion technology to commercial endeavors (e.g., robotics and general image processing) and non-military government projects (e.g., weather surveillance and NASA missions) is also growing rapidly. In its current state, the technology can combine sensor data of many types, including radar, infrared, sonar, and visual information. Data fusion has been given much attention in the engineering literature, yet relatively few articles discuss its potential usefulness for transportation management or Intelligent Transportation Systems (ITS). ITS refers to modern transportation systems that integrate advanced surveillance, communications, computer, and other technologies for purposes of improving the efficiency and safety of highways (Shuman, 1993).

Current multi-sensor data fusion projects are testing the ability of the technology

to deliver information that provides the following (Sarma & Raju, 1991; Lin et al., 1991):

- Increased confidence: more than one sensor can confirm the same target
- Reduced ambiguity: joint information from multiple sensors reduces the set of hypotheses about the target
- Improved detection: integration of multiple measurements of the same target improves signal-to-noise ratio, which increases the assurance of detection
- Increased robustness: one sensor can contribute information where others are unavailable, inoperative, or ineffective
- Enhanced spatial and temporal coverage: one sensor can work when or where another sensor cannot
- Decreased costs: a suite of “average” sensors can achieve the same level of performance as a single, highly-reliable sensor and at a significantly lower cost.

Several data fusion algorithms have been developed and applied, individually and in combination, providing users with various levels of informational detail. In reviewing this emerging technology, the U.S. Defense Department’s Joint Directorate of Laboratories Data Fusion Subpanel has developed three basic categories – or levels – of data fusion (Linn & Hall, 1991). These fusion levels are differentiated according to the amount of information they provide. The most basic level involves the fusion of multi-sensor data to determine the position, velocity, and identity of a target. At this level, however, only raw, uncorrelated data are provided to the user. In comparison, level two data fusion provides a higher level of inference and delivers additional interpretive meaning suggested from the raw data. Level three data fusion is designed to make assessments and provide recommendations to the user, much as occurs in knowledge-based expert systems (KBES). Thus, each jump between data fusion levels represents a corresponding leap in technological complexity to produce increasingly valuable informational detail.

According to Linn and Hall's 1991 taxonomy of data fusion algorithms, five general, goal-oriented, data fusion methods are in use today: data association, positional estimation, identity fusion, pattern recognition, and artificial intelligence (Linn & Hall, 1991). Within these five general categories, ten discrete data fusion techniques can be identified (see Table 2.1).

Table 2.1: Common data fusion techniques

Fusion Level	General Method	Specific Technique
Level one	Data association	Figure of merit (FOM) Gating techniques
	Positional estimation	Kalman filters
Level two	Identity fusion	Bayesian decision theory Dempster-Schafer evidential reasoning (DSER)
	Pattern recognition	Adaptive neural networks Cluster methods
Level three	Artificial intelligence	Expert systems Blackboard architecture Fuzzy logic

The purpose of this state-of-the-art review is to provide a synopsis of the most predominant of these techniques. In the discussion that follows, these techniques are grouped by fusion level, differentiating them according to the nature of the information they provide. After each technique is introduced, its major applications are presented. Particular attention is given to cases that illustrate ITS or transportation applications.

Figure 1 provides a frequency distribution of the general methods used in approximately 50 U.S. military data fusion projects examined in Linn and Hall's 1991 review (see Table 2.1). Artificial intelligence techniques are the most widely applied general method of performing data fusion. Only three of these defense projects used pattern recognition methods (e.g., neural networks). This low number may indicate an underestimation of the importance of neural networks in the field of data fusion, given their voluminous coverage in broader engineering literature.

An annotated list of other state-of-the-art reviews is provided in Appendix B. Though various reviews of data fusion have been conducted, this document is the

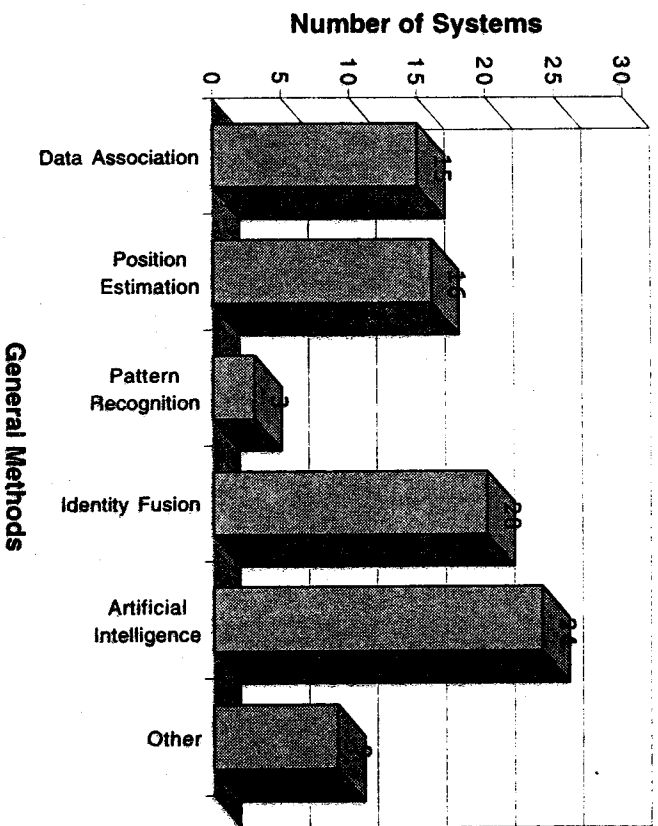

Figure 2.1: Frequency distribution of the general methods used in U.S. military data fusion projects (Linn and Hall, 1991).

first to specifically examine data fusion technology with an eye to its application in Intelligent Transportation Systems.

2.1. LEVEL ONE FUSION

2.1.1. Data Association

The first general method of combining multi-sensor data, known as data association, correlates one set of sensor observations with another set of observations. As a result of this process, data association is able to produce a set of "tracks" for a target object. A track is an estimate of a target's kinematics, including such factors as its position, velocity, and rate of acceleration (Hughes, 1989). Thus, data association represents the initial step necessary for localizing a target; this can later be enhanced with the identification of other characteristics associated with the target.

A fundamental challenge with data association is the task of deciding which observations should be combined into track estimates. Several methods have been devised to decrease the error probability of track estimation by eliminating data outliers, which are data observations that lie outside a specified confidence interval, typically 0.95 or 0.99. Two common techniques used to eliminate outliers are establishing a figure of merit (FOM) and gating. Both of these techniques work by selecting only those data observations that lie within a predetermined error threshold. One way to measure the distance between an established track for a target and a single observation in question is the Mahalanobis distance. This is the measured distance normalized by measurement and track error variances (Collins & Uhlmann, 1992).

In an in-depth state-of-the-art review of data association techniques employed in the aerospace industry, Blackman and Broida (1990) claimed that many of the issues encountered in aerospace applications are not unique to that field but are evident in other engineering domains, as well – including ITS. For more information on the leading techniques of data association developed in the past decade, see also Bar-Shalom and Fortmann (1987).

2.1.2. Positional Estimation: Kalman Filters

First reported in the ASME's Journal of Basic Engineering by R.E. Kalman (1960), this positional estimation algorithm has been widely used for a variety of optimization tasks. Transportation systems employing Kalman filtering use discrete-time algorithms to remove noise from sensor signals in order to better determine the present and future positions of a target (Bozic, 1979).

Kalman filtering produces fused data that estimate the smoothed values of position, velocity, and acceleration at a series of points in a trajectory (Sarma & Raju, 1991). Although no set of sensors can pinpoint a target with complete accuracy, the tolerance of each sensor's positional fix accuracy can be known and assigned. So Kalman filtering can be used to define a region of space within which an object is located (Hughes, 1989). The more narrow these spatial limits are kept, the better the estimation algorithm can perform.

Bayesian decision models that use *a priori* knowledge of a target's kinematic

motion characteristics are also integral to the Kalman filter algorithm. For example, Kim (1992) estimated target attributes by using Bayes' rule while making position estimates with Kalman filters. After each sensor observation is taken at a specified time interval, these observations are weighted according to their known accuracy level (Schlachta & Studenny, 1990). These weights are often inversely proportional to the variance of each sensor's response. Other approaches for dealing with dissimilarity in sensor tracking error are discussed by Haimovich et al. (1993).

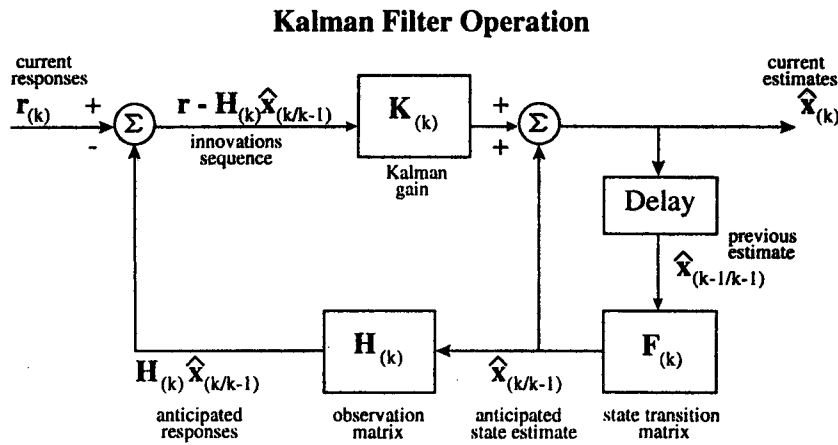

State Estimate Update:

$$\hat{x}_{(k/k)} = \hat{x}_{(k/k-1)} + K * (r_{(k)} - H_{(k)}\hat{x}_{(k/k-1)})$$

current estimate = anticipated estimate + Kalman gain * current response minus anticipated response

Figure 2.2: Calculations involved in a Kalman filter (Bahowick, 1990).

Like the Bayesian method, the Kalman filter algorithm can demand complex computations. Figure 2.2 shows the many calculations involved with a Kalman filter operation. This process is in many ways analogous to computing the half-life of a radioactive element (Bahowick, 1990).

Easthope et al. (1989) attempted to deal with the computational complexities of real-time Kalman filter design by introducing an object-oriented approach. Object-oriented programming can save much time in system development by compiling a library of modular, adaptive mini-programs.

2.1.3. Kalman Filters Applications

Little research has been reported in the United States on the specific application of Kalman filtering techniques to Intelligent Transportation Systems or to transportation systems in general. However, Kessaci et al. (1989) have used Kalman filters in Europe to estimate traffic-turning movement ratios based on data from magnetic loop sensors. Their work was performed on a project called PRODYN, a real-time, traffic-control algorithm tested in Toulouse, France. Kessaci et al. found that their Kalman filter estimation technique was both efficient and fast enough to be fully integrated into the PRODYN architecture.

In Germany, Behringer et al. (1992) tested Kalman filters to construct four-dimensional, position estimates for an autonomous driving system deployed on public roads in actual traffic situations. The computer architecture for the PROMETHEUS system, as it was called, consisted of modular clusters of 23 transputers that performed image analysis, feature extraction, object modeling, sensor data integration, and vehicle control. Researchers concluded that PROMETHEUS was able to successfully interpret roadway characteristics – even under real-time traffic conditions.

Other transportation-related research has been reported by Schlachta and Studdenny (1990), who used Kalman filters to improve the accuracy and reliability of an Omega-GPS (Global Positioning System) aircraft navigation system deployed in Canada. A global positioning system employs a network of Earth-orbiting satellites to calculate a subject's position and then transmit that information to the subject's GPS receiver; this technology has been widely applied in ITS projects. Though researchers acknowledge that Kalman filters are the current state-of-the-art in data fusion, they also recognize the difficulty of predefining a Kalman filter that is appropriate to a particular navigation problem.

Kalman filtering has been applied mainly in the field of robotics. Wen & Durrant-Whyte (1992) described their efforts to design a filter that is mounted on a robot arm and then used to locate a specific object. They recommended a model-based Kalman filter with previously-built-in constraints to recursively predict, match, and update a target's location. These constraints can be generated from a CAD-model

database. Moutarlier & Chatila (1989) developed a formal approach to incremental, three-dimensional map making and robot location by using a laser range finder and a stereo system. Their system sets up a unique reference frame wherein the location of all object frames and the robot are already known. The filter is able to cope with all kinds of correlations, including spatio-temporal ones. The system also accounts for anticipated filter biases.

In the field of general image processing, Durrant-Whyte et al. (1990) illustrated how a Kalman filter algorithm can be implemented to allow several cameras to track, in real time, a small object moving through a room. Their research focused on developing a thoroughly decentralized computer architecture, in hopes of eliminating the problems inherent in a centralized one. The major problem with a centralized communications system – one through which all messages between sensors must pass – is the communications and computational bottlenecks that inevitably develop. In addition, when one sensor breaks down in a centralized architecture the others are impacted as well. Durrant-Whyte et al. developed a fully decentralized architecture based upon a network of sensor nodes in which each node has its own processor.

Other researchers working on decentralized Kalman filtering as applied to military aircraft navigation claim that the positional error for a centralized architecture can be close to three times greater than that of a decentralized system (Broatch & Henley, 1991). The top diagram of Figure 2.3 depicts a centralized architecture, and the bottom diagram depicts a decentralized one.

2.2. LEVEL TWO FUSION

2.2.1. Bayesian Decision Theory

According to the Joint Directorate of Laboratories Data Fusion Subpanel, level two data fusion represents an advance beyond the creation of raw sensor data, as occurs at the first level, and supports the synthesis of more meaningful information for guiding human decision-making. Bayesian decision theory is one of the most common techniques employed in level two data fusion. It is used to generate a probabilistic model of uncertain system states by consolidating and interpreting overlapping data

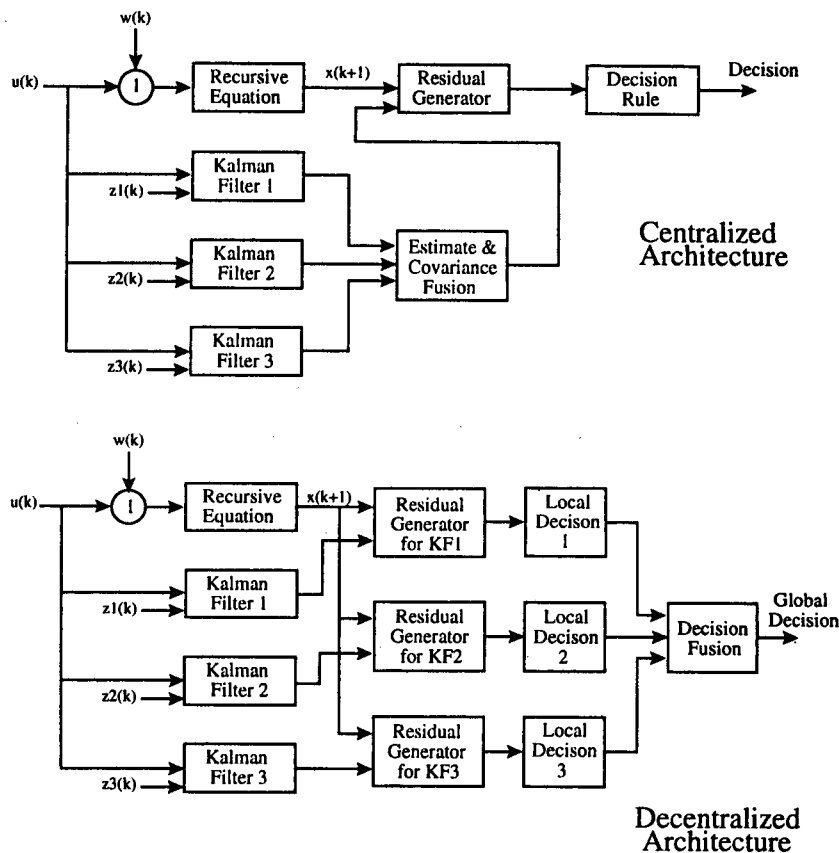

Figure 2.3: Centralized versus decentralized architecture (Belcastro et al., 1991)

provided by several sensors. It also determines conditional probabilities from *a priori* evidence; these revised probabilities are called "*a posteriori* probabilities."

The use of multiple sensors in data fusion projects can produce conflicting data which, in turn, can cause decision problems. Application of the Bayesian theorem in such cases has proven successful in overcoming this challenge. It models the unknown system state by using probabilistic functions to determine an appropriate set of actions (Cameron & Wu, 1991).

Without a probabilistic means of fusing data, sensors are only able to relay a binary "yes-no" response calculated on the basis of their own isolated, internal classification processes. This "yes-no" response can be termed a "hard decision" because it

reports no level of uncertainty back to the global data fusion center, only a definitive answer. The trouble with this method, according to Fennelly et al. (1992), is that a great deal of useful information is lost when sensors generate only “yes-no” inputs from collected data (see Figure 2.4) .

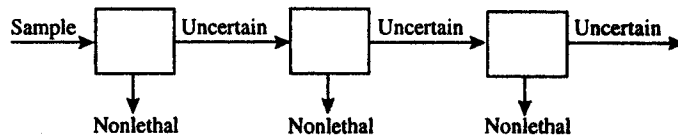

Figure 2.4: Decision support and classification model (Fennelly et al., 1992).

In addressing this problem, probabilistic data fusion generates what might be termed “soft decisions.” This process provides a greater measure of confidence by quantifying the uncertainty behind each sensor decision (Buede & Waltz, 1989). The composite evidence is then compared with some predetermined decision threshold level to arrive at a more accurate identification of unknown targets. Figure 2.5 shows the increased confidence level made possible by soft-decision sensors.

Several studies bear out the effectiveness of using the Bayesian theorem for identifying unknown targets. One study, Fennelly et al. (1992), reported a confidence level of 95 percent for an X-ray explosives-detection system that used five or six different soft sensors. These sensors, taken individually, averaged only about a 50 percent effective confidence level. The false detection rate for this system was 0.01 percent, and the cost of the system was much less than the price for a single-sensor approach with a corresponding 95 percent confidence level. The study also pointed out that a system of soft-decision sensors in a decentralized architecture is less likely to completely break down.

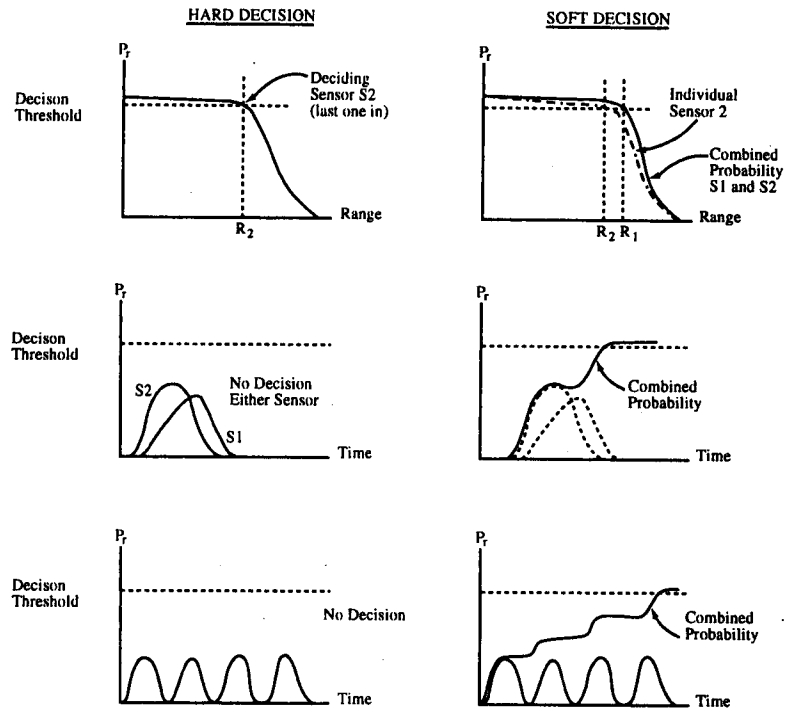

Figure 2.5: Increased confidence level made possible by soft-decision sensors (Buede & Waltz, 1989).

2.2.2. Bayesian Decision Theory Applications

Over the years, a substantial body of literature on Bayesian theory applications has been written. It is not too surprising, then, that a large number of data fusion projects use Bayesian uncertainty modeling as a data fusion strategy. Application of the Bayes theorem to the development of intelligent transportation systems, however, is still somewhat novel. An early example is the French PRODYN system, which uses a real-time, urban, traffic-control algorithm (see Section 2.1.2, Kalman Filters) to estimate traffic-related variables such as queues and road saturation levels (Kessaci et al., 1989).

Niehaus & Stengel (1991) have used probability methods to calculate traffic uncertainties for autonomous vehicles operating on limited-access highways. This project

was a recent expansion of their work on the IGHLC (Intelligent Guidance for Headway and Lane Control) system. IGHLC is a rule-based expert system that effectively models the concepts of worst-case decision-making to make provision for the most dangerous traffic situations, even if those events are not the most likely to occur.

Bayesian theorem implementation in data fusion is limited by this technique's inability to depict the level of uncertainty in a particular sensor state, as well as its inability to ensure consistency in a collection of interrelated propositions (Liu et al., 1992). Other frequently cited drawbacks of a probabilistic-based fusion algorithm are its heavy computer processing and memory requirements (Hoballah & Varshney, 1989).

The solution to these problems, according to Liu et al. (1992), is to assume statistical independence among each sensor's response and to derive a composite probability using only mathematical approximations. Hoballah and Varshney also recommended that the data from each sensor be treated as if they possessed an identical distribution. Hazlett et al. (1992) suggested using rules of mutual exclusiveness in order to reduce the computational burden; in order to distinguish between data that were either more certain or more significant, relative weights were assigned (Hazlett, 1992; Kim, 1992).

2.2.3. Dempster-Shafer Evidential Reasoning

As stated previously, Bayesian decision theory is limited in its ability to handle uncertainty in sensor data. This can hinder the application of this data fusion technique because sensor data are by nature highly uncertain. Uncertainty can come in many forms, including

- (1) incompleteness – sensors are likely to leave something out;
- (2) imprecision – sensors may provide only approximations;
- (3) inconsistency – sensor data may not always agree; and
- (4) ambiguity – data streams from various sensors may be indistinguishable from one another (Hughes, 1989).

Dempster-Shafer Evidential Reasoning (DSER) is now being explored as a productive alternative to Bayesian probability (Payne, 1993) because of its superiority in working with data uncertainty. DSER employs a confidence interval-of-certainty to replace the single-point probability of the Bayesian method. Sarma and Raju (1991) defined DSER as "a generalization of Bayes reasoning that offers a way to combine uncertain information from disparate sensor sources." One major advantage of DSER is that sensor data can contain varying levels of abstraction, meaning that "...each sensor is allowed to contribute information at its own level of detail."

The Dempster-Shafer method has several other advantages over Bayesian decision theory (Hughes, 1989). Most importantly, hypotheses do not have to be mutually exclusive, and the probabilities involved can be either empirical or subjective. Because DSER sensor data can be reported at varying levels of abstraction, *a priori* knowledge can be presented in varying formats. It is also possible to use any relevant data that may exist, as long as their distribution is parametric. Hughes further claimed that the Dempster-Shafer theory enables switching from probabilistic techniques to logical techniques when hypotheses become almost entirely true or false (Hughes, 1989).

2.2.4. DSER Applications

Despite its considerable advantages over the Bayes method, the only references to the application of DSER in transportation systems are those of Harris (1988) and Harris and Read (1989) in their work on autonomous guided vehicles (AGVs). These fully autonomous vehicles utilize on-board intelligent sensors to determine both the state of the vehicle and the outside driving environment.

The majority of research involving DSER is connected with general object recognition (Zhu et al, 1992; Lui et al., 1992; Lee & Leahy, 1989). Some of this work examined the usefulness of DSER techniques for tracking moving objects, as in the research of Chao (1990), Chao et al. (1990), and Puente et al. (1991). Chao (1990) applied the Dempster-Shafer theory in his development of a knowledge-based, moving-target detector that identifies feature parameters using radar signals. Puente et al. compared the Bayes method to DSER in robot collision, danger-risk monitoring. This project, conducted in Madrid, Spain, was dubbed the Esprit-2483 Panorama Project.

As one might expect, application of the Dempster-Shafer method demands extensive computational capabilities. In fact, Puente et al. claimed that the computer memory requirements for DSER are double that of the Bayesian single-point probability method. Other shortcomings of the Dempster-Shafer method, according to Zhu & Lee (1993), include the manner in which it handles conflicting information and its reliance on the basic assumption that two pieces of evidence must have the same population universe.

2.2.5. Neural Networks

Neural network technology has had a growing impact in the industrial and military sectors since the 1980s. An artificial neural network can be explained as a web-like, information processing structure that emulates the human brain's own learning and decision-making processes. Like Bayesian or DSER techniques, neural networks produce interpretive findings that incorporate input from various weighted, information sources. One major advantage a neural network decision algorithm has over either Bayesian or DSER methods is its capability to perform data fusion processing without the need for *a priori* information (Butini et al., 1992). But the real power of a neural network is its ability to process incoming data streams simultaneously rather than sequentially, as occurs with more traditional computing systems (DeClaris, 1992).

A neural network uses many simple elements called neurons (or processing nodes) to collect and correlate information. These neurons are connected by synapses that ascribe a weight to each neuron's output and then forward it, in a unidirectional path, to the next set of neurons. A neuron may have many inputs, but it has only a single output. In summary, the three defining elements of a neural network are the following:

- The neuron's characteristics - the equations that define what a neuron will do.
- The learning rule - the guide as to how the weights between various neurons will change according to the stimuli they receive.
- The network topology - the manner in which the neurons are connected.

Neural networks always require a “learning” period in order to fully establish and test the specific patterns or rules that will guide the system. The learning process employed in a typical multi-layer neural network is simple error feedback (Bavarian, 1993). During this process, the network must be run through its paces so that each neuron can be “taught” the proper association between diverse data inputs and assimilated output. This knowledge can be obtained through the observations of a human teacher, who repeatedly programs the desired weights given to each neuron until a known pattern is fully duplicated (DeClaris, 1992). Some of the most modern neural networks employ a topology that promotes self-learning through a preprogrammed learning algorithm.

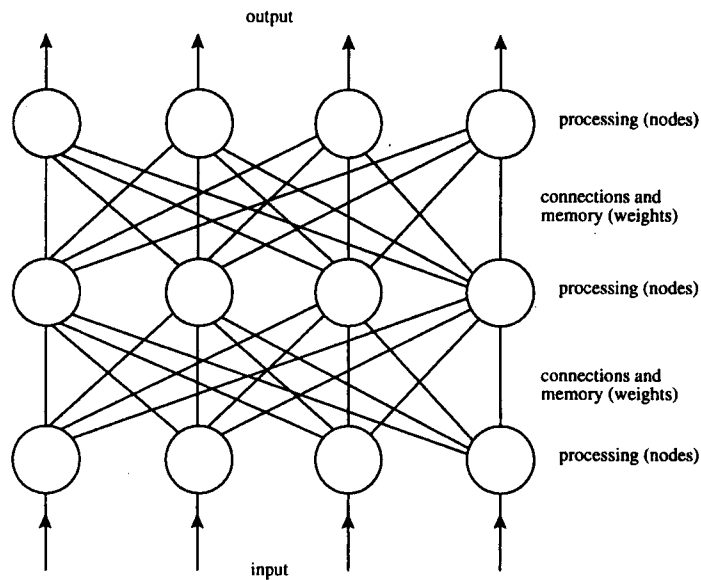

Figure 2.6: Architecture of the original genre of neural network systems (DeClaris, 1992).

Figure 2.6 depicts the architecture of the original genre of neural network systems, also known as a perceptron. The multi-layer architecture of the perceptron incorporates four main functions: input/output (data transfer in and out of the computer), processing (executing specific information-handling tasks), memory (storing information), and the connections between the neurons (providing for information flow and

control).

2.2.6. Neural Networks Applications

During the past decade, several successful prototypes of neural network systems have been developed and implemented in a wide range of artificial intelligence applications. These have taken on such tasks as the generation of national weather forecasts and stock market predictions. Ford Motors has recently designed a neural network that can read sensor data from automobile engines and determine the probable cause of a malfunction (Chang, 1992).

One common concern being addressed by several ITS projects is the challenge of accurately and quickly detecting traffic incidents. In a research project for the Texas Transportation Institute at Texas A & M, Chang (1992) used a neural network to improve computerized traffic surveillance and automatic incident detection. The system, called Brainmaker, pattern-matched current traffic situations against historical information, especially during periods of high congestion or major traffic incidents. The author lists three key measures of system performance: the proportion of total incidents detected, the false alarm rate, and the average time taken to detect an incident. Chang found his own neural network algorithm to be "reasonably fast and 83 percent accurate," though its effectiveness was dependent on the accuracy of the traffic detector data used in training the neurons.

One of the more ambitious ITS projects in the U.S. is ADVANCE, an acronym for Advanced Driver and Vehicle Advisory Navigation Concept (Kirson et al., 1992; Boyce et al., 1991). ADVANCE is a driver information system that just finished testing in the suburban Chicago area at the end of 1995. It is the first dynamic route guidance system of its kind in North America and has been sponsored by several public and private agencies, including the Federal Highway Administration (FHWA), the Illinois Department of Transportation, Motorola, Inc., and major Illinois universities.

Designers involved with the ADVANCE program have proposed using a neural network along with a knowledge-based expert system (see next section) to perform the necessary artificial intelligence functions (Kirson, 1992). The authors plan to use a KBES for the incident-detection algorithm and a neural network to fuse the output.

They explain that a neural network is helpful in solving pattern recognition problems that involve many potential interrelationships that are not easily recognized.

Other transportation-related applications include Nijhuis et al. (1991), who employed neural networks in addressing car collision avoidance problems, and Kraiss and Kuttelwesch (1991), who tested and proved that neural networks are applicable as vehicle operator models in a two-lane car-driving task.

Neural networks are being applied to many non-ITS projects as well. One such application is in the U.S. Navy for autonomous ship navigation through a channel (Stamenkovich, 1991). The basic learning routine of this simple network is termed "learning with a critic." The network consists of only two neurons, one that explores the channel region through which the ship is navigating and another that critiques the actions of the first. System "forgetfulness" may be attributed to the small number of neurons incorporated in this model (Stamenkovich, 1991).

A frequent focus of other non-ITS applications of neural networks is the usefulness of such systems for image processing, including exploration of the Earth's surface from a satellite (Lure et al., 1993); identification of an object based on each neuron's area of expertise regarding texture, motion, or depth (Booth et al., 1991); and image recognition problems in general (Fincher & Mix, 1990).

2.3. LEVEL THREE FUSION

2.3.1. Expert Systems

The most commercially successful branch of artificial intelligence is the field of expert systems. Knowledge-based expert systems (KBES) are a branch of artificial intelligence that strives to emulate the behavior of a human expert working within a well-bounded domain of knowledge (Liebowitz, 1988). So expert systems are, by definition, level three fusion techniques because they provide users with higher-level, informed recommendations for guiding human decision-making.

Typically, an expert system has three major components: the dialog structure, the inference engine, and the knowledge base. The dialog structure is the interface between the user and the system. These interfaces are designed to verbally explain

their reasoning, much like a human expert. The inference engine “drives” the computer to perform search strategies that arrive at various conclusions. The inference engine reasons in one of two ways: by forward chaining (which is driven by the data) or backward chaining (moving backward from the goal to the steps that need to be taken to accomplish that goal). The third component of an expert system, its knowledge base, is the set of facts and rules (heuristics) that guide a specific task at hand. These rules are usually constructed in the form of “IF-THEN” statements, but other knowledge representation methods are used, too.

The true power of an expert system lies in its knowledge base, which also represents its biggest challenge because knowledge engineering is fraught with many difficulties. The first step in developing a knowledge base is to select an appropriate problem to be solved. Liebowitz (1993) offers the following suggestions:

- Pick a problem that is costing people a fair amount of time and money.
- Select a well-bounded problem whose solution can be encoded in a knowledge representation scheme.
- Select a task that is performed frequently.
- Choose a problem for which a general consensus exists on the proper solution.
- Pick a task that utilizes symbolic knowledge, such as “IF-THEN” rules.

The often painstaking process of acquiring knowledge for the expert system task can be simplified if developers choose an application for which a cooperative expert or set of experts exists. Many times, the majority of needed information has already been documented. Liebowitz (1988) cautioned that it is not always easy to find an expert who is articulate and readily available. One final limiting factor to expert system technology that is often overlooked until it is too late is the process of transferring the technology to its intended users. To ensure final product acceptance, user comments and confidence must be sought from idea conception to system changeover.

2.3.2. Expert Systems Applications

Expert systems have been applied to a variety of tasks ranging from sheep reproduction management in Australia, to boiler plant operation in Japan, to strategic management consulting in Europe (Liebowitz, 1993). Because of the wealth of literature available on this subject, the set of examples provided in this section will be limited to ITS applications or illustrations from the field of transportation.

In ADVANCE, the driver information system currently being tested in Chicago (see section 2.2.5, Neural Networks), the developers have been using a KBES for the incident detection algorithm because its rule-based structure enables more direct control over system design (Kirson, 1992). Furthermore, the expert system was relatively simple to develop because the required knowledge could be culled from a human expert. Figure 2.7 depicts the high-level architecture of ADVANCE.

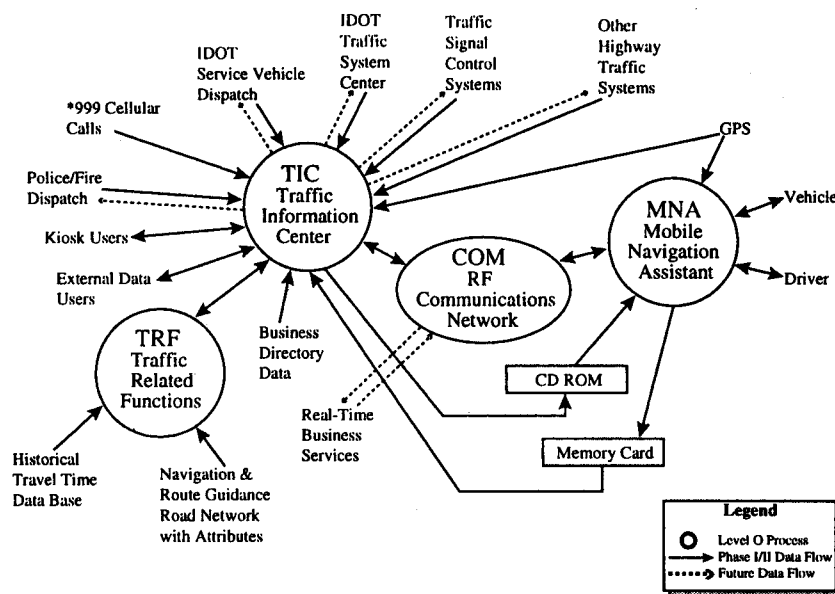

Figure 2.7: Architecture of ADVANCE (Kirson et al., 1992).

As shown, ADVANCE has four major components (Kirson et al., 1992):

- Mobile Navigation Assistant (MNA) - determines a vehicle's position, performs route planning, and provides route guidance information to the driver

- RF Communications Network (COM) - provides two-way radio communications between the Traffic Information Center and the MNAs in the vehicles
- Traffic Information Center (TIC) - houses the central computer facilities and controls the Traffic Related Functions
- Traffic Related Functions (TRF) - comprises the traffic data and analytic functions on which ADVANCE is based.

The data fusion system, incorporated in the TRF, correlates traffic probe reports and feedback from street signals with historical transit data to provide travel-time estimates for probe vehicles. Kirson et al. proposed using a knowledge-based expert system as the incident detection algorithm to identify abnormal traffic conditions. The authors explained that the rule-based structure of a KBES would allow developers to exert direct control over system design and to more rapidly validate system results (Kirson et al., 1992).

As mentioned in the article "Bayesian Decision Theory," researchers Niehaus and Stengel (1991) designed a real-time expert system that guides autonomous vehicles on limited-access highways. The inputs to their Intelligent Guidance for Headway and Lane Control system (IGHLC) included the coordinates and velocity of the driver's vehicle and surrounding traffic, the road geometry, current road conditions, and driver-selected target cruising speeds and levels of safety. The job of the expert system is to analyze all this information and then provide appropriate driver commands. Figure 2.8 shows an example of the expert system logic in an IGHLC system.

Two additional examples of expert systems used in ITS projects include the European projects PROMETHEUS (see also Section 2.1.2, Kalman Filters) and DRIVE (Martinez et al., 1990). The aim of both projects was to develop an expert system that can function as a car co-pilot. An expert's knowledge of the driving environment was analyzed by system designers, who decomposed the driving task into several independent subtasks. These independent subtasks were then allocated to individual neurons in a neural network trained to recognize dangerous driving situations in real time. Researchers found that the knowledge-based neural networks employed in both projects improved the systems' performance (Martinez et al., 1990).

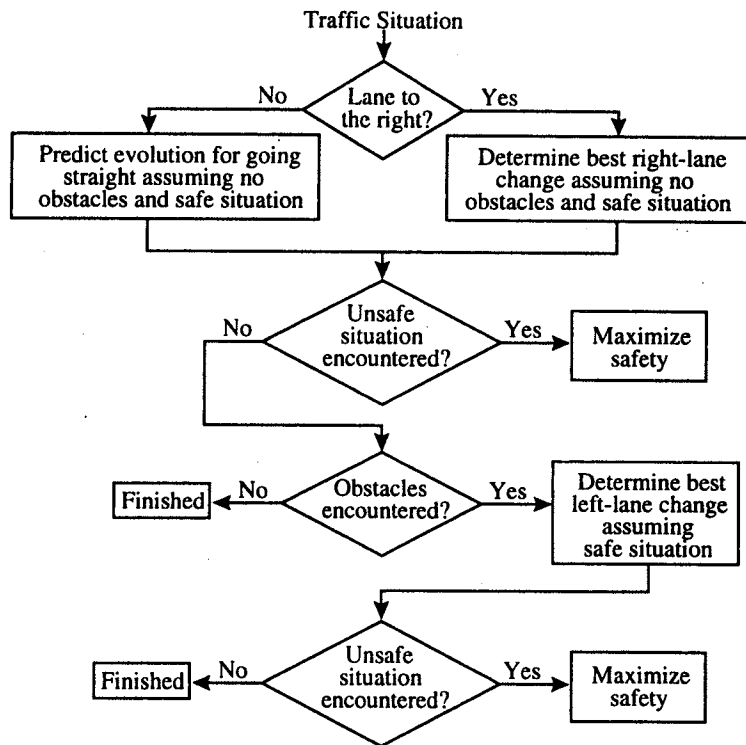

Figure 2.8: Expert system logic in an IGHLC system (Niehaus & Stengel, 1991).

2.3.3. Blackboard Architecture

Many of the newer expert systems have components in addition the three main elements mentioned above (the dialog structure, the inference engine, and the knowledge base). One component that is sometimes employed is a “blackboard,” which is a global database used for temporarily recording any intermediate decisions made by the system. Typically, the blackboard keeps track of three types of decisions, known as the plan, the agenda, and the solution (Hayes-Roth, 1992). The “plan” is the overall strategy for solving the current problem; for example, the plan may recommend processing all low-level sensor data first. The “agenda” keeps a record of the actions yet to be taken. The “solution” represents the hypotheses that the system has generated thus far. Blackboards have been implemented successfully in a variety

of expert systems, including speech recognition, computer vision, and many types of military applications. Some researchers in the artificial intelligence community regard blackboard systems as the most promising scheme for the next generation of knowledge-based systems (Maitre et al., 1990).

2.3.4. Blackboard Architecture Applications

At this time, the engineering literature contains no examples of a blackboard architecture applied to ITS data fusion projects. But a blackboard architecture has been applied to general transportation issues in the work of Capocaccia et al. (1989) of Italy, who used expert surveillance to detect unexpected objects found at railroad crossings. In this project, called ATOME, the blackboard was used for both inference and control functions. Specifically, the authors describe a method for merging data coming from two channels of the same color video camera. These channels provided two images of different intensity, one being the actual scene and the other the "normal" background.

Another transportation-related project that employed a blackboard system was that of Leardi et al. (1990), again of Italy, whose Distributed Object-Oriented Multi-sensor Recognition System (DOORS) was used to guide an autonomous vehicle through natural outdoor scenes. DOORS is composed of a set of modules in which each module possesses the procedural knowledge to build up an interpretation of the viewed scene at a specific level of abstraction.

Many blackboard systems have been used in military expert systems applications. For example, Brogi et al. (1989) used a blackboard prototype to merge reports from radar and other sensors with *a priori* information. The authors claimed that the major advantage of a blackboard architecture is that it enables system developers to partition the domain knowledge of the expert system into cooperating modules. This knowledge can then be kept separate from control knowledge. Figure 2.9 illustrates how domain knowledge (left) is separated from control knowledge in a blackboard system.

Other military projects that have incorporated blackboard architectures include the work of Sikka et al. (1989), whose system was able to classify five different

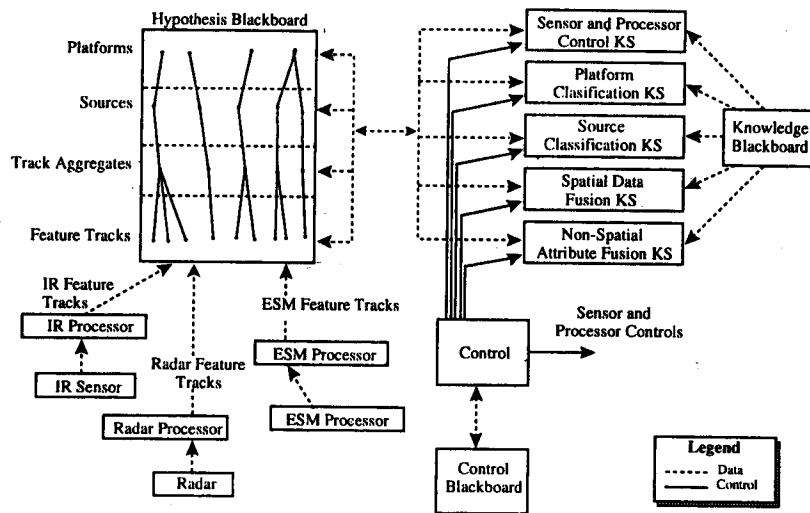

Figure 2.9: Sample blackboard architecture (Leung & Williams, 1991).

aircraft by identifying their distinctive features, and Llinas (1993) who attempted to formulate a generic, ideal blackboard for certain defense applications.

2.3.5. Fuzzy Logic

Many expert system developers are building their machine knowledge – that is, their IF-THEN decision rules – on the rapidly growing engineering discipline of fuzzy logic. Fuzzy logic is a type of set theory that mathematically describes objects or processes that cannot be categorized into “0-1” binary code. Thus, fuzzy logic is highly valued for its ability to integrate “fuzzy” human reasoning processes with the precision of the computer. The concept of fuzzy logic is similar to Dempster-Shafer evidential reasoning, in that it is another means of dealing with data uncertainties. The data handled in fuzzy systems are often referred to as “soft” data. They are intended, for example, to describe ambiguous classifications such as big, small, rich, poor, fast, and slow.

The mathematics of fuzzy set theory originated in 1965 with L.A. Zadeh, who developed a calculus of fuzziness that assigns objects or concepts to an interval scale

between 0 and 1; the minimum value is “0” and the maximum value is “1.” The mathematical operators available to fuzzy reasoning systems are the same as those used in traditional set theory: logical connectives such as AND and OR, the complements X and NOT X , and mathematical products or algebraic sums (Gupta, 1992). Additionally, the concept of partial set membership also makes possible other mathematical operations not normally found in traditional set theory. Two of these operations include concentration, which is used to delineate a sharp boundary for a fuzzy set, and dilation, which provides a more flexible boundary. Figure 2.10 illustrates the fuzzy logic involved with classifying rainfall in a certain geographical region.

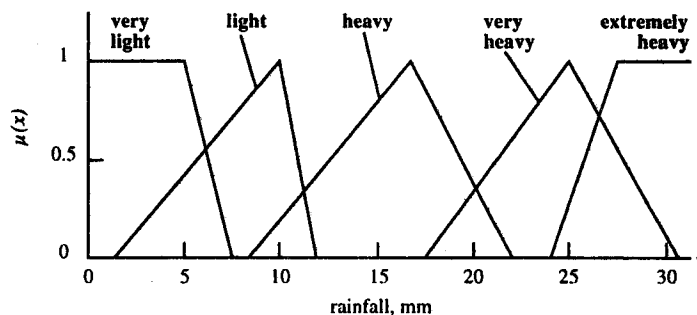

Figure 2.10: Fuzzy logic involved with classifying rainfall (Gupta, 1992).

2.3.6. Fuzzy Logic Applications

Fuzzy set logic is used in an array of decision and control applications: economic and management decision-making, medical diagnostic processes, enhancement of human perception, and large-scale engineering systems (Gupta, 1992). Transportation-related applications of fuzzy systems have been designed for measuring automobile speeds and congestion levels, operating automatic trains using predictive logic, and selecting paths in autonomous vehicle navigation systems (Harris, 1988; Harris & Read, 1989).

The first two ITS implementations that employed fuzzy set logic in the United States were called Pathfinder and TravTek (Mammano & Sumner, 1989; Mammano & Sumner, 1991; Sumner, 1991; Rillings & Lewis, 1991; Case et al., 1991). Pathfinder was implemented in Los Angeles and TravTek in Orlando, Florida. With each of these systems, fuzzy logic permits traffic conditions to be described through qualitative measures such as "no congestion," "congested," "minor incident," or "major incident," instead of the less descriptive binary outputs of "congested" versus "uncongested." The data fusion algorithm in the two systems must be able to handle several hundred traffic "links" or junctions every minute, 24 hours per day. According to Sumner, two major problems are associated with fusing all these data: first, the data age at different rates, and, second, the quality of information varies according to the reliability of the source.

The fuzzy logic process in Pathfinder and TravTek is constantly evaluating which of six data sources will be given priority in determining system outputs. First, each of the six sources is assigned a quality value based upon its record of reliability. At any given moment, the final score for each source is determined by linearly decrementing the quality of the source score by the age of the data. When the duration of a traffic event is extended, as in the case of an accident or freeway back-up, a human operator or the fusion algorithm can override this aging factor.

2.4. STATE-OF-THE-ART SUMMARY

The role of level three data fusion processes is to transform high-volume, raw sensor data into low-volume, high-level information. Knowledge-based expert systems of one form or another predominate in these instances. But before any high-level information can be generated, the raw data from level one fusion must be provided via a Kalman filter algorithm or various methods of data association. The meaning to be gained from these raw sensor data is constructed using various probabilistic methods, such as Bayesian decision theory or Dempster-Shafer evidential reasoning. Neural networks are fast emerging as another alternative to Bayesian decision theory because of their ability to process complex information in parallel. Although the engineering literature

Table 2.2: Acronyms for leading ITS data fusion projects

Acronym	Full Name	Locations
ADVANCE	Advanced Driver and Vehicle Advisory Navigation Concept	Chicago, Illinois
AGVs	Autonomous Guided Vehicles	United Kingdom
Brainmaker	Metaphor referring to the human brain	Texas A&M
DRIVE	Dedicated Road Infrastructure for Vehicle Safety in Europe	Pan-European
IGHLC	Intelligent Guidance for Headway and Lane Control	Princeton University
Pathfinder	A descriptive label	Los Angeles, California
PRODYN	Dynamic Programming	Toulouse, France
PROMETHEUS	Program for European Traffic with Highest Efficiency and Unprecedented Safety	Pan-European
TravTek	Travel Technology	Orlando, Florida

is replete with examples of how these data fusion techniques are being applied in military and industry projects, they are just now beginning to be applied to ITS projects.

Table 2.2 summarizes the leading ITS data fusion projects discussed throughout this report.

Table 2.3 provides a synopsis of how the leading data fusion techniques described in this report have been bundled together in key ITS projects. These projects are listed according to the date of publication of the articles in which they were described. Note that the year given in column two represents the date the article was published and not necessarily the date the ITS project was completed. Therefore, one must keep in mind that some of the data fusion techniques listed in Table 2.3 may not actually have been implemented in the final version of the ITS project cited. As Table 2.3 shows, the latest data fusion projects are typically more robust than the ITS prototypes of the late 1980s.

Table 2.3: Summary of fusion techniques as applied to ITS

Project (Author)	Year	Technique(s)	Purpose
ADVANCE (Kirson et al.)	1992	Kalman filter Neural network Expert system Fuzzy logic	Forecasts future traffic conditions Pattern-matches current traffic situations with historical situations Identifies abnormal traffic conditions Permits traffic conditions to be described with qualitative measures rather than simple "yes-no" responses
PROMETHEUS (Behringer et al.) (Martinez et al.)	1992 1990	Kalman filter Expert system Neural Network	Constructs 4-D position estimates for autonomous driving Decomposes a driving task into independent subtasks Allocates one neural net for each driving subtask
Brainmaker (Chang)	1992	Neural Network	Pattern-matches current traffic situations with historical situations
IGILC (Niehaus, Stengel)	1991	Kalman filter Bayesian Expert system	Determines vehicle position Deals with traffic uncertainty Models concepts of Worst-Case Decision Making
Pathfinder (Sumner)	1991	Fuzzy logic	Permits traffic conditions to be described with qualitative measures rather than simple "yes-no" responses
TravTek (Sumner)	1991	Fuzzy logic	Permits traffic conditions to be described with qualitative measures rather than simple "yes-no" responses
DRIVE (Martinez et al.)	1990	Expert System Neural network	Decomposes a driving task into independent subtasks Allocates one neuron for each driving subtask
PRODYN (Kessaci et al.)	1989	Kalman filter Bayesian	Estimates traffic-turning movements Estimates traffic-state variables, e.g., queues and saturation
Application to AGVs: Autonomous Guided Vehicles (Harris & Read)	1989	DSER	Determines state of AGV and outside world
(Harris)	1988	Fuzzy logic	Effectively controls AGV's lateral motions in real time

3. DATA FUSION: LOOP DATA FLOWS

The initial sections of this report have outlined the current state-of-the-art for data fusion systems, with a special focus on their use in ITS projects. This section examines a specific data fusion application developed at the UW that uses the WSDOT Traffic Systems Management Center (TSMC) traffic management system (TMS) as the data source. Two main goals have been identified for the UW research effort. One is to gather traffic congestion information from all available sources in order to make reliable traffic predictions. Another is to support travelers by providing them with up-to-the-minute information on highway congestion to help guide their transit decisions. These have been accomplished by using occupancy and roadway volume data gathered from the TSMC traffic management system to estimate approximate vehicle speeds. These data are then displayed on ITS digital maps that travelers can use to guide their trip decision-making.

Figure 3.1 shows the current architecture of the UW traffic data fusion system. There are four major parts to the system architecture. The first part is the TMSUW server that was put on the TSMC's VMS machine, identified as HARLEY. This server collects the available loop data from the real time database's (RTDB) main memory. After collecting the data, it broadcasts those data to a local area network at the TSMC, where another machine "listens" to the broadcast port.

The second part of the system is the server called LOOP REBROADCAST. This server resides on the machine called LOOPS, which is hooked into the local area network (LAN) at the TSMC. LOOP REBROADCAST was put on LOOPS rather than on the TSMC's VMS, HARLEY, to avoid possibly disturbing that system and slowing down its processing. The purpose of this server is to collect the broadcast data from TMSUW on VMS. Each data packet is then sent via a T1 link to the server LOOP REPEATER running on a machine located at the University of Washington

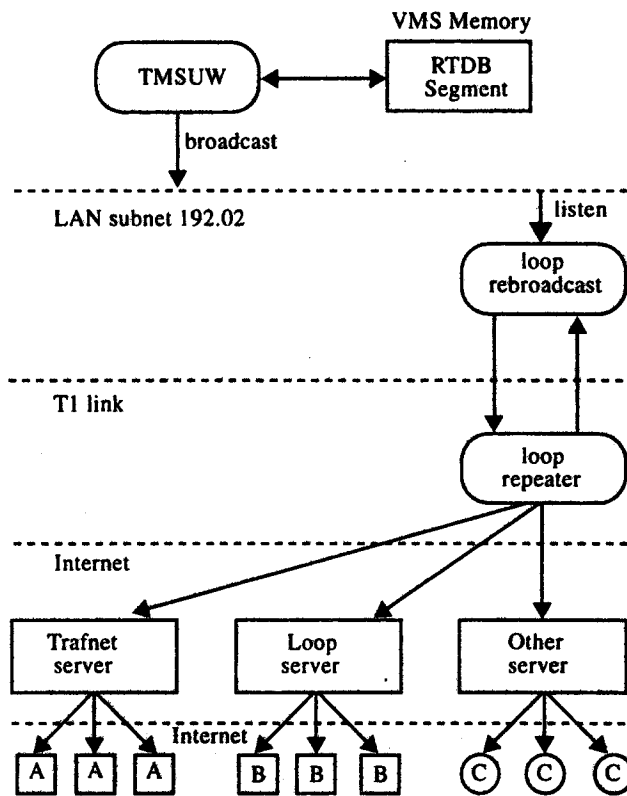

Figure 3.1: Architecture of the TSMC traffic reporting system.

(UW).

The third part of this system, just mentioned, is the server called LOOP REPEATER. The purpose of LOOP REPEATER is two-fold: it reduces the load on the LOOP REBROADCAST server, and it allows transmissions along the T1 telecommunications link to stay within capacity limitations. This arrangement also provides for future expansion of the system. LOOP REPEATER can be cascaded to increase the total number of users that can be accommodated.

The fourth component of the system is the server needed to provide information to end users. This task is handled by LOOP SERVER, which transmits occupancy and volume data for each loop and station; it also transmits information on the

average speed and length for each speed trap. The TSMC traffic reporting system is configured so that servers can be added to handle different end user requests.

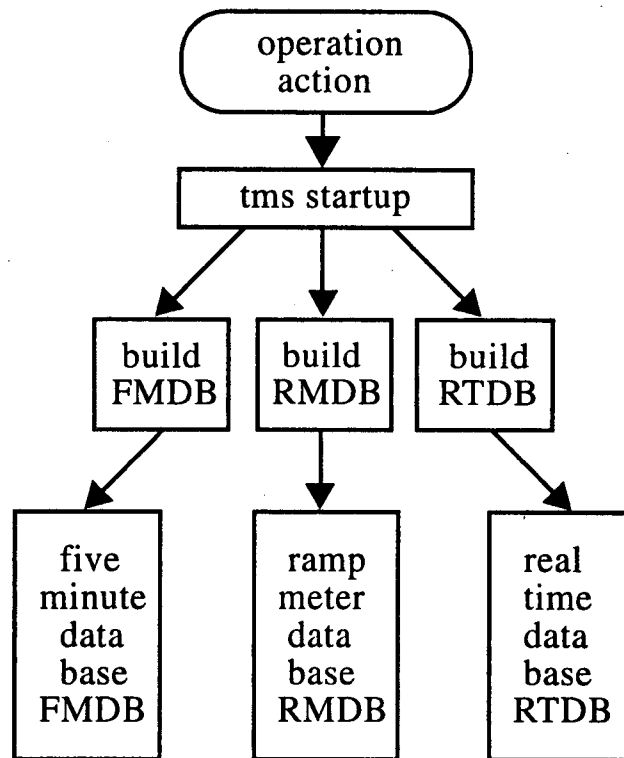

Figure 3.2: TSMC global memory databases.

3.1. TMSUW ON HARLEY

As mentioned above, the TSMC traffic reporting system runs on a VAX machine called HARLEY at the TSMC. Upon starting, it builds several global memory databases, as shown in Figure 3.2. Three global databases are available: TMS_RTDB (real time database), TMS_RMD (ramp meter database), and TMS_FMDB (five-minute database). All of these global data sections are accessible, but the loop information is taken from the RTDB, which is updated every 20 seconds. The two other databases are based on the RTDB data but are normalized for different purposes. The actual

RTDB memory data block allocation contains two parts (see Figure 3.3). The first part is a name table that contains information on loop names and their offset in each 20-second data record. The second part contains 181 20-second data records. Each record represents the complete loop recorded in a specific time (every 20 seconds).

- Name Table: The name table contains all the loop names currently available in the RTDB. Each name is a combination of a cabinet name and a specific loop name. For example, "ES090D:MN__1" is the loop in cabinet "ES090D," and it is on the main, north-bound lane number 1. The name table also contains information about the loop type. Three types are currently implemented. One is loop, one is station, and one is speed trap. A field also specifies the length of the loop, because all three types of data are not the same size. Finally, the field "offset" points to the correct position of the data associated with the loop name.
- Data Record: The RTDB data record is updated every 20 seconds. One hour's worth of data equals 181 (60 x 3+1) records. When the RTDB data record is updated, the data just received from traffic reporter is put in the "new" data block; all the other data blocks shift one slot over towards the newest data. As a result, one hour's worth of data is kept within the new data block. In other words, every 20 seconds each data record rotates to the next data record slot, leaving room for most the current data to be put in the "new" data block, and the oldest data record is automatically discarded. After rotation, the rotation scroll number in global memory is increased by one.

The program TMSUW first reads the name table from the RTDB global memory and then writes it into a file. After writing the file, it starts the data collection cycle. The program maps to the global section of the RTDB database in each cycle and then sets up the corresponding pointers for each data block. It also calls the VMS set event system to calibrate the event flag at 20 seconds, which directs it to start a new collection cycle every 20 seconds. After the event is set for every 20 seconds, the program checks the global scroll value in the RTDB database to find out whether the

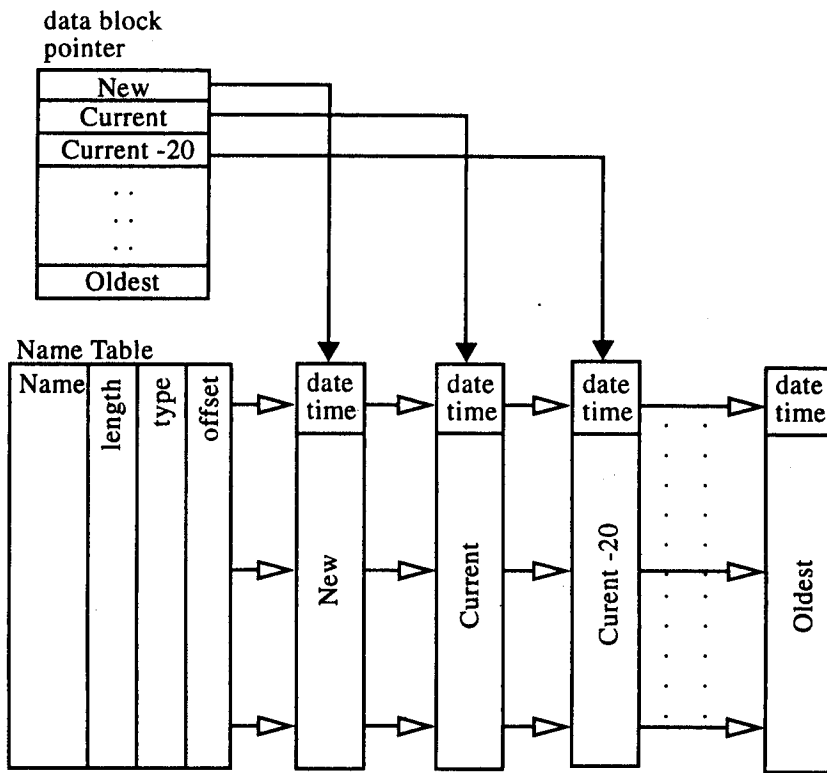

Figure 3.3: RTDB memory data block allocation.

data records have rotated. If data rotation has occurred, it means a new set of data have been received and put into the “new” data block. Otherwise, the system is reset by traffic reporters.

In the first case, when a new set of data have been put into the “new” data block, the program collects the “new” data record, broadcasts it over the LAN in the TSMC, and finishes the collection cycle. The program then goes to the start of the collection cycle and waits for the next 20-second event. However, if the program discovers that the system has been restarted, it will wait a few minutes to ensure that the system successfully restarts and then will broadcast a special packet to the LAN. This special data packet lets the LOOP REBROADCAST server know that the TMSU report system has been restarted and that LOOP REBROADCAST needs to update the name table file. Figure 3.4 provides a flow chart of the TMSUW process.

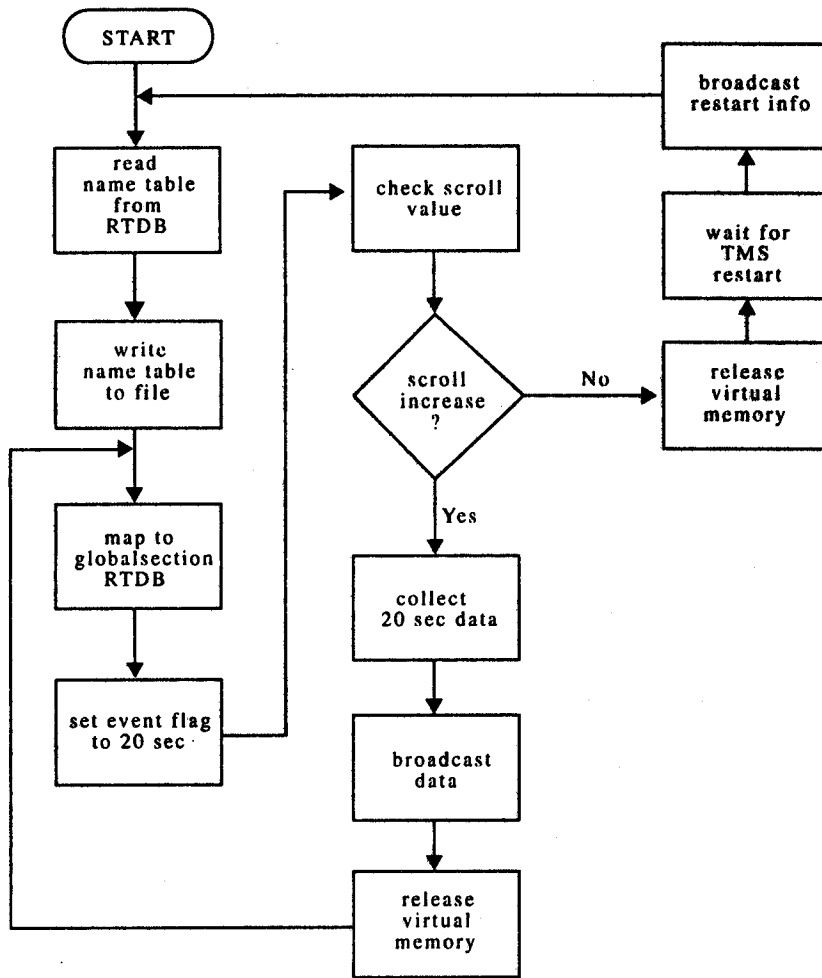

Figure 3.4: Flow chart of the TMSUW process.

3.2. LOOP REBROADCAST SERVER

The server residing on the TSMC VMS machine broadcasts loop data over the LAN at the TSMC every 20 seconds. The LOOP REBROADCAST server running on the machine and hooked into the TSMC VMS monitors the LAN (subnet 192.0.2) to determine whether a broadcast data packet is available. The system architecture of the LOOP REBROADCAST server can be divided into three components, as shown in Figure 3.5. When the LOOP REBROADCAST server is started, it generates three child processes to handle the different requests of the server:

- Child Process Number 1: This process listens to the LAN to determine whether broadcast data are available. If they are, it sends the received data packet to child process number 3.
- Child Process Number 2: This process handles all the connection requests from other programs. After a connection has been accepted, it sends information about the remote program (such as an IP address or socket port number) to child process number 3. The only connection currently in place is the one to the LOOP REPEATER server, but the system is capable of accepting other connection requests.
- Child Process Number 3: This process actually sends the data packet received from child process number 2 to all the connection sockets. It also receives the broadcast data packet from child process number 1 via UNIX socket pipes. When data from process number 2 are received, it adds the information of remote end to the client list. When data from process number 1 are received, it sends the data packet to all clients on the client list.

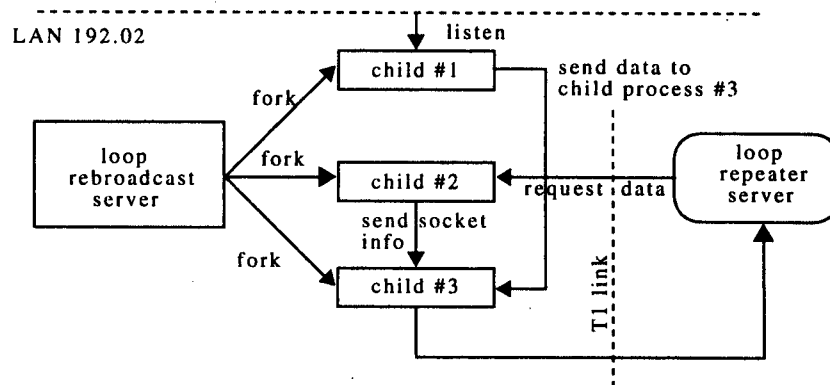

Figure 3.5: LOOP REBROADCAST server components.

3.3. LOOP REPEATER SERVER

The LOOP REPEATER server is similar to the LOOP REBROADCAST server. One difference is that the LOOP REPEATER requests a connection to the LOOP REBROADCAST server, whereas the LOOP REBROADCAST server monitors the LAN for broadcast data packets. A second difference is that the LOOP REPEATER server connects directly to the Internet rather than connecting to the UW via a T1 link. As a result, it has a greater capacity for handling a large number of clients. This was the main reason for establishing the LOOP REPEATER server. Another advantage of running the LOOP REPEATER is that it will allow for system expansion, because several loop repeater servers can be linked in a cascading configuration to handle hundreds of client data requests. Figure 3.6 shows the system architecture of the LOOP REPEATER server.

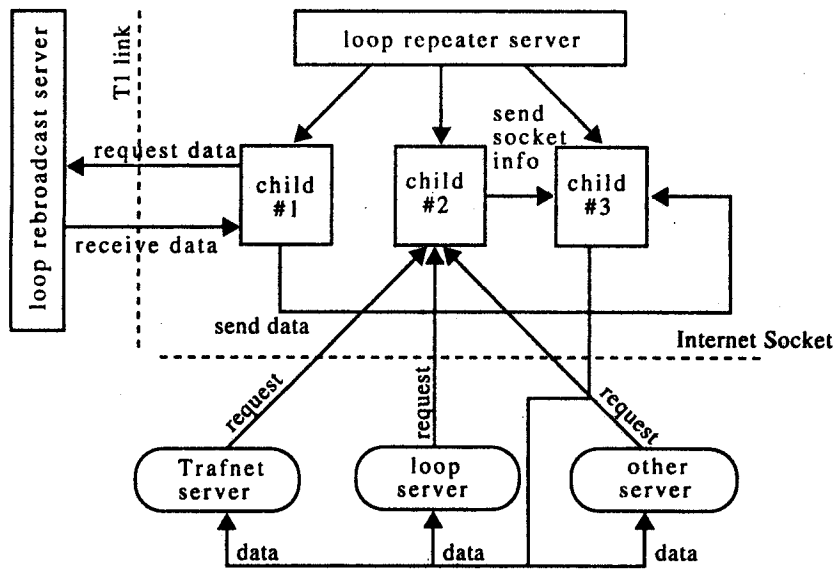

Figure 3.6: Architecture of the LOOP REPEATER server.

3.4. LOOP SERVER

The LOOP server provides clients with occupancy, volume, average speed, and average length traffic-related information. This server accepts connection requests from all interested clients. It also accepts user requests for specific loop data. When started, the server generates three child processes, each of which handles different connection requests and manages different data sets, as requested by clients. The system architecture is shown in Figure 3.7. The three child processes associated with the LOOP server are described below.

- Child Process Number 1: The first child process makes a connection request to the LOOP REPEATER server and requests a raw data packet. The connection remains in place after it has been established as the LOOP server waits for the RTDB 20-second data update. Upon receiving a data packet from the LOOP REPEATER server, the LOOP server sends the data packet to child process number 3 via UNIX socket pipes.
- Child Process Number 2: The second child process of the LOOP server handles all connection requests from end users who are interested in receiving loop data. When a client connection is granted, the LOOP server sends the information requested by the user to child process number 3 via UNIX socket pipes. It then resets to wait for connection requests from other interested clients.
- Child Process Number 3: The third child process receives a client's information from child process number 2. After receiving the information, it also checks to see whether the client is asking for only a portion of the available data. For example, a client can specify a list of particular loops, all the available loops on a specific route (such as I-5), or all available loop data. When child process number 3 receives a data packet from process number 1, it assembles the correct data set requested by a client and transmits that data set via an Internet TCP socket. After completion, it resets and waits for data from either processes number 1 and number 2 or from clients.

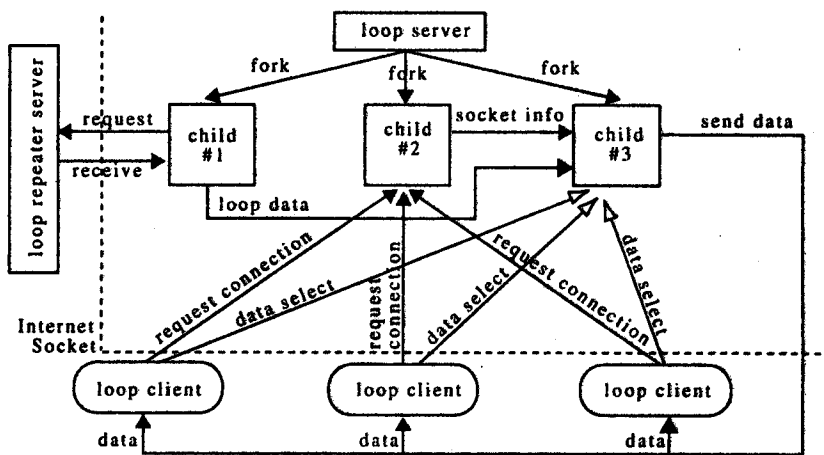

Figure 3.7: System architecture.

4. DATA FUSION: LOOP SPEED ESTIMATES

This chapter presents a robust algorithm for estimating mean traffic speed using single inductance loop measurements of volume (counts of vehicle over a duration) and occupancy (the fraction of some total duration during which the inductance loop senses the presence of a vehicle). Mechanisms to estimate speed from single loops has been of interest to traffic engineers for some time, as speed is not directly observable from single loop measurements (Hall and Persaud, 1988; Leutzbach 1988; Persaud and Hurdle, 1988; Hall and Gunter, 1986; Persaud and Hall, 1989; Hall, 1987; Dillon and Hall, 1987; Gunter and Hall, 1986; Dailey, 1993). Recent advanced traveler information system (ATIS) initiatives have created a need for a robust solution to this problem for a new class of applications, namely those that provide information to travelers. Such an initiative (Seattle Wide-Area Information for Travelers, SWIFT) creates the need to formulate the present algorithm.

This chapter acknowledges the statistical nature of the measurements taken with inductance loops and presents an algorithm to estimate speed that not only accounts for the statistical nature of the estimate but also provides a robustness test for the estimate. Four measurements are made by a traffic management system, Volume $N(t)$, Occupancy $O(t)$, speed $s(t)$, and vehicle length $l(t)$ (but only volume and occupancy are available from single loops). These measurements are by their nature realizations taken from the probability distributions of the underlying variables, at the time the measurement are made. Observations of these variables are typically combined to create estimates of speed; for example, several authors have used a ratio of volume (\hat{n}) and occupancy (\hat{o}) with correction (g) to estimate speed $\hat{s} = \hat{n}/g\hat{o}$ (Hall and Persaud, 1988; Leutzbach, 1988; Persaud and Hurdle, 1988; Wardrop, 1952; Kurkjian et al., 1980; Nahi, 1973; Payne et al., 1987). ATIS efforts typically require

estimates of speed and travel times but rely almost completely on the measurements made by traffic management systems, and as such they require the use of single inductance loop speed estimates.

Previous work has not explicitly included the statistics of the estimated quantities when estimating variables that are not observable. This work explicitly considers the statistics of estimates created by using observations from traffic management systems. The typical measurements are volume (N_i) and occupancy (O_i), and the relationship between volume, occupancy, speed s_{ij} , and length of the j th vehicle l_{ij} is,

$$O_i = \frac{1}{T} \sum_{j=1}^{N_i} \frac{l_{ij}}{s_{ij}}, \quad (4.1)$$

where T is the duration of the measurement. The speed and vehicle length are random variables with mean values and statistical distributions. We can express this by writing the speed and length observations as the expected value (mean) and some deviation ($\Delta l_{ij}, \Delta s_{ij}$) that occurs for this observation,

$$l_{ij} = \bar{l} + \Delta l_{ij} \quad (4.2)$$

$$s_{ij} = \bar{s} + \Delta s_{ij}. \quad (4.3)$$

Combining these terms in the form of the RHS of equation (4.1) we get,

$$\frac{l_{ij}}{s_{ij}} = \frac{\bar{l}}{\bar{s} + \Delta s_{ij}} + \frac{\Delta l_{ij}}{\bar{s} + \Delta s_{ij}}, \quad (4.4)$$

where the statistics of the deviation term are selected such that $E\{\Delta l_{ij}\} = E\{\Delta s_{ij}\} = 0$ and $E\{*\}$ is the expected value operator.

Each measurement produces a pair of volume (N_i) and occupancy (O_i) values. To use the statistics of these measurements, let E_i denote the conditional expectation over all realizations that have the volume N_i . Then the conditional expected value of equation (4.1) is

$$E_i\{O_i\} = \frac{N_i}{T} E_i\left\{\frac{l_{ij}}{s_{ij}}\right\}. \quad (4.5)$$

Inserting equation (4.4) in (4.5), we get

$$E_i \left\{ \frac{l_{ij}}{s_{ij}} \right\} = E_i \left\{ \frac{\bar{l}}{\bar{s} + \Delta s_{ij}} + \frac{\Delta l}{\bar{s} + \Delta s_{ij}} \right\}. \quad (4.6)$$

Rearranging the RHS, assuming that the variables $(\frac{1}{\Delta s_{ij}})$ and Δl_{ij} are independent and recognizing that $E\{\Delta l_{ij}\} = 0$, we get

$$E_i \left\{ \frac{l_{ij}}{s_{ij}} \right\} = E_i \left\{ \frac{\bar{l}}{\bar{s} + \Delta s_{ij}} \right\} = \frac{\bar{l}}{\bar{s}} E_i \left\{ \frac{1}{1 + \frac{\Delta s_{ij}}{\bar{s}}} \right\}. \quad (4.7)$$

Expand the RHS in a power series to obtain

$$E_i \left\{ \frac{l_{ij}}{s_{ij}} \right\} = \frac{\bar{l}}{\bar{s}} E_i \left\{ 1 - \frac{\Delta s_{ij}}{\bar{s}} + \frac{\Delta s_{ij}^2}{\bar{s}^2} - \frac{\Delta s_{ij}^3}{\bar{s}^3} + \dots \right\}. \quad (4.8)$$

Note that $E\{\Delta s_{ij}\} = 0$, approximating the power series with three terms, and inserting the result in equation (4.5), to obtain

$$E_i \{O_i\} = \frac{N_i \bar{l}}{T \bar{s}} \left[1 + \frac{E_i \{\Delta s_{ij}^2\}}{\bar{s}^2} \right]. \quad (4.9)$$

The variance of the speed estimate can be written, $\sigma_s^2 = E_i \{\Delta s_{ij}^2\}$. Substituting and rearranging, we get,

$$N_i = \frac{\bar{s}T}{\bar{l}} E_i \{O_i\} \left[\frac{\bar{s}^2}{\sigma_s^2 + \bar{s}^2} \right]. \quad (4.10)$$

The measurement of the occupancy is also a random variable with some mean and some deviation from that mean for the i th measurement. We can express this as,

$$O_i = \bar{O} - \Delta O_i; \quad \bar{O} = E_i \{O_i\}. \quad (4.11)$$

Substitute (4.11) into (4.10) to obtain

$$\frac{N_i}{O_i} = \frac{\bar{s}T}{\bar{l}} \left[\frac{\bar{s}^2}{\sigma_s^2 + \bar{s}^2} \right] - \frac{\Delta O_i \bar{s}T}{O_i \bar{l}} \left[\frac{\bar{s}^2}{\sigma_s^2 + \bar{s}^2} \right]. \quad (4.12)$$

This form has a deterministic component that contains only moments of the speed distribution and a stochastic component that contains ΔO_i . In the next section we consider the solution of the deterministic component.

4.1. DETERMINISTIC MEASUREMENTS

In the case where there are perfect measurements (e.g. $\Delta O_i = 0$), and each realization of volume and occupancy is equal to the mean of the probability distribution for that measurement,

$$\frac{N_i}{O_i} = \frac{\bar{s}T}{\bar{l}} \left[\frac{\bar{s}^2}{\sigma_s^2 + \bar{s}^2} \right]. \quad (4.13)$$

Previous authors have asserted a ratio of measured volumes and occupancies, converted to density by a constant, can be used to estimate speed (Hall and Persaud, 1988; Persaud and Hurdle, 1988; Hall and Gunter, 1986; Ross, 1988). However, rearranging equation (4.13) to the same form,

$$\frac{N_i}{O_i} \left(\frac{\bar{l}}{T} \right) = \bar{s} \left[\frac{\bar{s}^2}{\sigma_s^2 + \bar{s}^2} \right] \quad (4.14)$$

demonstrates that such an estimate is biased by the variability of the speed. An estimate based on perfect measurements can be obtained by solving

$$O_i \frac{T}{\bar{l}} \bar{s}^3 - N_i \bar{s}^2 - N_i \sigma_s^2 = 0 \quad (4.15)$$

for \bar{s} . Equation (4.15) has the form $f(s) = 0$ and can be solved for the real root.¹ This "root finding" solution provides an estimator for \bar{s} when there are idealized noiseless measurements; however, such is never the case. The next section provides an algorithm that addresses real measurements.

4.2. STOCHASTIC MEASUREMENTS

Measurements from a traffic management system are realizations from statistical distributions. To address the variability of the observations we present a filtering approach. The general form for the dynamics and observer equations for a Kalman filter are (Bozic, 1984)

$$X_{k+1} = g_k(X_k) + w_k \quad (4.16)$$

$$Z_k = h_k(X_k) + v_k. \quad (4.17)$$

¹The formula of DeMoivre allows for one real and two imaginary roots (Kreyszig, 1979).

For the k th time step we select our state variables to be the estimate of speed for the last two time steps. This autoregressive-like approach explicitly identifies a temporal correlation between speed estimates and recognizes that \bar{s} has some inherent variation in addition to the noise component. For our observables we use the ratio of the measurements for the two previous time steps. The selection of $\frac{O_k}{N_k}$ for our observable is based on the examining equation (4.1) and noting that the variable O_i is inversely proportional to the state variable \bar{s} . The number of observations (N_i) used to construct O_i is used to normalized the observed value of O_i to a per-vehicle basis. Further, when $N_i = 0$, the observation from that time step is undefined (as opposed to having zero value). We also note that in equation (4.12) there are deterministic and stochastic components, and we use the deterministic portion to construct the measurement function $h_k(\mathbf{X}_k)$, and we identify

$$\mathbf{X} = \begin{bmatrix} \bar{s}_k \\ \bar{s}_{k-2} \end{bmatrix}, \quad \mathbf{Z} = \begin{bmatrix} \frac{O_k}{N_k} \\ \frac{O_{k-1}}{N_{k-1}} \end{bmatrix}, \quad h_k(\mathbf{X}_k) = \frac{\bar{l}}{T} \begin{bmatrix} \frac{\sigma_s^2 + \bar{s}_k^2}{\bar{s}_k^3} \\ \frac{\sigma_s^2 + \bar{s}_{k-1}^2}{\bar{s}_{k-1}^3} \end{bmatrix} \quad (4.18)$$

where the measurement equation for $h_k(\mathbf{X}_k)$ is nonlinear in the state variables. The linear Kalman filter equations are written (Bozic, 1984)

$$\mathbf{X}_k = \mathbf{G}_k \mathbf{X}_{k-1} + \mathbf{w}_{k-1} \quad (4.19)$$

$$\mathbf{Z}_k = \mathbf{H}_k \mathbf{X}_k + \mathbf{v}_k \quad (4.20)$$

where the measurement equation is a linear function of the state variables. To use the linear filtering result, we adopt the extended Kalman filter approach, which linearizes the measurement equation from (4.17) about a point \mathbf{X}_k^p (for implementation we select this point to be the last \mathbf{X}_k)

$$h_k(\mathbf{X}_k) = h_k(\mathbf{X}_k^p) + dh(\mathbf{X}_k^p)(\mathbf{X}_k - \mathbf{X}_k^p) \quad (4.21)$$

and create a new measurement equation,

$$\hat{\mathbf{Z}}_k = \hat{\mathbf{H}}_k \mathbf{X}_k + \mathbf{v}_k \quad (4.22)$$

where,

$$\hat{\mathbf{Z}}_k = \{\mathbf{Z}_k - h_k(\mathbf{X}_k^p) + dh(\mathbf{X}_k^p)\mathbf{X}_k^p\} \quad \hat{\mathbf{H}}_k = dh(\mathbf{X}_k^p) \quad (4.23)$$

and,

$$dh_k(\mathbf{X}_k) = \begin{bmatrix} -\frac{3\bar{l}}{T} \left[\frac{\bar{s}_{k-1}^2 + \sigma_s^2}{\bar{s}_{k-1}^4} \right] & 0 \\ 0 & -\frac{3\bar{l}}{T} \left[\frac{\bar{s}_{k-2}^2 + \sigma_s^2}{\bar{s}_{k-2}^4} \right] \end{bmatrix}. \quad (4.24)$$

Our state-transition matrix, \mathbf{G} , provides weights for the contribution of \bar{s} from the previous two time steps,

$$\mathbf{G}_k = \begin{bmatrix} a & b \\ 1 & 0 \end{bmatrix} \quad (4.25)$$

where a and b are selected using forward/backward least squares estimates of the AR(2) coefficients for the experimentally measured speed. The noise contributions are

$$\mathbf{Q}_k = E\{\mathbf{w}_k\mathbf{w}_k^T\} \quad \mathbf{R}_k = E\{\mathbf{v}_k\mathbf{v}_k^T\} \quad (4.26)$$

where,

$$\mathbf{Q} = \begin{bmatrix} \sigma_s^2 & 0 \\ 0 & \sigma_s^2 \end{bmatrix} \quad \mathbf{R} = \begin{bmatrix} \sigma_{\frac{Q}{N}}^2 & 0 \\ 0 & \sigma_{\frac{Q}{N}}^2 \end{bmatrix} \quad (4.27)$$

and values for the variances $\sigma_{\frac{Q}{N}}^2$ and σ_s^2 are obtained experimentally. With these definitions we can use the linear filter solution,

$$\mathbf{P}_k^1 = \mathbf{G}\mathbf{P}_{k-1}\mathbf{G}^T + \mathbf{Q}_{k-1} \quad (4.28)$$

$$\mathbf{K}_k = \mathbf{P}_k^1 \hat{\mathbf{H}}_k^T \left[\hat{\mathbf{H}}_k \mathbf{P}_k^1 \hat{\mathbf{H}}_k^T + \mathbf{R}_k \right]^{-1} \quad (4.29)$$

$$\mathbf{P}_k = \mathbf{P}_k^1 - \mathbf{K}_k \hat{\mathbf{H}}_k \mathbf{P}_k^1 \quad (4.30)$$

$$\mathbf{X}_k = \mathbf{G}\mathbf{X}_{k-1} + \mathbf{K}_k \left[\hat{\mathbf{Z}}_k - \hat{\mathbf{H}}_k \mathbf{G}\mathbf{X}_{k-1} \right] \quad (4.31)$$

from Bozic (1984) to update the state variables at each time step. This provides an algorithm to create a maximum likelihood estimate of the speed using the observed volumes and occupancies. The confidence we place in this estimate can be tested by calculating the mean car length for each estimate using

$$\bar{l}_i = \frac{O_i T}{N_i} \left[\frac{\bar{s}_k^3}{\sigma_s^2 + \bar{s}_k^2} \right] \quad (4.32)$$

and comparing this estimate with long time estimates of the mean (\bar{l}) and standard deviation (σ_l) of the length distribution. If $(\bar{l} - c) < \bar{l}_k < (\bar{l} + d)$ (where c and d are selected based on the statistics of \bar{l}), the speed estimate is deemed to be acceptable.

4.3. EMPIRICAL RESULTS

In this section presents empirical results for the two estimators presented and compares these results with empirical speed trap measurements. The two new estimators presented here are (1) the “root finding” method based on the assumptions of deterministic values and (2) the filtering method.

Measurements of traffic on Interstate 5 in Seattle were taken from the WSDOT Traffic Management System (TMS). The sites selected for testing have pairs of loops that both act as speed traps and measure volume and occupancy. The loop detector stations average (sum) the values for volume and occupancy over a 20-second interval, and all the data presented here are for 20-second averages.

In the algorithms presented here, a mean value for length, \bar{l} , is necessary, as is an estimate of the variability of the speed, σ_s . To obtain a mean length for the calculation, we used the empirical length estimates from the TMS over a six-day period. The histogram of the observed lengths is shown in Figure 4.1, and the mean value used to seed the calculation is 25.63 feet. This empirically generated distribution of lengths is also useful for testing the robustness of the filter estimate. This test is described later in this chapter.

The first empirical result presented here is the speed estimate from the roots of equation (4.15). These speed estimates are unbiased point estimates of the speed, given σ_s and \bar{l} . A comparison of the root speed estimate and the speed measurement from the speed trap is shown in the center plot of figures 4.2 and 4.3. The estimate has a larger variance than the measured data but generally follows the character of the measured speed. The mean of the deviation of the estimates of speed from the observed 20-second average speed (e.g. $\mu_e = E\{(s - \hat{s}_e)\}$) indicate of the bias in the estimator. More conventional estimates using a “g” factor (taken from the TMS) shown in the bottom plot in figures 4.2 and 4.3, have a bias relative to the

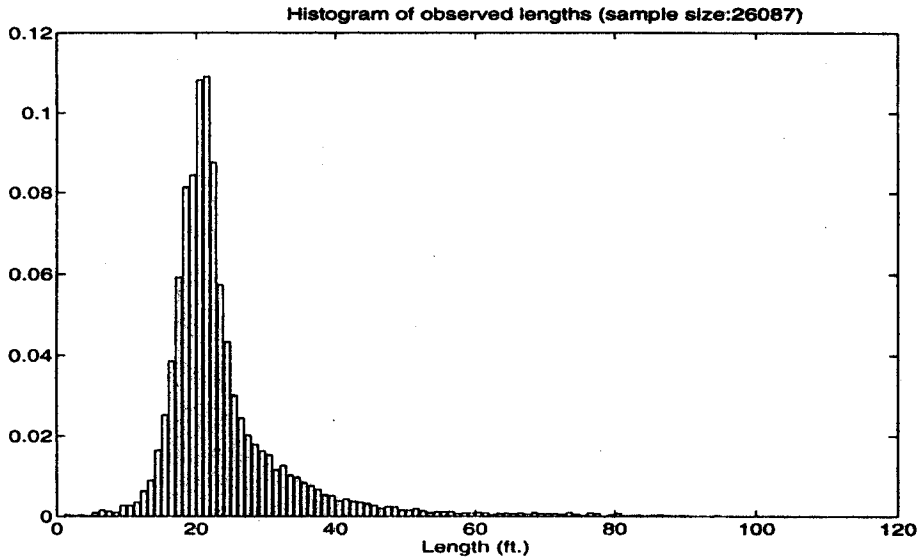

Figure 4.1: Histogram of effective vehicle length.

measurements ($\mu_g = 3.1$). The root methodology estimate has little bias relative to the measurements ($\mu_r = 0.07$).

The second speed estimator, the Kalman filter approach, is derived from equations (4.28) through (4.31). The estimate is plotted (see the top plots in figures 4.2 and 4.3) with the empirical speed from the speed trap associated with the loop detector from which we obtain the volume and occupancy. In this case, the estimate reflects the variability in the speed as a function of time with a smaller variance than the measured speed.

It is important to note that the speed trap realization is a point estimate of the traffic conditions and is not the mean value of the speed distribution for the traffic conditions as they exist. The robustness of the estimate of speed can be addressed using knowledge of the statistics for mean length as embodied in Figure 4.1 and a calculation of \bar{l}_i from equation (4.32). Speed estimates that produce \bar{l}_i values that are sufficiently far from the probability mass of the distribution are less reliable than those that produce values near the most probable lengths. The empirical distribution of length is an asymmetric, strongly peaked distribution containing 95 percent of the

probability mass in the range of 15 to 40 feet and with small probability of occurrence (less than 0.008) outside this range. The selection of the criteria for accepting the validity of a speed estimate is an engineering judgment based on the probability of occurrence. We define robust estimates of speed to be those estimates that produce a length estimate (for a 20-second average length) in the range of 15 to 40 feet, and those outside this range are deemed unreliable. This criterion provides an independent means to evaluate the reliability of our speed estimates. Figure 4.4 presents the mean lengths produced by using the filter estimates for speed. For comparison, Figure 4.5 presents the lengths as measured by the TMS. It is clear that in some cases the estimate made by the filter violates the robustness criteria and would not be used for subsequent modeling calculations and traveler information systems.

4.4. SPEED ESTIMATES CONCLUSIONS AND RECOMMENDATIONS

This chapter presents an algorithm to estimate speed from single inductance loops, as well as providing an acceptability test for the estimates. The algorithm specifically acknowledges the statistics of the problem, and the acceptability test uses the statistics of one of the observables to set criteria for evaluating the reliability of the estimate. The algorithm is presented as a Kalman filter using a second-order system equation equivalent to an AR(2) model. The Kalman filter equations have an equivalent algebraic form (obtained by performing the matrix operations analytically) which reduces the computational complexity and makes the algorithm appropriate for use with single inductance loop data in both traffic management systems and traveler information systems.

Recommendations for use of the algorithmic material presented include:

1. The Kalman filter result can be implemented as a series of algebraic equations by solving the linear algebra in equations (4.28) through (4.31) making it tractable for use in ATMS and ATIS applications.
2. The algebraic implementation of the filter solution can be implemented as C or C++ language modules and can then be supplied as a template for future

ATIS/ATMS activities.

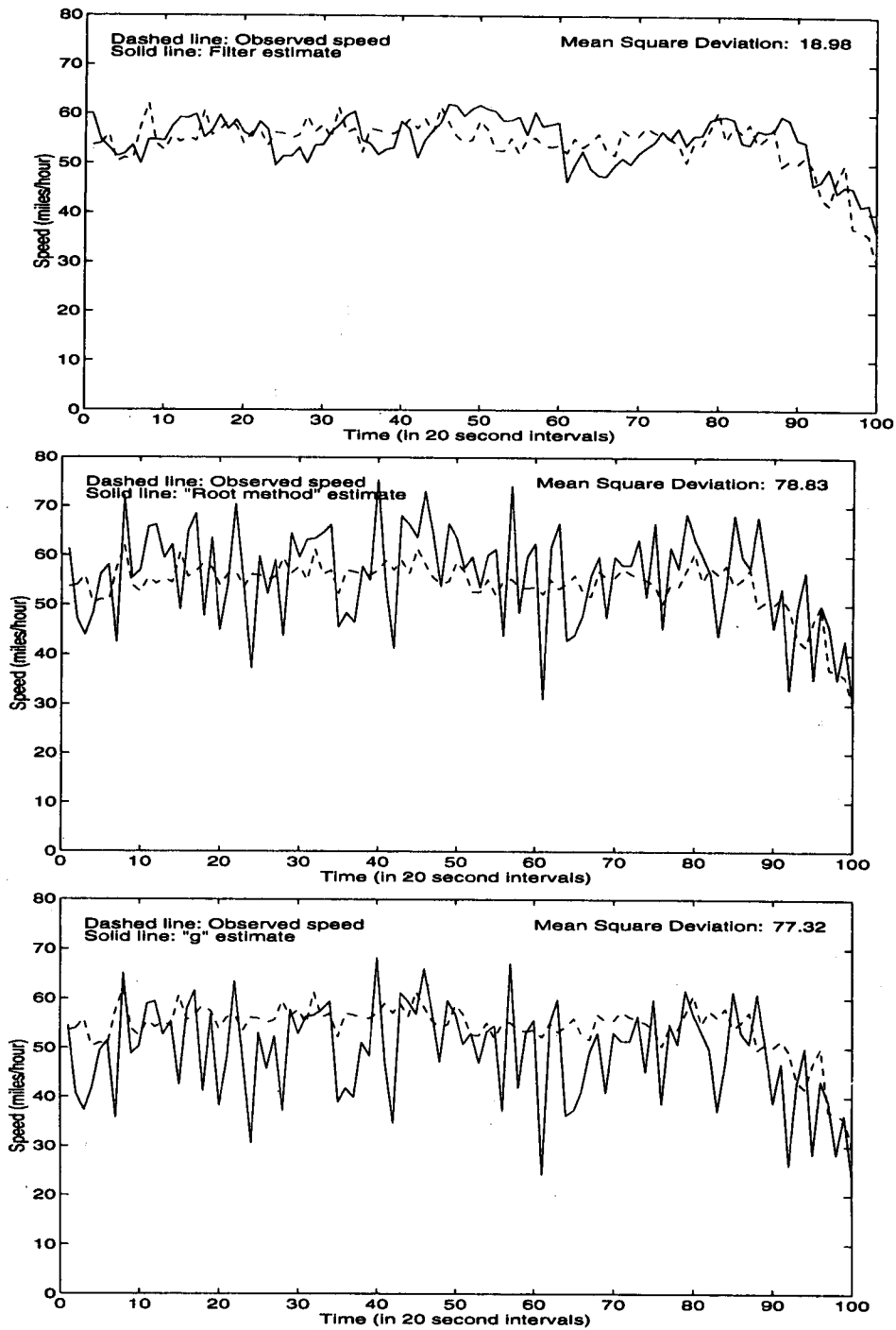

Figure 4.2: Speed estimates at free flow.

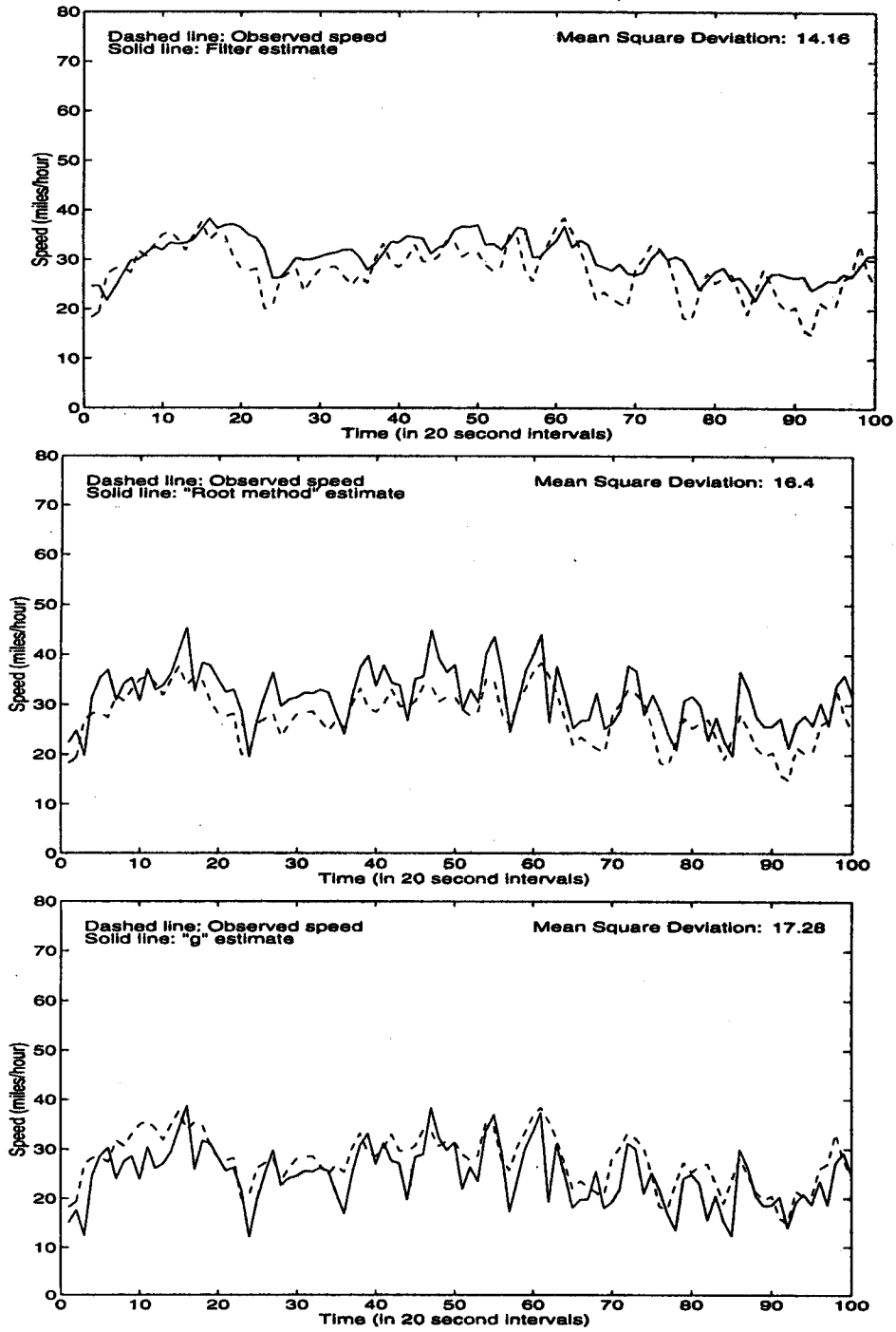

Figure 4.3: Speed estimates for low speeds.

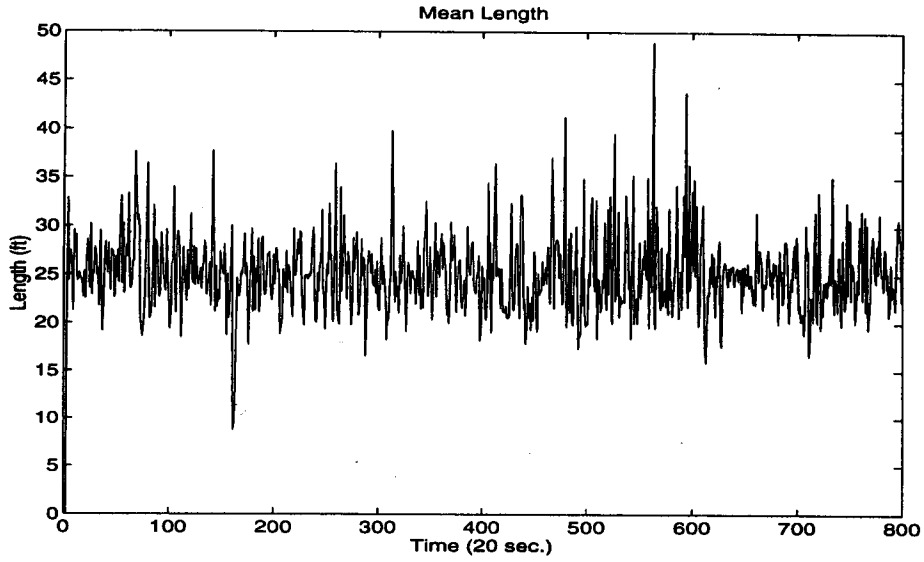

Figure 4.4: Effective vehicle length estimates as a function of time.

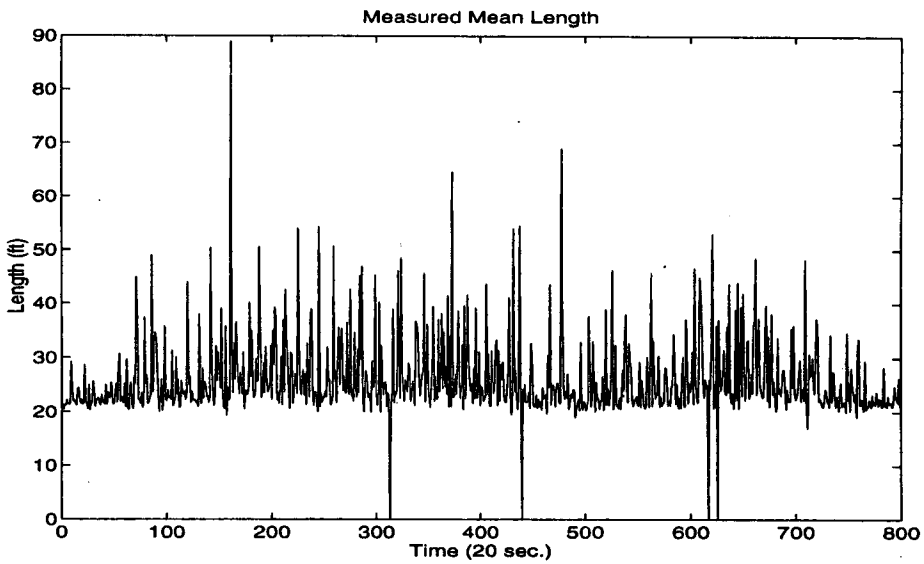

Figure 4.5: Effective vehicle length as measured by the TMS.

5. CONCLUSIONS

This project accomplished three significant tasks. First, a state-of-the-art literature review provided an organizational framework for categorizing the various data fusion projects that have been conducted to date. A popular typology was discussed to situate data fusion technologies into one of three levels, depending on the degree to which sensor data are correlated to provide users with meaningful transit recommendations. The trade-offs that accompany higher-level data fusion efforts - in terms of computing power and memory requirements - were noted. The advantages of multiple-sensor data fusion projects in terms of cost, accuracy, and reliability were also discussed, and contrasts were drawn with the traditional deployment of highly accurate, single sensors. Specific techniques of data fusion were described and their possible application to ITS projects was explored. In fact, this report is one of the first to consider how data fusion technology might be productively applied to the needs of transportation management.

A second major component of this report is the description of a local data fusion application. This project employs data fusion techniques to correlate input from multiple highway sensors and generate reliable traffic predictions. The resulting information can be displayed for use by commuters as they choose from among various transit options. The architecture of this data fusion system is described in detail.

The third component of the project was to create a statistically based algorithm to estimate speed from volume and occupancy measurements. The algorithm presented explicitly accounts for the statistics of the problem and provides a robustness test for the speed estimate.

6. REFERENCES

Bahowick, T.J. "The Kalman Filter." An oral report given at the University of Washington, 1990. Adapted from Bozic, S.M. *Digital and Kalman Filtering: An Introduction to Discrete Time-Filtering and Optimum Linear Estimation*. Edward Arnold Publishers: London, 1979.

Bar-Shalom, Y. and T.E. Fortmann. *Tracking and Data Association*. Academic Press: New York, 1987.

Bavarian, B. "Neural Networks." *The Electrical Engineering Handbook*. Ed. by R.C. Dorf. CRC Press: Boca Raton, FL, 1993.

Behringer, R., Holt, V., and D. Dickmanns. "Road and Relative Ego-state Recognition." *Proceedings of the Intelligent Vehicles '92 Symposium*. 29 June-1 July 1992: Detroit, MI. IEEE, 1990 (385-90).

Belcastro, C.M., Fischl, R., and M. Kam. "Fusion Techniques Using Distributed Kalman Filtering for Detecting Changes in Systems." *Proceedings of the 1991 American Control Conference*. 26-28 June 1991: Boston, MA. American Autom. Control Council, 1991. Vol. 3: (2296-2298).

Blackman, S.S. and T.J. Broida. "Multiple Sensor Data Association and Fusion in Aerospace Applications." *Journal of Robotic Systems*. June 1990: (445-85).

Booth, D.M., Thacker, N.A., Mayhew, J.E.W., and M.K. Pidcock. "Combining the Opinions of Several Early Vision Modules Using a Multi-layer Perceptron." *International Journal of Neural Networks - Research & Applications*. June-Dec. 1991: (75-80).

Boyce, D.E., Kirson, A., and J.L. Schofer. "Design and Implementation of ADVANCE: the Illinois Dynamic Navigation and Route Guidance Demonstration Program." *VNIS '91. Vehicle Navigation and Information Systems Conference Proceedings*. 20-23 Oct. 1991: Dearborn, MI. Soc. Automotive Eng., 1991. Vol 1: (415-26).

Bozic, S.M. *Digital and Kalman Filtering: An Introduction to Discrete Time Filtering and Optimum Linear Estimation*. Edward Arnold Publishers: London, 1979.

Bozic, S.M. *Digital and Kalman Filtering*. Edward Arnold Publishers: London, 1984.

Broatch, S.A. and A.J. Henley. "An Integrated Navigation System Manager Using Federated Kalman Filtering." *Proceedings of the IEEE 1991 National Aerospace and Electronics Conference NAECON 1991*. 20-24 May 1991: Dayton, OH. IEEE, 1991. Vol. 1: (422-426).

Brogi, A., Filippi, R., Gaspari, M., and F. Turini. "An Expert System for Data Fusion Based on a Blackboard Architecture." *Expert Systems and Their Applications - Specialized Conference. Artificial Intelligence and Defense, Expert Systems and Maintenance, Expert Systems and Medicine*. 30 May-3 June 1988: Avignon, France (147-65).

Buede, D.M. and E.L. Waltz. "Benefits of Soft Sensors and Probabilistic Fusion." *Signal and Data Processing of Small Targets 1989. Proceedings of the SPIE - The International Society for Optical Engineering*. 27-29 March 1989: Orlando, FL. SPIE, 1989 (309-20).

Butini, F., Cappellini, V., and S. Fini. "Remote Sensing Data Fusion on Intelligent Terminals." *European Transactions on Telecommunications and Related Technologies*. Nov.-Dec. 1992: (555-63).

Cameron, A. and H.L. Wu. "Identifying and Localizing Electrical Components: A Case Study of Adaptive Goal-directed Sensing." *Proceedings of the 1991 IEEE International Symposium on Intelligent Control*. 13-15 Aug. 1991: Arlington, VA.

IEEE, 1991 (495-500).

Capocaccia, G., Damasio, A., Regazzoni, D.S., and G. Vernazza. "Data Fusion Approach to Obstacle Detection and Identification." *Proceedings of the SPIE - The International Society for Optical Engineering*. 7-9 Nov. 1988: Cambridge, MA. SPIE, 1988. Vol. 1003: (409-19).

Case, E.R., Van Aerde, M, and M. Krage. "Supporting Routines for Modelling the Traffic Responsive Features of the TravTek System using INTEGRATION." *VNIS '91. Vehicle Navigation and Information Systems Conference Proceedings*. 20-23 Oct. 1991: Dearborn, MI. Vol. 2: (681-91).

Chang, E.C.P. "A Neural Network Approach to Freeway Incident Detection." *VNIS '92. The Third International Conference on Vehicle Navigation & Information Systems*. IEEE, 1992 (641-47).

Chao, J.J. "Knowledge-based Moving Target Detector." *ISNCR-89. Noise and Clutter Rejection in Radars and Imaging Sensors. Proceedings of the Second International Symposium*. 14-16 Nov. 1989: Kyoto, Japan. Inst. Electron. Inf. Commun., 1990 (520-525).

Chao, J.J., Cheng, C.M., and C.C. Su. "A Moving Target Detector Based on Information Fusion." *Record of the IEEE 1990 International Radar Conference*. 7-10 May 1990: Arlington, VA. IEEE, 1990 (341-4).

Collins, J.B. and J.K. Uhlmann. "Efficient Gating in Data Association with Multivariate Gaussian Distributed States." *IEEE Transactions on Aerospace and Electronic Systems*. July 1992: (909-16).

Dailey, D.J. "Travel Time Estimation Using Cross Correlation Techniques." *Transportation Research B*. 1993: Vol 27B(2): (97-107).

DeClaris, N. "Neural Network." *McGraw-Hill Encyclopedia of Science & Technology*. McGraw-Hill: New York, 1992.

Dillon, D.S. and F.L. Hall. "Freeway Operations and the Cusp Catastrophe: An Empirical Analysis." *Transportation Research Record*. 1987: Vol. 1132: (66-76).

Durrant-Whyte, H.F., Rao, B.Y.S., and H. Hu. "Toward a Fully Decentralized Architecture for Multi-sensor Data Fusion." *Proceedings 1990 IEEE International Conference on Robotics and Automation*. 13-18 May 1990: Los Alamitos, CA. IEEE Comput. Soc. Press, 1990. Vol. 2: (1331-1336).

Easthope, P.F., Goodchild, E.J.G., and S.L. Rhodes. "A Computationally Tractable Approach to Real-time Multi-sensor Data Fusion." *Proceedings of the SPIE - The International Society for Optical Engineering*. 27-29 March 1989: Orlando, FL. SPIE, 1989. Vol. 1096: (298-308).

Fennelly, A.J., Woosley, J.K., McMahon, D.M., Bhuminder, S., and J.W. Wolfsberger. "Multivariate Data Spaces and Multivariable Systems Analysis for Explosive Detection Systems Using X-rays." *Proceedings of the SPIE - The International Society for Optical Engineering*. 23-24 July 1992: San Diego, CA. SPIE, 1992. Vol. 1736: (159-70).

Fincher, D.W. and D.F. Mix. "Multi-sensor Data Fusion Using Neural Networks." *1990 IEEE International Conference on Systems, Man, and Cybernetics*. 4-7 Nov. 1990: Los Angeles, CA. IEEE, 1990 (835-8).

Gunter, M.A. and F.L. Hall. "Transitions in the Speed-Flow Relationship." *Transportation Research Record*. 1986: Vol. 1091: (18-21).

Gupta, M.M. "Fuzzy Sets and Systems." *McGraw-Hill Encyclopedia of Science & Technology*. McGraw-Hill: New York, 1992.

Hackett, J.K. and M. Shah. "Multi-sensor Fusion: A Perspective." *Proceedings 1990 IEEE International Conference on Robotics and Automation*. 13-18 May 1990: Cincinnati, OH. IEEE, 1990. Vol. 2: (1324-30)

Haimovich, A.M., Yosko, J., Greenberg, R.J., Parisi, M.A., and D. Becker. "Fusion of Sensors with Dissimilar Measurement/Tracking Accuracies." *IEEE Transac-*

tions on Aerospace and Electronic Systems. Jan. 1993: (245-9).

Hall, F.L. "An Interpretation of Speed-Flow-Concentration Relationships Using Catastrophe Theory." *Transportation Research A*. 1987: Vol. 21: (191-201).

Hall, F.L. and M.A. Gunter. "Further Analysis of the Flow-Concentration Relationship." *Transportation Research Record*. 1986: Vol. 1091: (1-9).

Hall, F.L. and B.N. Persaud. "Estimating Speeds from Freeway Traffic Management Systems." *ITE 1988 compendium of Technical Papers*. 1988: (166-171)

Harris, C.J. "Distributed Estimation, Inferencing and Multi-sensor Data Fusion for Real Time Supervisory Control." *Artificial Intelligence in Real-Time Control 1989. Proceedings of the IFAC Workshop*. 19-21 Sept. 1989: Shenyang, China (19-24).

Harris, C.J., and A.B. Read. "Knowledge-based Fuzzy Motion Control of Autonomous Vehicles." *Artificial Intelligence in Real-Time Control. Proceedings of the IFAC Workshop*. 21-23 Sept. 1988: Swansea, UK (139-44).

Hayes-Roth, F. "Expert Systems." *McGraw-Hill Encyclopedia of Science & Technology*. McGraw-Hill: New York, 1992.

Hazlett, T.L., Cofer, R.H., and H.K. Brown. "Explanation Mode for Bayesian Automatic Object Recognition." *Automatic Object Recognition II. Proceedings of the SPIE - The International Society for Optical Engineering*. 22-24 April 1992: Orlando, FL. SPIE, 1992 (258-268).

Hoballah, I.Y. and P.K. Varshney. "Distributed Bayesian Signal Detection." *IEEE Transactions on Information Theory*. Sept. 1989: (995-1000).

Hughes, T.J. "Sensor Fusion in a Military Avionics Environment." *Measurement and Control*. Sept. 1989: (203-205).

Kalman, R.E. "A New Approach to Linear Filtering and Prediction Problems." *Trans. ASME, J. of Basic Engineering*. March 1960: (35-45).

Kessaci, A., Farges, J.L., and J.J. Henry. "On Line Estimation of Turning Movements and Saturation Flows in PRODYN." *Control, Computers, Communications in Transportation. Papers from the IFAC/IFIP/IFORS Symposium.* 19-21 Sept. 1989: Paris, France. IFAC. 1990 (191-7).

Kim, K. "Bayesian Inference Network: Applications to Target Tracking." *Proceedings of the SPIE - The International Society for Optical Engineering.* 20-22 April 1992: Orlando, FL. SPIE, Vol. 1698: (360-71).

Kirson, A., Smith, B.C., Boyce, D., and J. Shofer. "The Evolution of ADVANCE." *VNIS '92. The Third International Conference on Vehicle Navigation & Information Systems.* IEEE, 1992 (516-23).

Kraiss, K.F., and H. Kuttelwesch. "Identification and Application of Neural Operator Models in a Car Driving Situation." *IJCNN '91 Seattle: International Joint Conference on Neural Networks.* 8-14 July 1991: Seattle, WA. Vol. 2: (917).

Kreyszig, E. *Advanced Engineering Mathematics.* John Wiley & Sons, fourth edition, 1979.

Kurkjian, Andrew; Gershwin, Stanley B.; Houpt, Paul K.; Willsky, Alan S.; and E.Y. Chow. "Estimation of Roadway Traffic Density on Freeways Using Presence Detector Data." *Transportation Science.* August 1980: Vol. 14(3): (232-361).

Leardi, C., Murino, V., and C.S. Regazzoni. "Scene Interpretation by Perceptual Goals Integration." *Proceedings of the IASTED International Symposium Artificial Intelligence Application and Neural Networks - AINN '90.* 25-27 June 1990: Zurich, Switzerland (133-6).

Lee, R.H. and R. Leahy. "Segmentation of Multi-sensor Images." *Sixth Multidimensional Signal Processing Workshop.* 6-8 Sept. 1989: Pacific Grove, CA. IEEE, 1989, (23).

Leung, D.S.P. and D.S. Williams. "A Multiple Hypothesis Based Multiple Sensor Spatial Data Fusion Algorithm." *Automatic Object Recognition. Proceedings of the*

SPIE - The International Society for Optical Engineering. 3-5 April 1991: Orlando, FL. SPIE, 1991. Vol. 1471: (314-325).

Leutzbach, W. *Introduction to the Theory of Traffic Flow*. Springer-Verlag, 1988.

Liebowitz, J. *Introduction to Expert Systems*. Mitchell/McGraw-Hill: New York, 1988.

Liebowitz, J. "Rule-based Expert Systems." *The Electrical Engineering Handbook*. Ed. by R.C. Dorf. CRC Press: Boca Raton, FL, 1993.

Lin, C.F., Yang, C., Cloutier, J, Evers, J.H., and R. Zachery. "Fusion of Hybrid Data in Mode Estimation." *Proceedings of the 30th IEEE Conference on Decision and Control*. 11-13 Dec. 1991: Brighton, UK. IEEE, 1991. Vol. 3: (3072-81).

Linn, R.J. and D.L. Hall. "A Survey of Multi-sensor Data Fusion Systems." *Proceedings of the SPIE - The International Society for Optical Engineering*. 1-2 April 1991: Orlando, FL. SPIE, 1991. Vol. 1470: (13-29).

Liu, L.J., Gu, Y.G., and J.Y. Yang. "Inference for Data Fusion." *Neural and Stochastic Methods in Image and Signal Processing. Proceedings of the SPIE - The International Society for Optical Engineering*. 20-23 July 1992: San Diego, CA. SPIE, 1992 (670-677).

Llinas, J. and R.T. Antony. "Blackboard Concepts for Data Fusion Applications." *International Journal of Pattern Recognition and Artificial Intelligence*. April 1993 (285-308).

Lure, Y.M.F., Grody, N.C., Chiou, Y.S.P., and H.Y.M. Yeh. "Data Fusion with Artificial Neural Networks for Classification of Earth Surface from Microwave Satellite Measurements." *Telematics and Informatics*. Summer 1993: (199-208).

Maitre, B. and H. Laasri. "Cooperating Expert Problem-solving in Blackboard Systems: ATOME Case Study." *Decentralized A.I. Proceedings of the First European Workshop on Modelling Autonomous Agents in a Multi-Agent World*. 16-18 Aug.

1989: Cambridge, UK. North-Holland: Amsterdam, Netherlands, 1990 (251-63).

Mammano, F.J. and R. Sumner. "Pathfinder Status and Implementation Experience." *VNIS '91. Vehicle Navigation and Information Systems Conference Proceedings*. 20-23 Oct. 1991: Dearborn, MI. Vol. 1: (407-13).

Mammano, F. and R. Sumner. "Pathfinder System Design." *VNIS '89. Conference of the First Vehicle Navigation & Information Systems*. 11-13 Sept. 1989: Toronto, Canada (484-8).

Martinez, D., Esteve, D., and H. Demmou. "Evaluation of a Modular Multilayer Architecture for Recognizing Dangerous Situations in Car Driving." *Neuro-Nimes '90. Third International Workshop*. 12-16 Nov. 1990: Nimes, France (71-80).

Moutarlier, P. and R. Chatila. "Stochastic Multisensory Data Fusion for Mobile Robot Location and Environment Modelling." *Robotics Research: Fifth International Symposium*. 28-31 Aug. 1989: Tokyo, Japan. MIT Press, 1990 (85-94).

Nahi, Nasser E. "Freeway-traffic Data Processing." *Proceedings of the IEEE*. May 1973: Vol. 61(5): (537-541).

Niehaus, A. and R.F. Stengel. "Probability-based Decision Making for Automated Highway Driving." *VNIS '91. Vehicle Navigation & Information Systems Conference Proceedings*. 20-23 Oct. 1991: Dearborn, MI. Soc. Automotive Eng.: Warrendale, PA, 1991. Vol. 2: (1125-36).

Nijhuis, J., Hofflinger, B., Neussber, S., and A. Siggelkow. "A VLSI Implementation of a Neural Car Collision Avoidance Controller." *IJCNN '91 Seattle: International Joint Conference on Neural Networks*. 8-14 July 1991: Seattle, WA. Vol 1: (493-9).

Payne, Harold J.; Brown, David; and Stephen L. Cohen. "Improved Techniques for Freeway Surveillance." *Transportation Research Record 1112. Highway Capacity and Flow Theory and Characteristics*. 1987: Vol. 1112: (52-60).

Payne, T. "Central Fusion of Sensor Information Using Reasoned Feedback." *Complex Systems: From Biology to Computation*. IOS Press: Amsterdam, Netherlands, 1993 (248-59).

Persaud, B.N. and F.L. Hall. "Catastrophe Theory and Patterns in 30-Second Freeway Traffic Data - Implications for Incident Detection." *Transportation Research A*. 1989: Vol. 23: (103-113).

Persaud, B.N. and V.F. Hurdle. "Some New Data that Challenge Some Old Ideas about Speed-Flow Relationships." *Transportation Research Record*. 1988: Vol. 1194: (191-198).

Puente, E.A., Moreno, L., Salichs, M.A., and D. Gachet. "Analysis of Data Fusion Methods in Certainty Grids: Application to Collision Danger Monitoring." *Proceedings IECON '91. 1991 International Conference on Industrial Electronics, Control and Instrumentation*. 28 Oct.-1 Nov. 1991: Kobe, Japan. IEEE, 1991. Vol. 2: (1133-7).

Rillings, J.H. and J.W. Lewis. "TravTek." *VNIS '91. Vehicle Navigation and Information Systems Conference Proceedings*. 20-23 Oct. 1991: Dearborn, MI. Vol. 2: (729-37).

Ross, P. "Some Properties of Macroscopic Traffic Models." *Transportation Research Record*. 1988: Vol. 1194: (129-134).

Sarma, V.S. and S. Raju. "Multisensor Data Fusion and Decision Support for Airborne Target Identification." *IEEE Transactions on Systems, Man and Cybernetics*. Sept.-Oct. 1991: (1224-30).

Schlachta, H.B. and Studenny, J. "Interoperability Versus Integration of Omega and GPS." *Journal of Navigation*, May 1990 (229-237).

Shuman, V. *Primer on Intelligent Vehicle Highway Systems*. Transportation Research Board: Washington, D.C. August, 1993.

Sikka, D.I., Varshney, P.K., and V.C. Vannicola. "A Distributed Artificial Intelligence Approach to Object Identification and Classification." *Proceedings of the SPIE - The International Society for Optical Engineering*. 28-29 March 1989: Orlando, FL (73-84).

Stamenkovich, M. "An Application of Artificial Neural Networks for Autonomous Ship Navigation Through a Channel." *VNIS '91. Vehicle Navigation and Information Systems Conference Proceedings*. 20-23 Oct. 1991: Dearborn, MI. Vol. 1: (475-81).

Sumner, R. "Data Fusion in Pathfinder and TravTek." *VNIS '91. Vehicle Navigation and Information Systems Conference Proceedings*. 20-23 Oct. 1991: Dearborn, MI. Soc. Automotive Eng.: Warrendale, PA, 1991. Vol. 1: (71-5).

Wardrop, J.G. "Some Theoretical Aspects of Road Traffic Research." *Proceedings of the Institution of Civil Engineers*. 1952: Vol. 3: (158).

Wen, W. and H.F. Durrant-Whyte. "Model-based Multi-sensor Data Fusion." *Proceedings. 1992 IEEE International Conference on Robotics and Automation*. 12-14 May 1992: Nice, France. IEEE: Los Alamitos, CA, 1992. Vol. 2: (1720-6).

Zhu, Q., Huang, Y., and M. Payne. "An Expanded Dempster-Shafer Reasoning Technique for Image Feature Integration and Object Recognition." *Neural and Stochastic Methods in Image and Signal Processing. Proceedings of the SPIE - The International Society for Optical Engineering*. 20-23 July 1992: San Diego, CA. SPIE, 1992 (36-47).

Zhu, Q. and E.S. Lee. "Dempster-Shafer Approach in Propositional Logic." *International Journal of Intelligent Systems*. March 1993 (341-9).

A. GLOSSARY WITH ACRONYMS

Adaptive (or artificial) neural networks (ANN): See Neural networks.

ADVANCE (Advanced Driver and Vehicle Advisory Navigation Concept): A Chicago-area demonstration of ATIS and ATMS (see below) sponsored by the FHWA and the Illinois DOT. The objective is to evaluate the performance of a large-scale dynamic route guidance system. The program seeks to relieve traffic congestion by using alternative approaches for driver information systems; dynamic traffic information acquisition; and incident detection, analysis and forecasting. Operation in the northwest suburbs of Chicago began in early 1994.

Advanced Traffic Management Systems (ATMS): An array of institutional, human, hardware, and software components designed to monitor, control, and manage traffic on streets and highways.

Advanced Traveler Information Systems (ATIS): ITS technologies that assist travelers with planning, perception, analysis, and decision-making.

AGV: See Autonomous guided vehicles.

AI: See Artificial Intelligence.

Artificial intelligence (AI): The subfield of computer science concerned with understanding the nature of intelligent action and constructing computer systems capable of such action. It embodies the dual motives of furthering basic scientific understanding and making computers more sophisticated in the service of mankind.

ATIS: See Advanced Traveler Information Systems.

ATMS: See Advanced Traffic Management Systems.

Autonomous guided vehicles (AGV): Fully autonomous vehicles that utilize on-board intelligent sensors to determine the state of the vehicle itself and the outside world.

Bayesian decision theory: The process of selecting an action with the greatest expected value of utility given a probabilistic model describing an uncertain state. It is based upon Bayes' Theorem, a centuries-old formula used to determine conditional probabilities given *a priori* (i.e., prior) evidence. These revised probabilities are called *a posteriori* probabilities.

Blackboard architecture: A specialized type of expert system that contains a system component called a blackboard. A blackboard is a global database that can manage multiple cooperating sources of knowledge. Many in the AI community regard blackboard systems as the most promising scheme for the next generation of

knowledge-based systems. (See also Expert systems.)

Cluster analysis: A general approach to multivariate problems whose aim is to detect whether individual items fall into groups or clusters.

Data association: A general method of level one fusion in which one set of sensor data is correlated with another set of sensor data. For instance, new traffic information can be compared against historical traffic patterns to determine whether an unusual event is taking place.

Data fusion: Has to do with the combination of complementary and sometimes competing sensor data into a reliable estimate of the environment to achieve a "whole that is greater than the sum of its parts."

Dempster-Shafer evidential reasoning (DSER): A generalization of Bayes reasoning that offers a way to combine uncertain information from disparate sensor sources by setting up confidence intervals of certainty to replace single-point probabilities.

DOT: Department of Transportation. Responsible for ITS implementations.

DRIVE (Dedicated Road Infrastructure for Vehicle Safety in Europe): A European ITS project that uses an expert system to decompose driving tasks into subtasks and a neural network to allocate these subtasks to individual processing elements.

DSER: See Dempster-Shafer evidential reasoning.

Expert systems (or knowledge-based expert systems): A computer program that emulates a human expert in a well-bounded domain of knowledge. Typically, an expert system has three major components: the dialog structure, the inference engine, and the knowledge base. The dialog structure is the interface between the user and the system. These interfaces are designed to verbally explain their reasoning, much like a human expert would. The inference engine "drives" the computer to perform search strategies that arrive at various conclusions. The knowledge base is the set of facts and rules (heuristics) about the specific task at hand.

FHWA: The Federal Highway Administration. Responsible for ITS implementations.

Figure of merit (FOM): A performance rating that governs the choice of a device for a particular application. For example, the figure of merit of a magnetic amplifier is the ratio of usable power gain to the control time constant.

FOM: See Figure of merit.

Fuzzy logic: A type of mathematical logic in an expert system that relaxes the requirement that all logical statements must be either completely true or completely false. This permits traffic conditions to be described using qualitative measures rather than rigid binary responses.

Gating techniques: Refers to using an electrical circuit to operate as a selecting switch, allowing conduction only during selected time intervals or when the signal magnitude is within certain limits.

TravTek: Located in Orlando, Florida, TravTek (along with the Pathfinder project in southern California) was the first ITS program in the United States. TravTek was a three-year joint effort of the American Automobile Association, FHWA, Florida DOT, and General Motors. It employed ATIS technologies to maximize consumer use of traffic and service information.

Worst-Case Decision Making: A probabilistic means of predicting the evolution of a controlled dynamic systems state and its environment, using the worst plausible scenario as a basis for allocating resources.

B. ANNOTATED BIBLIOGRAPHY OF SELECTED DATA FUSION REVIEWS

Blackman, S.S. and T.J. Broida. "Multiple Sensor Data Association and Fusion in Aerospace Applications." *Journal of Robotic Systems*. June 1990:(445-85). An in-depth review of data association and data fusion techniques as applied to aerospace technology.

Hackett, J.K. and M. Shah. "Multi-sensor Fusion: A Perspective." *Proceedings 1990 IEEE International Conference on Robotics and Automation*. 13-18 May 1990: Cincinnati, OH. Vol. 2:(1324-30). Classifies and discusses six categories of data fusion applications: scene segmentation, scene representation, 3-D shape, sensor modeling, autonomous robots, and object recognition.

Hager, G.D. "Using Resource-bounded Sensing in Telerobotics." *91 ICAR. Fifth International Conference on Advanced Robotics: Robots in Unstructured Environments*. 19-22 June 1991: Pisa, Italy. Vol. 1:(199-204). Does an excellent job of pointing out some of the limitations of the current technology, especially as applied in unstructured environments (like underwater, outer space, etc.).

Harris, C.J. "Distributed Estimation, Inferencing and Multi-sensor Data Fusion for Real Time Supervisory Control." *Artificial Intelligence in Real-Time Control 1989. Proceedings of the IFAC Workshop*. 19-21 Sept. 1989: Shenyang, China. (19-24). The author reviews fuzzy logic, Bayesian theory, Dempster-Shafer evidential reasoning, and other methods as applied to autonomous guided vehicles (AGVs).

Linn, R.J. and D.L. Hall. "A Survey of Multi-sensor Data Fusion Systems." *Proceedings of the SPIE - The International Society for Optical Engineering*. 1-2 April 1991: Orlando, FL. (13-29). Provides a survey of more than fifty defense-related data fusion systems and summarizes their application and key techniques used. Also presents a taxonomy of fusion techniques according to their fusion level, i.e., the amount of information provided to the human user.

C. SUPPLEMENTAL ANNOTATED BIBLIOGRAPHY

Beckerman, M. "A Bayes-maximum Entropy Method for Multi-sensor Data Fusion." *Proceedings of the 1992 IEEE International Conference on Robotics and Automation*. 12-14 May 1992: Nice, France. IEEE Comput. Soc. Press, 1992. Vol. 2: (1668-1774).

Abstract: The author introduces a Bayes-maximum entropy formalism for multi-sensor data fusion and presents an application of this methodology to the fusion of ultrasound and visual sensor data as acquired by a mobile robot. In this approach the principle of maximum entropy was applied to the construction of priors and likelihoods from data. Distances between ultrasound and visual points of interest in a dual representation were used to define Gibbs likelihood distributions. Both one- and two-dimensional likelihoods are presented and cast into a form which makes explicit their dependence on the mean. The Bayesian posterior distributions were used to test a null hypothesis, and maximum entropy maps used for navigation were updated using the resulting information from the dual representation.

Behringer, R., Holt, V., and D. Dickmanns. "Road and Relative Ego-state Recognition." *Proceedings of the Intelligent Vehicles '92 Symposium*. 29 June-1 July 1992: Detroit, MI. IEEE, 1990 (385-90).

Abstract: A road interpretation module is presented, which is part of a real-time vehicle guidance system for autonomous driving. Based on bifocal computer vision, the complete system is able to drive a vehicle on marked or unmarked roads, to detect obstacles, and to react appropriately. The hardware is a network of 23 transputers, organized in modular clusters. Parallel modules performing image analysis, feature extraction, object modelling, sensor data integration and vehicle control, are organized in hierarchical levels. The road interpretation module is based on the principle of recursive state estimation by Kalman filter techniques. Internal 4-D models of the road, vehicle position, and orientation are updated using data produced by the image-processing module. The system has been implemented on two vehicles (VITA and VaMoRs) and demonstrated in the framework of PROMETHEUS, where the ability of autonomous driving through narrow curves and of lane changing were demonstrated. Meanwhile, the system has been tested on public roads in real traffic situations, including travel on a German Autobahn autonomously at speeds up to 85 km/h.

Belcastro, C.M., Fischl, R., and M. Kam. "Fusion Techniques Using Distributed Kalman Filtering for Detecting Changes in Systems." *Proceedings of the 1991 American Control Conference*. 26-28 June 1991: Boston, MA. American Autom. Control Council, 1991. Vol. 3: (2296-2298).

Abstract: A comparison is made of the performance of two detection strategies that are based on different data fusion techniques. The strategies detect changes in a linear system. One detection strategy involves combining the estimates and error covariance matrices of distributed Kalman filters, generating a residual from the used estimates, comparing this residual to a threshold, and making a decision. The other detection strategy involves a distributed decision process in which estimates from distributed Kalman filters are used to generate distributed residuals which are compared locally to a threshold. Local decisions are made and these decisions are then fused into a global decision. The performance of these two detection schemes is compared, and it is concluded that better performance is achieved when local decisions are made and then fused into a global decision.

Blackman, S.S. and T.J. Broida. "Multiple Sensor Data Association and Fusion in Aerospace Applications." *Journal of Robotic Systems*. June 1990: (445-85).

Abstract: Presents a summary of some of the issues and methods encountered in the use of multiple sensors for surveillance and tracking problems that arise in aerospace and defense. Applications include air traffic control using multiple, internetted, ground-based radar sensors, ship-based air defense systems, and air-to-air systems for drug interdiction and for air combat. The functions of data association and data fusion are central to any multiple-sensor fusion application. The authors address these topics for both collocated and distributed sensing systems. The use of multiple hypothesis tracking (MHT) for data association is discussed as a way of dealing with data association ambiguities. The closely related problem of allocating sensor resources is also addressed, and a general methodology for evaluating multiple sensor tracking system performance is presented.

Booth, D.M., Thacker, N.A., Mayhew, J.E.W., and M.K. Pidcock. "Combining the Opinions of Several Early Vision Modules Using a Multi-layer Perceptron." *International Journal of Neural Networks - Research & Applications*. June-Dec. 1991: (75-80).

Abstract: Deals with the solution of a binary classification problem by acting on the combined evidence of several early vision modules. Each module provides an opinion on the identity of an individual image element based on a specific area of expertise, such as texture, motion, depth, etc. The problems involved in reaching a consensus of opinion are discussed and the activeness of using a trained, multi-layer perceptron as a tool for data fusion is examined. Some preliminary results are reported.

Boyce, D.E., Kirson, A., and J.L. Schofer. "Design and Implementation of ADVANCE: the Illinois Dynamic Navigation and Route Guidance Demonstration Program." *VNIS '91. Vehicle Navigation and Information Systems Conference Proceedings*. 20-23 Oct. 1991: Dearborn, MI. Soc. Automotive Eng., 1991. Vol 1: (415-26).

Abstract: An overview is presented of ADVANCE (Advanced Driver & Vehicle Advisory Navigation Concept), a program to design, implement and evaluate an in-vehicle navigation and route guidance system with

dynamically updated travel time information. The implementation of this program is the largest field demonstration of an Intelligent Transportation System (ITS) conducted thus far. A brief description is given of this demonstration program and the activities planned for its design and test phase.

Broatch, S.A. and A.J. Henley. "An Integrated Navigation System Manager Using Federated Kalman Filtering." *Proceedings of the IEEE 1991 National Aerospace and Electronics Conference NAECON 1991*. 20-24 May 1991: Dayton, OH. IEEE, 1991. Vol. 1: (422-426).

Abstract: A federated Kalman filter architecture has been developed in which Kalman filter processing is distributed among the navigation sensors to be integrated. Each navigation sensor with its Kalman filter can, in conjunction with the reference INS (Inertial Navigation System), be considered as a subsystem which functions as an independent manager. A central data fusion function is used to integrate the information from these navigators. Such a federated architecture can offer a number of advantages over one with a single, central Kalman filter. These advantages include improved failure detection and correction, improved redundancy management, and lower costs for system integration. GEC Avionics has developed a system for the integration of INS with GPS (Global Positioning System) and TRN (Terrain Referenced Navigation), together with other navigation aids. Results are presented to demonstrate the performance and the benefits of using a federated approach.

Brogi, A., Filippi, R., Gaspari, M., and F. Turini. "An Expert System for Data Fusion Based on a Blackboard Architecture." *Expert Systems and Their Applications - Specialized Conference. Artificial Intelligence and Defense, Expert Systems and Maintenance, Expert Systems and Medicine*. 30 May-3 June 1988: Avignon, France (147-65).

Abstract: Data fusion addresses the problem of merging data coming from different sensors with other information sources. In this paper, an approach to data fusion which uses AI techniques is shown. An expert system prototype, merging reports received from a radar and a jammer strobe with a priori known information, is presented. The system is built upon a general blackboard architecture, which has been built on top of Prolog. The characteristics of the blackboard architecture model have allowed the authors to partition all the domain knowledge into cooperating modules and to keep it separated from control knowledge. The handling of probabilistic reasoning, which is fundamental for data fusion problems, has been managed using the Dempster-Shafer theory of evidence. Finally, the implementation environment is constituted by NIP Edinburgh Prolog and C running under Unix 4.2 on a Sun 3/180.

Buede, D.M. and E.L. Waltz. "Benefits of Soft Sensors and Probabilistic Fusion." *Signal and Data Processing of Small Targets 1989. Proceedings of the SPIE - The International Society for Optical Engineering*. 27-29 March 1989: Orlando, FL. SPIE, 1989 (309-20).

Abstract: Describes and quantifies the benefits of soft-decision sensors and probabilistic data fusion relative to hard-decision sensors and nonnumerical (e.g. Boolean logic) data fusion. Hard sensors measure signals and return "yes/no" responses (declarations) based upon decision criteria within each sensor. Soft sensors return a measure of confidence (such as a probability) that quantifies the uncertainty in detection and/or identification. These soft responses are integrated via a fusion algorithm. The composite confidence derived by fusion from all sensors is compared against a single decision criterion to make the detection/identification declaration. A soft sensor suite with Bayesian fusion is shown to provide a 30 percent increase in range at identification. This occurs only when the probabilistic uncertainty regions for sensor measurements overlap. This means more than one sensor is providing probabilistic measurements at a given range for the particular target parameters.

Butini, F., Cappellini, V., and S. Fini. "Remote Sensing Data Fusion on Intelligent Terminals." *European Transactions on Telecommunications and Related Technologies*. Nov.-Dec. 1992: (555-63).

Abstract: This paper focuses on the possibilities offered by intelligent terminals applied to multi-sensor image data processing. The state of the art of remote sensing and its future development are briefly analyzed in order to underline the need for an intelligent use of the large amount of data that will be available in future years. Data fusion is introduced as an interesting technique both to combine data collected by remote sensors and to extract the information which is not available from each separate informative channel. Artificial neural networks are presented as a powerful tool to be used in data fusion processing because of their capability to process data without any a priori information of the data set. An example of neural network processing on multi-sensor airborne data is given in order to show the effective possibility offered by an intelligent terminal in high-level processing of sensor data.

Cameron, A. and H.L. Wu. "Identifying and Localizing Electrical Components: A Case Study of Adaptive Goal-directed Sensing." *Proceedings of the 1991 IEEE International Symposium on Intelligent Control*. 13-15 Aug. 1991: Arlington, VA. IEEE, 1991 (495-500).

Abstract: The ability to reconfigure sensors dynamically between data collection operations (often termed active sensing) enables planning of sensing strategies. Each sensory action will improve knowledge of the environment; hence, each sensory action can be chosen utilizing a larger knowledge base than was available for previous actions. Consequently, a strategy consisting of a sequence of sensory actions can be planned in an adaptive manner, with data obtained from each action influencing the selection of subsequent actions. A system for identifying and localizing electrical components is described which is both adaptive and goal-directed. The mathematical framework of Bayesian decision theory is applied to the problem of selecting appropriate sensor actions in the presence of uncertain knowledge about the environment. This enables a consistent Bayesian framework for reasoning with uncertainty for the associated tasks of world modeling, sensor modeling, data fusion, and the selection of sensory actions.

Capocaccia, G., Damasio, A., Regazzoni, D.S., and G. Vernazza. "Data Fusion Approach to Obstacle Detection and Identification." *Proceedings of the SPIE - The International Society for Optical Engineering*. 7-9 Nov. 1988: Cambridge, MA. SPIE, 1988. Vol. 1003: (409-19).

Abstract: Data fusion is applied to the problem of detecting and identifying obstacles in a static (or slowly changing) known scene. Automatic detection of unexpected objects is of crucial importance in reducing the need for personnel in surveillance stations. Possible applications to the area of rail transportation systems are currently being explored, and results for a level crossing monitoring situation are presented. The authors define a framework that allows the exploitation of multiple sensors or multiple operation modes of a single sensor. As an example, they describe a way of merging the data coming from two channels (the RG bands) of a color video camera, with each providing two intensity images (the actual scene and the "normal" background). The system can profit from the introduction of additional sensors, like a laser range finder to aid in locating obstacles in 3-D space. The proposed system architecture is based on a blackboard organization for both inference and control. Particular care has been exercised in optimizing the data flow through system modules by means of a heterarchical control structure. Object-oriented programming is extensively used to isolate the system's basic units in order to allow future parallel implementation.

Case, E.R., Van Aerde, M., and M. Krage. "Supporting Routines for Modelling the Traffic Responsive Features of the TravTek System using INTEGRATION." *VNIS '91. Vehicle Navigation and Information Systems Conference Proceedings*. 20-23 Oct. 1991: Dearborn, MI. Vol. 2: (681-91).

Abstract: The INTEGRATION simulation model is being applied at Queen's University, on behalf of General Motors Research Labs, as a tool to perform a dynamic traffic simulation study of the TravTek route guidance experiment in Orlando, Florida. While there were several different ways in which the INTEGRATION model itself was adapted to be able to model the dynamic and route guidance features of the TravTek system, the authors focus on describing the associated dynamic modeling routines which needed to be modified and/or developed in order to generate the dynamic inputs to the INTEGRATION model. They describe the need and role of these supporting routines and illustrate that the quality of the TravTek simulation study results is ultimately highly dependent on the capability of the supporting routines to properly generate extensive dynamic input data. Such data are required to properly utilize dynamic traffic simulation models like INTEGRATION.

Chang, E.C.P. "A Neural Network Approach to Freeway Incident Detection." *VNIS '92. The Third International Conference on Vehicle Navigation & Information Systems*. IEEE, 1992 (641-47).

Abstract: Freeway and arterial incidents often occur unexpectedly and cause undesirable congestion and mobility loss, even where surveillance, communications, and control (SC & C) systems are in operation. Automatic incident detection should apply available information observed from

freeway detector stations. The most commonly used method is the comparative or California-type algorithm in which traffic operational characteristics between consecutive detector stations are continuously monitored and closely evaluated. This study explores the neural network approach that applies historical detector data to reduce possible false alarms and lessen the operational impacts of each incident.

Chao, J.J. "Knowledge-based Moving Target Detector." *ISNCR-89. Noise and Clutter Rejection in Radars and Imaging Sensors. Proceedings of the Second International Symposium.* 14-16 Nov. 1989: Kyoto, Japan. Inst. Electron. Inf. Commun., 1990 (520-525).

Abstract: A knowledge-based, moving target detector is proposed. It extracts feature parameters from radar signals. Then, a knowledge base interprets the value of each feature parameter in terms of Dempster-Shafer's (1976) belief or disbelief for the associated hypotheses. Finally, Dempster's (1968) combining rule is employed to the fusion of the decision information.

Chao, J.J., Cheng, C.M., and C.C. Su. "A Moving Target Detector Based on Information Fusion." *Record of the IEEE 1990 International Radar Conference.* 7 -10 May 1990: Arlington, VA. IEEE, 1990 (341-4).

Abstract: Moving target detector (MTD) related multiple-hypothesis testing is considered, and the Dempster-Shafer theory is applied to this problem. Feature parameters are extracted from radar signals, and the value of each feature parameter is interpreted in terms of Dempster-Shafer's belief or disbelief for the associated hypotheses. Using Dempster's combining rule, a generalized likelihood ratio test is derived.

Collins, J.B. and J.K. Uhlmann. "Efficient Gating in Data Association with Multivariate Gaussian Distributed States." *IEEE Transactions on Aerospace and Electronic Systems.* July 1992: (909-16).

Abstract: An efficient algorithm for evaluating the associations between two sets of data with Gaussian error is described, e.g. between a set of measured state vectors and a set of estimated state vectors. A general method is developed for determining, from the covariance matrix, minimal d-dimensional error ellipsoids for the state vectors which always overlap when a gating criterion is satisfied. Circumscribing boxes, or d-ranges for the data ellipsoids are then found and whenever they overlap the association probability is computed. For efficiently determining the intersections of the d-ranges, a multidimensional search tree method is used to reduce the overall scaling of the evaluation of associations. Very few associations that lie outside the predetermined error threshold or gate are evaluated. The search method developed is a fixed Mahalanobis distance search. Empirical tests for variously distributed data in both three and eight dimensions indicate that the scaling is significantly reduced. Computational loads for many large-scale data association tasks can, therefore, be significantly decreased using this or related methods.

Durrant-Whyte, H.F., Rao, B.Y.S., and H. Hu. "Toward a Fully Decentralized Architecture for Multi-sensor Data Fusion." *Proceedings 1990 IEEE International Conference on Robotics and Automation*. 13-18 May 1990: Los Alamitos, CA. IEEE Comput. Soc. Press, 1990. Vol. 2: (1331-1336).

Abstract: A fully decentralized architecture is presented for data fusion problems. This architecture takes the form of a network of sensor nodes, each with its own processing facility, which together do not require any central processor or any central communication facility. In this architecture, computation is performed locally and communication occurs between any two nodes. Such an architecture has many desirable properties, including robustness to sensor failure and flexibility to the addition or loss of one or more sensors. This architecture is appropriate for the class of extended Kalman filter-based (EKF) geometric data fusion problems. The starting point for this architecture is an algorithm which allows the complete decentralization of the multi-sensor EKF equations among a number of sensing nodes. This algorithm is described, and it is shown how it can be applied to a number of different data fusion problems. An application of this algorithm to the problem of multi-camera, real-time tracking of objects and people that are moving through a room is described.

Easthope, P.F., Goodchild, E.J.G., and S.L. Rhodes. "A Computationally Tractable Approach to Real-time Multi-sensor Data Fusion." *Proceedings of the SPIE - The International Society for Optical Engineering*. 27-29 March 1989: Orlando, FL. SPIE, 1989. Vol. 1096: (298-308).

Abstract: A target-oriented method for sensor data fusion is being developed to provide practical, automated, multi-sensor tracking in multiple-target environments of any size. Partitioning by target track offers the greatest scope for processing concurrency and forms the basis of the design.

Fennelly, A.J., Woosley, J.K., McMahon, D.M., Bhuminder, S., and J.W. Wolfsberger. "Multivariate Data Spaces and Multivariable Systems Analysis for Explosive Detection Systems Using X-rays." *Proceedings of the SPIE - The International Society for Optical Engineering*. 23-24 July 1992: San Diego, CA. SPIE, 1992. Vol. 1736: (159-70).

Abstract: The problems of maximizing the probability of detection while minimizing the probability of false alarms ($P_{sub F}$) in the case of explosive device detection for aviation security is addressed. X-ray explosive detection systems (XREDS) are highlighted and difficulties with currently available detection systems are reviewed. The basic problem lies in the use of single-hit, single-phenomenology sensor systems. Cluster analysis, factor analysis, and principal component analysis are applied to provide effective discrimination between explosive devices and false alarm objects. A key analysis is the incorporation of binary cumulative probability of detection to combine the data from several sensors or signatures and avoid a cumulative increase in $P_{sub F}$.

Fincher, D.W. and D.F. Mix. "Multi-sensor Data Fusion Using Neural Networks." *1990 IEEE International Conference on Systems, Man, and Cybernetics*. 4-7 Nov. 1990: Los Angeles, CA. IEEE, 1990 (835-8).

Abstract: A general approach to the use of neural networks for data fusion is outlined. The discussion begins with examples of data fusion problems and a pattern recognition example is given to illustrate the concepts involved in data fusion. The differences between using post- and pre-detection signals and the advantages of using the latter are discussed. How to apply a neural network to the data fusion problem is demonstrated, and experimental results for a character recognition task are given. The general approach applies to a variety of practical situations, including robot navigation and military environment assessment/evaluation.

Hackett, J.K. and M. Shah. "Multi-sensor Fusion: A Perspective." *Proceedings 1990 IEEE International Conference on Robotics and Automation*. 13-18 May 1990: Cincinnati, OH. IEEE, 1990. Vol. 2: (1324-30)

Abstract: A survey of the state of the art in multi-sensor fusion is presented. Papers related to data fusion are surveyed and classified into six categories: scene segmentation, representation, 3-D shape, sensor modeling, autonomous robots, and object recognition. A number of fusion strategies are employed to combine sensor outputs. These strategies range from simple set intersection, logical and operations, and heuristic production rules to more complex methods involving nonlinear, least-squares fits and maximum-likelihood estimates. Sensor uncertainty has been modeled using Bayesian probabilities and support and plausibility involving the Dempster-Shafer formalism.

Hager, G.D. "Using Resource-bounded Sensing in Telerobotics." *91 ICAR. Fifth International Conference on Advanced Robotics: Robots in Unstructured Environments*. 19-22 June 1991: Pisa, Italy. IEEE, 1991. Vol. 1: (199-204).

Abstract: Investigates the use of resource-bounded sensing to increase the performance of telerobotic systems. By examining the role of sensing in telerobotics, the authors isolate several desirable sensing functions to be performed. They then review the state of the art in sensor data fusion and point out some of the limitations of the current technology, particularly regarding its use in unstructured environments. Methods more suitable for unstructured environments require information about the goals of the operator. They also describe what information the operator must supply and how it may be entered into the system.

Haimovich, A.M., Yosko, J., Greenberg, R.J., Parisi, M.A., and D. Becker. "Fusion of Sensors with Dissimilar Measurement/Tracking Accuracies." *IEEE Transactions on Aerospace and Electronic Systems*. Jan. 1993: (245-9).

Abstract: The case of data fusion employing sensors dissimilar in their measurement/tracking errors is considered. It is shown that the fused track performance is similar whether the sensor data are fused at the track level or at the measurement level. The case of a cluster of targets, resolved by one sensor but not the other, is also considered. Under certain conditions the fused track may perform worse than the worst of the individual sensors. A remedy to this problem is presented through modifications of the association algorithm.

Harris, C.J. "Distributed Estimation, Inferencing and Multi-sensor Data Fusion for Real Time Supervisory Control." *Artificial Intelligence in Real-Time Control 1989. Proceedings of the IFAC Workshop.* 19-21 Sept. 1989: Shenyang, China (19-24).

Abstract: Fully-autonomous or supervisory-controlled guided vehicles that utilize on-board intelligent sensing to determine a vehicle's state, the external world, correlate real time events/objects with mapped knowledge, monitor a vehicle's own system health, and compute dynamically its own control strategy, require the use of a wide range of sensors and the means to fuse or integrate disparate sensor databases when they refer to the same object. The author considers a multi-level approach to sensory integration for AGVs: level 1 - local positional estimation, level 2 - sensory consensus, level 3 - sensor fusion, and level 4 - situation assessment.

Harris, C.J. and A.B. Read. "Knowledge-based Fuzzy Motion Control of Autonomous Vehicles." *Artificial Intelligence in Real-Time Control. Proceedings of the IFAC Workshop.* 21-23 Sept. 1988: Swansea, UK (139-44).

Abstract: An intelligent, mobile, land-based autonomous vehicle can be modelled as a hierarchy of multi-sensor data fusion, scene recognition, path planning, navigation and motion control. This paper is directed towards the motion control level in developing rule-based fuzzy logic controllers that are self-adaptive to substantial changes in plant parameters and to inadequacies in physical modelling. It is shown that a land-based vehicle, and its guidance and control, can be modelled as a series of connected, linear, second-order systems for small perturbations in time and motion. Such models and associated control laws are inadequate for motion in unstructured environments or for large, slew, angular movements. By utilizing a fuzzy decision/control algorithm through a fuzzy-based production system, it is shown that effective real-time lateral motion control is achievable for a wide range of plant parameters/models. Computational aspects of sample rates, number of operations and storage requirements for a reconfigurable rule-based fuzzy logic controller are also considered.

Hazlett, T.L., Cofer, R.H., and H.K. Brown. "Explanation Mode for Bayesian Automatic Object Recognition." *Automatic Object Recognition II. Proceedings of the SPIE - The International Society for Optical Engineering.* 22-24 April 1992: Orlando, FL. SPIE, 1992 (258-268).

Abstract: Long-standing results show that the paradigm of Bayesian object recognition is truly optimal in a minimum probability of error sense. To a large degree, the Bayesian paradigm achieves optimality through adroit fusion of a wide range of lower informational data sources to give a higher quality decision, a very "expert system"-like capability. When various sources of incoming data are represented by C++ classes, it becomes possible to backtrack automatically the Bayesian data fusion process, assigning relative weights to the more significant data and their combinations. A C++ object oriented engine is then able to synthesize "English"-like textual description of the Bayesian reasoning suitable for generalized presentation. Key concepts and examples are based on an actual object recognition problem.

Hoballah, I.Y. and P.K. Varshney. "Distributed Bayesian Signal Detection." *IEEE Transactions on Information Theory*. Sept. 1989: (995-1000).

Abstract: The signal detection problem is considered for a case in which distributed sensors are used and a global decision is desired. Local decisions from the sensors are fed to a data fusion center, which yields a global decision based on a fusion rule. A Bayesian formulation of the problem is considered, and a person-by-person optimization of the overall system is carried out. The special case of identical detectors with independent observations is considered, as well. An illustrative example is presented.

Hughes, T.J. "Sensor Fusion in a Military Avionics Environment." *Measurement and Control*. Sept. 1989: (203-205).

Abstract: The Tactical Decision Aid is an aid to pilots under attack by surface-to-air missiles. It handles certain decisions and leaves others to the pilot. It is programmed with specific pre-mission intelligence and must perform sensor data fusion, threat assessment and planning. The article concentrates on the data fusion function. The system must identify threats where possible and distinguish them from non-threatening objects. Uncertainty, resulting from incomplete knowledge and imprecision and inconsistency of data must be taken into account. Data association, correlation and combination are performed. Dempster-Shafer theory is found to be the most appropriate method for updating an object's position.

Jewitt, T.W. "Data Fusion of Outputs Provided by a Distributed Field of Passive Sensors." *Proceedings of the SPIE - The International Society for Optical Engineering*. 20-22 April 1992: Orlando, FL (348-59).

Abstract: A clustering algorithm for this purpose exploits the tendency of spatial clusters, corresponding to targets, to be formed by the set of all possible localizations computed by triangulation of sensor detections taken two at a time. The algorithm incorporates both a priori and a posteriori information relevant to the task, but differs from the Bayesian approach in being well suited to mapping to an MIMD processing architecture. A simulation system is described, and its results are summarized.

Kessaci, A., Farges, J.L., and J.J. Henry. "On Line Estimation of Turning Movements and Saturation Flows in PRODYN." *Control, Computers, Communications in Transportation. Papers from the IFAC/IFIP/IFORS Symposium*. 19-21 Sept. 1989: Paris, France. IFAC. 1990 (191-7).

Abstract: PRODYN is the French real-time traffic control algorithm developed by CERT and assessed through ZELT experimental field tests in Toulouse. It is based on dynamic programming sub-system optimization and decentralized coordination. The real-time optimization is implemented on a rolling horizon and state variables, like queues, are estimated by Bayesian techniques. As PRODYN still requires manual introduction of traffic parameters, like turning movement ratios (TMR) and saturation flow rates (SFR), the authors have developed real-time estimation algorithms for those parameters using data from existing magnetic loop sensors. Results of the study on simulation show that the control efficiency is strongly affected by parameter variations. TMR estimation methods based on either the least-square minimization or the Kalman filtering technique are presented.

Kim, K. "Bayesian Inference Network: Applications to Target Tracking." *Proceedings of the SPIE - The International Society for Optical Engineering*. 20-22 April 1992: Orlando, FL. SPIE, Vol. 1698: (360-71).

Abstract: This paper provides a guideline for applying data fusion techniques to a practical problem: the fusion of target identification attribute measurements. Formation of a consensus function is presented and followed by construction of an hierarchical, probabilistic network for computing a joint probability density. An identification fusion processing approach is described and integrated into a generalized track/data association algorithm.

Kirson, A., Smith, B.C., Boyce, D., and J. Shofer. "The Evolution of ADVANCE." *VNIS '92. The Third International Conference on Vehicle Navigation & Information Systems*. IEEE, 1992 (516-23).

Abstract: ADVANCE is a public/private sector partnership - the first of its kind in North America - established to field test many aspects of dynamic route guidance. It is being implemented in the Chicago area and is sponsored by the Federal Highway Administration and the Illinois DOT, among others. Officially launched on July 9, 1991, ADVANCE will be implemented in two phases. Phase I will deploy a 20-vehicle test fleet equipped with dynamic route guidance systems which will interact with a preliminary version of the Traffic Information Center (TIC) through the RF infrastructure. Phase I is scheduled to be operational by mid-1993. Phase II, expected to start in mid-1993, will deploy up to 5,000 privately-owned vehicles with dynamic route guidance systems and will continue until July 1996.

Kraiss, K.F. and H. Kuttelwesch. "Identification and Application of Neural Operator Models in a Car Driving Situation." *IJCNN '91 Seattle: International Joint Conference on Neural Networks*. 8-14 July 1991: Seattle, WA. Vol. 2: (917).

Abstract: Summary form only. The authors investigated whether neural networks are applicable as operator models in man-machine systems. A two-lane, car-driving task was used as an experimental paradigm. Various network architectures were tested. In particular, a combination of functional link and back propagation is proposed as a novel, rapidly-trainable structure. It is shown experimentally that individual human driving characteristics are identifiable from the input/output relations of the trained networks. The authors conclude that neural nets are candidates for operator models. The applicability of such models to serve as information sources for driver assistant systems is demonstrated.

Leardi, C., Murino, V., and C.S. Regazzoni. "Scene Interpretation by Perceptual Goals Integration." *Proceedings of the IASTED International Symposium Artificial Intelligence Application and Neural Networks - AINN '90*. 25-27 June 1990: Zurich, Switzerland (133-6).

Abstract: A distributed blackboard system (DOORS: Distributed Object Oriented Multi-sensor Recognition System) has been developed to

integrate information provided by multiple sensors (e.g. RGB camera, infrared camera, etc.). Hierarchical frame networks are used as a common representation format for multi-level data fusion purposes. DOORS is composed of a set of modules, with each containing procedural knowledge to build up scene interpretation at a specific level of abstraction. Rough sensor data are transformed into symbolic representations (e.g. fused data) by local fusion processes, which integrate multi-sensor observations. In the current application, an autonomous vehicle is considered, and a terrain map of the environment mission is made available. The interpretation process is performed by considering outdoor natural scenes of the test bed environment.

Lee, R.H. and R. Leahy. "Segmentation of Multi-sensor Images." *Sixth Multidimensional Signal Processing Workshop*. 6-8 Sept. 1989: Pacific Grove, CA. IEEE, 1989, (23).

Abstract: Summary form only. Regions of the images observed by each sensor are modeled as noncausal Gaussian Markov random fields (GM-RFs), and labeled images are assumed to follow a Gibbs distribution. The region labeling algorithms then become functions of model parameters, and the multi-sensor image segmentation problems become inference problems, given multi-sensor parameter measurements and local spatial interaction evidence. Two different multi-sensor image segmentation algorithms - maximum a posteriori (MAP) estimation and the Dempster-Shafer evidential reasoning technique - have been developed and evaluated. The Bayesian MAP approach uses an independent opinion pool for data fusion and a deterministic relaxation to obtain the map solution. The Dempster-Shafer approach uses Dempster's rule of combination for data fusion, belief intervals and ignorance to represent confidence of labeling, and a deterministic relaxation scheme that updates the belief intervals. Simulations with mosaic images of real textures and with anatomical magnetic resonance images have been carried out.

Leung, D.S.P. and D.S. Williams. "A Multiple Hypothesis Based Multiple Sensor Spatial Data Fusion Algorithm." *Automatic Object Recognition. Proceedings of the SPIE - The International Society for Optical Engineering*. 3-5 April 1991: Orlando, FL. SPIE, 1991. Vol. 1471: (314-325).

Abstract: An algorithm for correlating all tracks from different sensors on the basis of their spatial characteristics is presented. The technique is an extension of the multiple hypothesis technique for tracking multiple targets using a single sensor in a cluttered environment: all feasible correlation hypotheses are considered and maintained for at least a short period. The likelihood for these hypotheses to be correct is evaluated and updated with the arrival of new data. The unlikely hypotheses are discarded periodically, and the most highly probable hypotheses are retained. Using Kalman filtering techniques, the state estimates of each of the fusion hypotheses that survive will have a smaller error covariance than any of the tracks from which it was derived.

Lin, C.F., Yang, C., Cloutier, J., Evers, J.H., and R. Zachery. "Fusion of Hybrid Data in Mode Estimation." *Proceedings of the 30th IEEE Conference on Decision and Control*. 11-13 Dec. 1991: Brighton, UK. IEEE, 1991. Vol. 3: (3072-81).

Abstract: The adaptive management of a multi-sensor system is indispensable for ensuring the synergistic use of multiple sensors to improve system performance. Two aspects of a multi-sensor system are addressed. First, the problem of adaptive management of multiple sensors as a function of environmental and operational conditions is considered. Second, an investigation of various fusion schemes at different levels is performed by considering the use of hybrid measurements which are typically continuous-valued and discrete-valued. The hybrid-measurement-based estimation of the jump mode, which suitably describes environmental and operational condition changes, is illustrated through simulation. It is concluded that the improved mode estimation can be used by a multi-sensor adaptive management system for environmental adaptation.

Linn, R.J. and D.L. Hall. "A Survey of Multi-sensor Data Fusion Systems." *Proceedings of the SPIE - The International Society for Optical Engineering*. 1-2 April 1991: Orlando, FL. SPIE, 1991. Vol. 1470: (13-29).

Abstract: Multi-sensor data fusion is the integration of data from multiple sensors to perform inferences which are more accurate and specific than that available by processing single-sensor data. Levels of inference range from target detection and identification to higher-level situation assessment and threat assessment. In recent years, data fusion systems have been developed for a variety of applications including IFFN, C/sup3/I, tactical resource management, and strategic warning, as well as non-military applications. This paper provides a survey of more than fifty data fusion systems and summarizes their application, development environment, system status, and indicates key techniques utilized. The techniques are mapped to a taxonomy previously developed by Hall and Linn (1990). These techniques include positional fusion techniques, such as association and estimation, and identity fusion methods, including statistical methods, nonparametric methods, and cognitive based techniques. An assessment of the state of fusion system development is provided.

Liu, L.J., Gu, Y.G., and J.Y. Yang. "Inference for Data Fusion." *Neural and Stochastic Methods in Image and Signal Processing. Proceedings of the SPIE - The International Society for Optical Engineering*. 20-23 July 1992: San Diego, CA. SPIE, 1992 (670-677).

Abstract: Data fusion has been widely used in various fields of automation. The authors describe a multi-sensor integration system: a range and intensity image processing system, which can be used for object recognition and classification. In data fusion processing, a new method called the generalized evidence inference method is used by the system. The method presented here unifies both Bayesian theory and Dempster-Shafer's evidential reasoning (DSER) for the combination of information from diversified sources and overcomes the disadvantages of both approaches. The authors adopt the following three approaches: Bayesian theory, the DSER, and a unified approach to fuse the reports in the system for object recognition and classification. Results are compared and analyzed.

Llinas, J. and R.T. Antony. "Blackboard Concepts for Data Fusion Applications." *International Journal of Pattern Recognition and Artificial Intelligence*. April 1993 (285-308).

Abstract: While the specific definitions of a "situation assessment" (SA) and a "threat assessment" (TA) have proven to be problem-dependent for most defense applications, these notions generally encompass a large quantity of knowledge which reflect the dynamic constituency-dependency relationships among objects of various classes, as well as events and activities of interest. This paper expands on the processes and techniques involved in SA and TA analysis and describes, from various points of view, why the blackboard paradigm is properly applicable to problems of SA and TA analysis. This assessment identifies various tradeoff factors in applying blackboard concepts to data fusion-related reasoning processes. Specific research and development by the authors and synthesis of the results of a survey on data fusion applications has led to the formulation of a recommended generic, ideal blackboard architecture for the defense problems described in the paper.

Lure, Y.M.F., Grody, N.C., Chiou, Y.S.P., and H.Y.M. Yeh. "Data Fusion with Artificial Neural Networks for Classification of Earth Surface from Microwave Satellite Measurements." *Telematics and Informatics*. Summer 1993: (199-208).

Abstract: A data fusion system employing artificial neural networks is used for fast and accurate classification of five Earth surface conditions and surface changes based on seven Special Sensor Microwave Imager (SSMI) multichannel microwave satellite measurements. The measurements include brightness temperatures at 19, 22, 37, and 85 GHz at both horizontal and vertical polarizations (only vertical at 22 GHz). The seven channel measurements are processed through a convolution computation such that all measurements are located at same grid. Five surface classes including non-scattering surface, precipitation over land, over ocean, snow, and desert are identified from ground-truth observations. The system processes sensory data in three consecutive phases: (a) preprocessing to extract feature vectors and enhance separability among detected classes; (b) preliminary classification of Earth surface patterns using two separate and parallel-acting classifiers: back-propagation neural network and binary decision tree classifiers; and (c) data fusion of results from preliminary classifiers to obtain the optimal performance in overall classification. Both the binary decision tree classifier and the fusion processing centers are implemented by neural network architectures. The fusion system configuration is an hierarchical, neural network architecture in which each functional neural net handles different processing phases in a pipe-lined fashion.

Maitre, B. and H. Laasri. "Cooperating Expert Problem-solving in Blackboard Systems: ATOME Case Study." *Decentralized A.I. Proceedings of the First European Workshop on Modelling Autonomous Agents in a Multi-Agent World*. 16-18 Aug. 1989: Cambridge, UK. North-Holland: Amsterdam, Netherlands, 1990 (251-63).

Abstract: Blackboard systems are a kind of medium-gained, multi-agent system that deals with multiple cooperating sources of knowledge. They have been successfully used in a variety of applications, including speech recognition, computer vision, data fusion, situation assessment, etc. Many people in the AI community regard them as the most promising scheme for the next generation of knowledge-based systems. The blackboard systems developed by AI researchers fall somewhere in the range between

being purely efficient and purely flexible. At the purely efficient end are systems in which a scheduler follows a rigorous procedure, scheduling a planned sequence of knowledge sources' activities that monotonically assemble compatible solution elements. At the purely flexible end are systems in which a scheduler applies many conflicting heuristics that are extremely sensitive to unanticipated problem-solving states, scheduling activities that assemble elements out of which a complete solution only gradually emerges. The system employed by the authors falls between these extremes. In order to reconcile efficiency and flexibility, the authors propose a meta-level architecture which balances both of these conflicting behaviors by organizing knowledge in an hierarchical manner and by managing them through use of a hybrid multistage controller.

Mammano, F.J. and R. Sumner. "Pathfinder Status and Implementation Experience." *VNIS '91. Vehicle Navigation and Information Systems Conference Proceedings*. 20-23 Oct. 1991: Dearborn, MI. Vol. 1: (407-13).

Abstract: An overview is presented of the Pathfinder system, which has been installed in Los Angeles, California. The Pathfinder system delivers roadway congestion messages to drivers. These messages are either speech or text. The driver can switch between these at any time by using buttons on the Etak monitor. The manner in which the messages are generated is discussed along with speech production, communication testing and display mounting.

Mammano, F. and R. Sumner. "Pathfinder System Design." *VNIS '89. Conference of the First Vehicle Navigation & Information Systems*. 11-13 Sept. 1989: Toronto, Canada (484-8).

Abstract: The authors describe an experimental project designed to test the feasibility of using the latest technological devices to aid motorists in avoiding urban traffic congestion. The basic objectives are to design, install, and operate a system that will provide real-time information to motorists in their vehicles; to evaluate drivers' responses to the information provided; to evaluate the utility of using vehicles as a source of information on traffic conditions; and to evaluate a computer-assisted method of combining real-time traffic information from various sources. The experiment is taking place in the Smart Corridor, a 13-mile (20 km) stretch of the freeway between Santa Monica and downtown Los Angeles. Twenty-five vehicles, equipped with an in-vehicle navigation system using a modified Etak map display to show traffic congestion information, will be used. After a system overview, descriptions are given of the vehicle system, the central system, and the communication system. Details of the experimental evaluation are given.

Martinez, D., Esteve, D., and H. Demmou. "Evaluation of a Modular Multilayer Architecture for Recognizing Dangerous Situations in Car Driving." *Neuro-Nimes '90. Third International Workshop*. 12-16 Nov. 1990: Nimes, France (71-80).

Abstract: This work falls within the framework of the programs Drive and Prometheus, whose global aim is the development of a car co-pilot. The authors propose a modular neural architecture to recognize dangerous car

driving situations in real time. The architecture of the system is built with the help of an expert with detailed knowledge of the problem. This makes it possible to decompose a task into several independent subtasks and to allocate a distinct neural module to learn each subtask. They show that the application of this modular approach to recognize dangerous driving situations on a motorway improves the system's performance.

Moutarlier, P. and R. Chatila. "Stochastic Multisensory Data Fusion for Mobile Robot Location and Environment Modelling." *Robotics Research: Fifth International Symposium*. 28-31 Aug. 1989: Tokyo, Japan. MIT Press, 1990 (85-94).

Abstract: Presents a rigorous, formal approach to deal with stochastic sensory data fusion and develops it in the context of environment map-making and robot location from noisy data. The approach relies first on using a unique reference frame wherein all object frames (and the robot) are known. The authors demonstrate, however, that local relationships are preserved. A formalism for manipulating uncertain data (related to Kalman filtering but taking into account spatio-temporal correlations) is developed. It is applied to the problem of incremental map-making after the introduction of a general definition of sensor observations. Non-linearities are addressed, as well as biases due to linearization, that could contaminate the model.

Niehaus, A. and R.F. Stengel. "Probability-based Decision Making for Automated Highway Driving." *VNIS '91. Vehicle Navigation & Information Systems Conference Proceedings*. 20-23 Oct. 1991: Dearborn, MI. Soc. Automotive Eng.: Warrendale, PA, 1991. Vol. 2: (1125-36).

Abstract: Real-time, rule-based guidance systems for autonomous vehicles on limited-access highways are investigated. The goal of these systems is to plan trajectories that are safe while satisfying drivers' requests based on stochastic information about the vehicle state and the surrounding traffic. A rule-based system is used for high-level planning. Given a stochastic model of the traffic situation driven by current measurements, the probable evolution of traffic and the best trajectory to follow are predicted. Simulation results assess the impact of uncertain knowledge about traffic on the performance of the guidance system, showing that uncertainty can and must be taken into account.

Nijhuis, J., Hoffinger, B., Neussber, S., and A. Siggelkow. "A VLSI Implementation of a Neural Car Collision Avoidance Controller." *IJCNN '91 Seattle: International Joint Conference on Neural Networks*. 8-14 July 1991: Seattle, WA. Vol 1: (493-9).

Abstract: The authors present a neural solution to the car collision avoidance problem. The complete path design from problem identification to hardware implementation is discussed. It is shown that a thorough study of the control task leads to a well-chosen representation for the environment data (network input) and the control directives (network output) so that car dynamics are handled and the learning and generalization capabilities of the neural network are fully exploited. The selection of a suitable network topology for the control problem is presented. The authors discuss the learning strategy and the construction of the learning set. After a functioning controller is considered, they discuss the mapping of the simulated network on a VLSI layout.

Payne, T. "Central Fusion of Sensor Information Using Reasoned Feedback." *Complex Systems: From Biology to Computation*. IOS Press: Amsterdam, Netherlands, 1993 (248-59).

Abstract: A consistent approach is presented for the fusion of multi-sensor information. The fusion process allows for different sensors which can be located at different sites and have little to no overlap in their coverage. The information from each sensor is processed locally to remove noise and generate hypotheses about objects in its field of view. These hypotheses are transmitted to a central location where they are fused using Shafer-Dempster reasoning. The reasoned conclusion of this data fusion is fed back to the local processor at each sensor to improve future hypothesis generation. Although this approach is applicable to almost any type of sensor system, to maintain clarity the examples presented assume that visual system, like IR arrays or television sensors, are being used.

Puente, E.A., Moreno, L., Salichs, M.A., and D. Gachet. "Analysis of Data Fusion Methods in Certainty Grids: Application to Collision Danger Monitoring." *Proceedings IECON '91. 1991 International Conference on Industrial Electronics, Control and Instrumentation*. 28 Oct.-1 Nov. 1991: Kobe, Japan. IEEE, 1991. Vol. 2: (1133-7).

Abstract: The authors focus on the use of occupancy grid representation to maintain and combine the information acquired from sensors about the environment. This information is subsequently used to monitor robot collision danger risk and take that risk into account to initiate the appropriate response maneuver. The occupancy grid representation uses a multidimensional tessellation of space into cells, where each cell stores some information about its state. A general model associates a random vector that encodes multiple properties in a cell state. If the cell property is limited to occupancy, it is usually called occupancy grid. Two main approaches have been used to model the occupancy of a cell: probabilistic estimation and the Dempster-Shafer theory of evidence. Probabilistic estimation and some combination rules based on the Dempster-Shafer theory of evidence are analyzed and their possibilities compared.

Rillings, J.H. and J.W. Lewis. "TravTek." *VNIS '91. Vehicle Navigation and Information Systems Conference Proceedings*. 20-23 Oct. 1991: Dearborn, MI. Vol. 2: (729-37).

Abstract: A description is given of TravTek, a joint public-private sector project intended to develop, test, and evaluate an integrated advanced driver information system and supporting infrastructure. TravTek will provide drivers of 100 specially-equipped 1992 Oldsmobile Tornados with navigation, real-time traffic information, route guidance, and motorist information services. The system begins operation in Orlando, Florida, in January 1992.

Sarma, V.S. and S. Raju. "Multisensor Data Fusion and Decision Support for Airborne Target Identification." *IEEE Transactions on Systems, Man and Cybernetics*. Sept.-Oct. 1991: (1224-30).

Abstract: A knowledge-based approach and a reasoning system for multi-sensor data fusion is presented. The scenario for the study is an air-land battlefield situation. A data fusion system obtains data from a variety of sensors. A Dempster-Shafer approach for representing and combining data is found appropriate for combining uncertain information from disparate sensor sources at different levels of abstraction. Evidential reasoning allows confidence levels to be assigned to sets of propositions rather than just N mutually exclusive propositions. The software has been developed and tested in the LISP language. The results illustrate the advantages of using multiple sensors in terms of increased detection probability, greater spatial and temporal coverage, and heightened reliability.

Schlachta, H.B. and Studenny, J. "Interoperability Versus Integration of Omega and GPS." *Journal of Navigation*, May 1990 (229-237).

Abstract: The integration of Omega and GPS sensors into a single navigational system offers the advantages of good accuracy under almost all signal conditions, low capital investment, and certifiable worldwide navigation. The accuracy of the existing Omega network can be improved progressively as GPS satellite coverage is fully implemented. Eventually, the same equipment can provide full GPS navigation accuracy with Omega as a back-up. This paper proposes a method of further improving the overall accuracy and reliability of Omega-GPS navigation. The concepts of Omega-GPS integration, interoperability, modes of operation, and Kalman filter data fusion are presented. Four interoperability modes of operation and their ability to improve navigation reliability are discussed.

Sikka, D.I., Varshney, P.K., and V.C. Vannicola. "A Distributed Artificial Intelligence Approach to Object Identification and Classification." *Proceedings of the SPIE - The International Society for Optical Engineering*. 28-29 March 1989: Orlando, FL (73-84).

Abstract: The authors present an application of distributed artificial intelligence (DAI) tools to a data fusion and classification problem. Their approach is to use a blackboard for information management and hypotheses formulation. The blackboard is used by the knowledge sources (KSs) for sharing information and posting hypotheses, just as human experts sitting around a table would do. The simulation performs classification of an aircraft (AC) - after identifying it by its features - into disjoint sets (object classes) comprised of the five commercial ACs: Boeing 747, Boeing 707, DC10, Concord and Boeing 727. A situational database is characterized by experimental data available from the three levels of expert reasoning. Ohio State University Electro Science Laboratory provided this experimental data. To validate the architecture presented, two KSs for modeling the sensors, aspect angle polarization feature, and the ellipticity data are employed. The system has been implemented on Symbolics 3645, under Genera 7.1, in Common LISP.

Stamenkovich, M. "An Application of Artificial Neural Networks for Autonomous Ship Navigation Through a Channel." *VNIS '91. Vehicle Navigation and Information Systems Conference Proceedings*. 20-23 Oct. 1991: Dearborn, MI. Vol. 1: (475-81).

Abstract: A neural network model based on reinforcement learning is investigated for use as a shipboard autonomous channel navigator. The mode used consists of two, neuron-like elements. The basic learning scheme involves learning with a critic. The network consists of an adaptive critic element (ACE) and an adaptive search element (ASE). The ASE explores the channel region while the ACE criticizes the actions of the ASE and tries to predict failures of the ASE's attempt to navigate. The neural network model developed has been shown to be useful through software simulation with graphical feedback. A similar implementation could have applications in many electronic mapping systems utilizing vector information. The performance of such a system is investigated, along with its adaptability to new channels.

Sumner, R. "Data Fusion in Pathfinder and TravTek." VNIS '91. *Vehicle Navigation and Information Systems Conference Proceedings*. 20-23 Oct. 1991: Dearborn, MI. Soc. Automotive Eng.: Warrendale, PA, 1991. Vol. 1: (71-5).

Abstract: A description is presented of the data fusion process and the manner in which it is applied in the Pathfinder and TravTek projects. In the TravTek system, travel times are transmitted to all vehicles. In the Pathfinder system, congestion levels are transmitted to all vehicles. These transmissions are broadcast once per minute. The data sources for these two Intelligent Transportation Systems (ITS) are described.

Zadeh, L.A. "Fuzzy Sets." *Inform. Control*. 1965: (338-53).

Abstract: The authors describe an algorithm for implementing a multi-sensor system in a model-based environment with consideration of the constraints. Based on an environment model, geometric features and constraints are generated from a CAD model database. Sensor models are used to predict sensor response to certain features and to interpret raw sensor data. A constrained MMS (minimum mean squared) estimator is used to recursively predict, match, and update feature location. The effects of applying various constraints in estimation are shown by a simulation system mounted on a robot arm for localization of known object features.

Zhu, Q., Huang, Y., and M. Payne. "An Expanded Dempster-Shafer Reasoning Technique for Image Feature Integration and Object Recognition." *Neural and Stochastic Methods in Image and Signal Processing. Proceedings of the SPIE - The International Society for Optical Engineering*. 20-23 July 1992: San Diego, CA. SPIE, 1992 (36-47).

Abstract: Fusion of information from multiple sources has been one of the key steps to the success of general vision systems. It is also a problem for the development of color image understanding algorithms that make full use of the multichannel color data for object recognition. The authors present a feature integration system characterized by a hybrid combination of a statistic-based reasoning technique and a symbolic logic-based inference method. A competitive evidence enhancement scheme is used in the process to fuse information from multiple sources. The scheme expands Dempster-Shafer's function of combination and improves the reliability of object recognition. When applied to integration of object features extracted from the multiple spectra of the color images, the system alleviates the drawback of the traditional Bayesian classification system.

Zhu, Q. and E.S. Lee. "Dempster-Shafer Approach in Propositional Logic." *International Journal of Intelligent Systems*. March 1993 (341-9).

Abstract: A general framework of uncertainty reasoning based on Dempster-Shafer's theory is proposed in the context of logic calculus. Under this framework, any inference can be conducted without much computational complexity. Furthermore, it avoids the problems of considering conflicting information and a common universe when two pieces of evidence are combined.

