

Return to TRAC  
Library



WASHINGTON STATE **TRANSPORTATION** CENTER

# HOV EVALUATION AND MONITORING Phase IV

**WA-RD 456.1**

Annual Data Report  
**AUGUST, 1998**



University of  
Washington



Washington State  
University



Washington State  
Department of Transportation

**TECHNICAL REPORT STANDARD TITLE PAGE**

1. REPORT NO. <b>WA-RD 456.1</b>		2. GOVERNMENT ACCESSION NO.		3. RECIPIENT'S CATALOG NO.	
4. TITLE AND SUBTITLE <b>HOV EVALUATION AND MONITORING IV</b>				5. REPORT DATE <b>August 1998</b>	
				6. PERFORMING ORGANIZATION CODE	
7. AUTHOR(S) <b>William W. Brown, Eldon L. Jacobson</b>				8. PERFORMING ORGANIZATION REPORT NO.	
9. PERFORMING ORGANIZATION NAME AND ADDRESS <b>Washington State Transportation Center (TRAC) University of Washington, Box #354082 University District Building; 1107 NE 45th Street, Suite 535 Seattle, Washington 98105-4631</b>				10. WORK UNIT NO.	
				11. CONTRACT OR GRANT NO. <b>T9903, Task 82</b>	
12. SPONSORING AGENCY NAME AND ADDRESS <b>Washington State Department of Transportation Transportation Building, MS 47370 Olympia, Washington 98504-7370</b>				13. TYPE OF REPORT AND PERIOD COVERED <b>Annual data report</b>	
				14. SPONSORING AGENCY CODE	
15. SUPPLEMENTARY NOTES <b>This study was conducted in cooperation with the U.S. Department of Transportation, Federal Highway Administration.</b>					
16. ABSTRACT <p>This report presents and summarizes the data collected in fulfillment of the requirements for the Washington State Department of Transportation grant "HOV Lane Evaluation and Monitoring." This report provides the information necessary to analyze HOV lane performance and development. Data collection results and analysis are presented, followed by conclusions and recommendations.</p> <p>The data contained herein were collected during Phase I, Phase II, Phase III, and Phase IV of the high occupancy vehicle lane (HOV) monitoring project (July 1992-June 1998). The data collection methodology is described in the final report, "HOV Monitoring and Evaluation Tool." Included in this report are the following primary and secondary measures of HOV lane performance: (1) average vehicle occupancy data, (2) travel time data, (3) public opinion survey results, (4) transit ridership data, (5) enforcement, compliance, and adjudication data, and (6) accident data. Data collection issues and their implications for data availability are discussed.</p> <p>It is important to note that this report does not evaluate the HOV lane system in the Puget Sound region. Rather, it is a compilation of the data necessary to conduct a meaningful evaluation. Although an analysis of public opinion, transit ridership, and enforcement data is provided, the report's primary purpose is to simply present the data and discuss issues associated with its use, -not to provide an extensive analysis.</p>					
17. KEY WORDS <b>High occupancy vehicle, HOV, HOV lane evaluation, traffic observation, HERO, Freeway travel times</b>			18. DISTRIBUTION STATEMENT <b>No restrictions. This document is available to the public through the National Technical Information Service, Springfield, VA 22616</b>		
19. SECURITY CLASSIF. (of this report) <b>None</b>		20. SECURITY CLASSIF. (of this page) <b>None</b>		21. NO. OF PAGES <b>386</b>	22. PRICE

**Annual Data Report**  
Research Project T9903, Task 82  
HOV Lane Evaluation and Monitoring  
<http://www.wsdot.wa.gov/eesc/atb/atb/hov/Titlepg.html>

**HOV EVALUATION AND MONITORING**  
**Phase IV**

by

William W. Brown  
Project Associate  
**Washington State Transportation Center (TRAC)**  
University of Washington, Box 354802  
University District Building  
1107 NE 45th Street, Suite 535  
Seattle, Washington 98105-4631

**Washington State Department of Transportation**  
Technical Monitor  
Eldon L. Jacobson  
Field Operations Support Service Center  
Traffic Office, Advanced Technology Branch  
1107 NE 45th Street, Suite 535  
Seattle, Washington 98105-4631

Prepared for

**Washington State Transportation Commission**  
Department of Transportation  
and in cooperation with  
**U.S. Department of Transportation**  
Federal Highway Administration

**August 1998**

## **DISCLAIMER**

The contents of this report reflect the views of the authors, who are responsible for the facts and the accuracy of the data presented herein. The contents do not necessarily reflect the official views or policies of the Washington State Transportation Commission, Department of Transportation, or the Federal Highway Administration. This report does not constitute a standard, specification, or regulation.

# TABLE OF CONTENTS

<b>HOV LANE EVALUATION AND MONITORING.....</b>	<b>1</b>
<b>ABSTRACT.....</b>	<b>1</b>
<b>EXECUTIVE SUMMARY.....</b>	<b>2</b>
<i>Recommendations.....</i>	<i>5</i>
<b>CHAPTER ONE: INTRODUCTION AND RESEARCH APPROACH.....</b>	<b>7</b>
PURPOSE AND PRODUCTS.....	7
MEASURES OF EFFECTIVENESS.....	7
DATA COLLECTION.....	11
REPORT ORGANIZATION.....	14
<b>CHAPTER TWO: BASELINE VEHICLE OCCUPANCY DATA.....</b>	<b>15</b>
OCCUPANCY DATA AVAILABILITY.....	18
<i>Scheduling.....</i>	<i>18</i>
<i>Visibility.....</i>	<i>19</i>
<i>Mainline Observations.....</i>	<i>20</i>
<i>Ramp Observations.....</i>	<i>21</i>
AVERAGE CAR OCCUPANCY SITES.....	23
<i>I-5 North Corridor.....</i>	<i>23</i>
<i>I-5 Downtown Corridor.....</i>	<i>23</i>
<i>I-5 South Corridor.....</i>	<i>25</i>
<i>SR 520 Corridor.....</i>	<i>25</i>
<i>I-90 Corridor.....</i>	<i>26</i>
<i>I-405 Corridor.....</i>	<i>27</i>
<i>I-405 South Corridor.....</i>	<i>27</i>
<i>I-405 Central Corridor.....</i>	<i>29</i>
<i>I-405 North Corridor.....</i>	<i>30</i>
<i>Outlying Locations.....</i>	<i>30</i>
CONCLUSIONS AND RECOMMENDATIONS.....	31
<b>CHAPTER THREE: AVERAGE CAR OCCUPANCY DATA ANALYSIS.....</b>	<b>35</b>
ANALYSIS METHODOLOGY.....	36
TIME OF THE YEAR.....	37
LANE ANALYSIS.....	37
TIME OF DAY.....	38
DAY OF THE WEEK.....	39
YEARLY CHANGES.....	39
CONCLUSIONS.....	39
<b>CHAPTER FOUR: TRAVEL TIME DATA.....</b>	<b>41</b>
BASELINE TRAVEL TIMES.....	41
<i>Data Availability.....</i>	<i>43</i>
<i>Visibility.....</i>	<i>44</i>
<i>Observation Session Length.....</i>	<i>44</i>
<i>Study Section Length.....</i>	<i>45</i>
BASELINE TRAVEL TIME SITES.....	45
<i>I-5 North Corridor.....</i>	<i>45</i>
<i>I-5 Downtown Corridor.....</i>	<i>46</i>
<i>I-5 South Corridor.....</i>	<i>48</i>
<i>SR 520 Corridor.....</i>	<i>49</i>
<i>I-90 Corridor.....</i>	<i>50</i>
<i>I-405 Corridor.....</i>	<i>50</i>
COMMUNITY TRANSIT AVI PROJECT.....	52

HOVTT (FCM) PROJECT .....	53
<i>Determination of Travel Speed</i> .....	54
<i>Limitation of Analysis Procedure</i> .....	54
<i>Interpretation of Data and Graphs</i> .....	54
HOVTT (FCM) DATA RESULTS .....	55
I-5 North .....	56
I-5 Downtown .....	57
I-5 South .....	57
SR 520 .....	58
I-90 .....	58
I-405 South .....	59
I-405 North .....	60
SR 167 .....	60
CONCLUSIONS AND RECOMMENDATIONS .....	61
<b>CHAPTER FIVE: PUBLIC OPINION SURVEY .....</b>	<b>65</b>
TRAVELER DEMOGRAPHICS .....	67
TRAVELER COMMUTE TRIP .....	73
TRAVELER OPINIONS .....	79
OPINIONS ON VARIOUS HOV LANE ISSUES .....	85
SUMMARY OF PUBLIC OPINION SURVEY RESULTS .....	92
<b>CHAPTER SIX: SECONDARY DATA SOURCES .....</b>	<b>93</b>
BUS RIDERSHIP ON HOV LANES .....	93
<i>Metro Transit Ridership</i> .....	93
<i>Community Transit Ridership</i> .....	96
<i>Pierce Transit Ridership</i> .....	98
ENFORCEMENT, COMPLIANCE, AND ADJUDICATION .....	99
<i>The HERO Program</i> .....	99
<i>Washington State Patrol</i> .....	101
<i>Adjudication Data</i> .....	101
ADJUDICATION DATA RECOMMENDATIONS .....	105
ACCIDENT INFORMATION .....	105
<i>Data Collection and Analysis</i> .....	106
ACCIDENT DATA CONCLUSIONS AND RECOMMENDATIONS .....	107
<b>CHAPTER SEVEN: CONCLUSIONS AND RECOMMENDATIONS .....</b>	<b>109</b>
AVERAGE VEHICLE OCCUPANCY CONCLUSIONS AND RECOMMENDATIONS .....	109
<i>Recommendations</i> .....	110
ACO ANALYSIS CONCLUSIONS .....	111
BASELINE TRAVEL TIME AND HOVTT (FCM) DATA CONCLUSIONS AND RECOMMENDATIONS .....	111
<i>Recommendations</i> .....	112
PUBLIC OPINION SURVEY CONCLUSIONS .....	114
<i>Recommendations</i> .....	114
ENFORCEMENT DATA CONCLUSIONS AND RECOMMENDATIONS .....	114
<i>Recommendations</i> .....	115
ACCIDENT DATA CONCLUSIONS AND RECOMMENDATIONS .....	115
<i>Recommendation</i> .....	116
<b>ACKNOWLEDGMENTS .....</b>	<b>117</b>
<b>REFERENCES .....</b>	<b>118</b>
<b>APPENDIX A .....</b>	<b>1</b>
ACO and Travel Time Observation Sites .....	1

<b>APPENDIX B</b> .....	<b>1</b>
ACO Data.....	1
<b>APPENDIX C</b> .....	<b>3</b>
Observer Comments Made During Vehicle Occupancy Sessions.....	3
<b>APPENDIX D</b> .....	<b>2</b>
ACO Data Analysis.....	2
<b>APPENDIX E</b> .....	<b>0</b>
Baseline Travel Time Data.....	0
<b>APPENDIX F</b> .....	<b>1</b>
HOVTT (fcm) Travel Time and Community Transit AVI Data .....	1
<b>APPENDIX G</b> .....	<b>2</b>
Speed Comparison Data - HOV vs. GP Lanes (HOVTT Data).....	2
<b>APPENDIX H</b> .....	<b>3</b>
Observer Comments Made During Travel Time Data Sessions.....	3
<b>APPENDIX I</b> .....	<b>6</b>
Sample Survey .....	6
<b>APPENDIX J</b> .....	<b>7</b>
Comments of Survey Respondents.....	7

# HOV LANE EVALUATION AND MONITORING

## ABSTRACT

This report updates the previous report with the same title dated August 1997 (WA-RD 414.2) and summarizes the data collected in fulfillment of the requirements for the Washington State Department of Transportation's contract HOV Lane Evaluation and Monitoring. This report provides the information necessary to analyze HOV lane performance and development. Data collection results and analysis are presented, followed by conclusions and recommendations.

The data contained herein were collected during various phases of the high occupancy vehicle lane (HOV) monitoring project (July 1992-June 1998). The data collection methodology is described in detail in the companion report, *HOV Monitoring and Evaluation Tool*. (1) Discussed in this report are the following primary and secondary measures of HOV lane performance: (1) vehicle occupancy data; (2) travel time data; (3) public opinion survey results; (4) transit ridership; and (5) enforcement, compliance, and adjudication data. Additional secondary measures such as transit load factors and HOV lane accident rates can be obtained by contacting Metro, Community, and Pierce Transits and the Washington State Patrol, respectively. Data collection issues and their implications for data availability are also covered.

It is important to note that this report does not evaluate the HOV lane system in the Puget Sound region. Rather, it is a compilation of the data necessary to conduct a meaningful evaluation. Although an analysis of public opinion and enforcement is provided, the report's primary purpose is to simply present the data and discuss issues associated with their use, not to provide an extensive analysis.



## **EXECUTIVE SUMMARY**

This is the fifth in a series of annual data reports for the High Occupancy Vehicle Lane (HOV) Monitoring and Evaluation project, sponsored by the Washington State Department of Transportation (WSDOT) and the Federal Highway Administration (FHWA). The purpose of this project is to collect data on the usage of the HOV lane system in the Puget Sound region and to make those data available to a wide audience of transportation planners and authorities. Completion of the HOV lane system is a high priority for WSDOT. However, it is useful to understand the strengths and weaknesses of the current HOV lane system before the significant costs of constructing new HOV lanes are incurred. The companion report, *HOV Monitoring and Evaluation Tool (1)*, describes the data collection methodology in detail and is supplemented with quarterly reports covering any changes to collection measures.

This report is not an evaluation of the HOV lane system in the Puget Sound region; rather, it is a compilation of the data necessary to conduct a meaningful evaluation. However, some of the data included in this report will need to be studied more closely before substantive recommendations on existing HOV lane policy can be made. Data are primarily presented in raw form; interpretation and relationships to other data are provided when appropriate. The key elements of this data collection effort are, (1) it gathers a wide range of information about the HOV lane system from throughout the Puget Sound region and (2) the collection effort is sustained over time. These elements will allow WSDOT planners to assess the changes in travel behavior that an HOV lane system is designed to induce, particularly where HOV lanes do not currently exist.

Analysis of the types of data outlined below will enable WSDOT to evaluate the performance of the HOV lane system in terms of the objectives described in the 1992 Washington State Freeway HOV System Policy report. HOV systems serve the following objectives:

- *Improve the capability of congested freeway corridors to move more people by increasing the number of people per vehicle.*
- *Provide travel time savings and a more reliable trip time to high occupancy vehicles that use the facilities.*
- *Provide safe travel options for high occupancy vehicles without unduly affecting the safety of freeway general-purpose mainlines.*

Measures of effectiveness used to determine the impact of the HOV system include the following:

- *person throughput*
- *vehicle occupancy*
- *comparative and absolute general-purpose (GP) and HOV lane travel times*
- *travel time reliability.*

Data collection since August 1996 has centered on both travel time savings and average car occupancy (ACO) analysis at the request of WSDOT. In general, the HOV system has performed as expected. Most problems have occurred in the commute direction along the start or terminus of a given HOV lane, at major freeway intersections, and through the central business districts (CBDs) within Puget Sound. Results of the AVO data are in Appendix B, with corridor descriptions given in Chapter 2. Results for the high occupancy vehicle travel time (HOVTT) data are in Appendix F and G, with corridor speed evaluations given in Chapter 4.

Overall, the support for HOV lanes continues to remain high among all commuters, but opinions of HOV drivers and SOV drivers are diverging on issues related to HOV lane usage, performance, and funding. Fortunately, the public's support is as strong as ever when it comes to continuing with construction of the HOV system, with 71 percent of survey respondents in favor of the idea. In response to what options may help

improve the current HOV system, the public supports issues related to expansion and enforcement over issues linked to transportation management such as employer subsidies, increased bus service, and more Park & Ride lots.

The period covered by this report was July 1992 through June 1998. The data were collected under the methodology developed for the HOV Monitoring and Evaluation Tool project, with changes in collection methodology noted in the supplemental quarterly reports. The collection of conventional travel time data was suspended as of July 1993, but it resumed in October 1995 utilizing the HOV Travel Time Floating Car Method [HOVTT (fcm)]. Violation information was provided by the HERO program (see Chapter 6), the Washington State Patrol Violation Recap Agency, and the Office of the Administrator for the Courts. Data on vehicle occupancy and travel time (two methods) are presented in Appendices B, E, F, and G. The ACO data and HOVTT data will be updated quarterly and made available via the Internet at <http://www.wsdot.wa.gov/eesc/atb/atb/hov/Titlepg.html>.

## **Recommendations**

The following recommendations are guidelines for the continued success of the project. Although they are presented here as brief statements, a further explanation of their importance is provided in Chapter 7 of this report.

1. Continue to prioritize observations at locations that ensure the best use of resources.
2. Evaluate the appropriateness of collecting vehicle occupancy data on the I-5 express lanes.
3. Use short travel time study sections.
4. Conduct more travel time data collection sessions per study section.
5. As a special study, conduct travel time observations of the express lanes.
6. Conduct periodic reviews of the survey to ensure the appropriateness of its content.
7. Conduct a special study of repeat offenders to shed some light on the extent to which violators change their behavior after receiving a ticket.
8. Conduct a special study on highway corridors characterized by chronic violation problems.
9. Index funding for data collection efforts with the opening of new HOV lane miles.

## **CHAPTER ONE: INTRODUCTION AND RESEARCH APPROACH**

### **PURPOSE AND PRODUCTS**

The purpose of this project is to provide a comprehensive set of data for the HOV lane system in the Puget Sound area. These data will be primarily used by transportation planners and authorities to evaluate the performance of the HOV lane system and to aid planning of other HOV facilities. This report is the fifth in a series of annual data reports that will allow parties to track changes in the performance of the HOV lane system over time. This report also contains recommendations for future HOV lane policy and evaluation efforts. Information concerning the data collection method is available in the companion report, *HOV Monitoring and Evaluation Tool (1)*. Periodic changes in methodology are noted in subsequent quarterly reports that are available locally.

### **MEASURES OF EFFECTIVENESS**

HOV lanes are intended to reduce average travel time and to increase travel time reliability for transit users, carpoolers, and other ridesharers. HOV lanes are supposed to provide a relatively unobstructed lane for users. For these reasons, HOV lanes are expected to encourage transit use. The expected reductions in both travel time and congestion must be measured to determine whether HOV lanes are cost effective. Vehicle occupancy, travel time, and public opinion are the three types of primary data collected by this project. Secondary sources are used to assess enforcement and violations along HOV lanes. Although traffic volumes and person throughput may be estimated from vehicle occupancy data, it is not the intent of this report to estimate these or any other categories, such as violation rates, as related to traffic flows. Traffic volumes are better measured using volume data from inductance loop detectors; person throughput can then be estimated by multiplying the volume data by occupancy data

percentages. Analysis of violation rates also depends on the availability of traffic volume data. Inductance loop data are not currently collected as a part of this project, but this information can be obtained by contacting WSDOT Northwest Region. The data collection efforts have focused on the following measures:

- **Vehicle Occupancy/Mode Choice.** Vehicle occupancy is recorded by human observers in the field at 53 sites in the Puget Sound area. Data are collected from HOV lanes, general purpose lanes, and access/egress ramps to provide a profile of commute patterns, congestion, and the average number of passengers traveling along commute routes during peak commute hours. Now that the project has a solid baseline of occupancy counts at a variety of site locations, observation sessions are scheduled exclusively at mainline sites within the Puget Sound region. Rather than average vehicle occupancy (AVO), average car occupancy (ACO) is derived from the data.

Determining AVO requires the use of transit and vanpool loading factors specific to the region under consideration (Chapter 2). Ridership information can be obtained from the three local transit agencies that operate routes on HOV lanes: Metro (King County Department of Metropolitan Services), Community Transit (Snohomish County), and Pierce Transit (Pierce County). These data should focus on changes in ridership over time for routes along freeway segments that contain HOV lanes.

Mode choice data can be derived from vehicle occupancy and are supplemented by survey results from this project. Subsequent sections of this report discuss data collection and the implications these methods have on the data available. A regression analysis of the baseline vehicle occupancy data was performed in 1993, and those results are discussed further in Chapter 2.

- **HOV Violations.** Violation rates may be calculated for peak-hour commute times by determining the number of single occupant vehicles (SOVs) that use the HOV lane. Data from ACO observations, the number of HOV violation tickets and warnings issued by the Washington State Patrol (WSP), adjudication results, and information from the HERO program indicate the frequency of HOV violations and the enforceability of current restrictions (see Chapter). Taken together, these sources provide information about reports from citizens on HOV violations on area highways, tickets and warnings issued primarily by law enforcement officers, and the number of paid tickets and the outcomes of contested tickets in the courts. Survey results provide information about regional commuters' perceptions of violations.
- **Safety.** Public opinion survey results provide information about commuter perceptions of HOV lane safety. These data measure the level of concern about safety and its impact on mode choice.
- **Travel Time.** Travel time data measure the effectiveness of HOV lanes at reducing commute times and improving reliability. Originally, a license plate matching method was used to measure and compare travel times on HOV lanes and general purpose lanes. Multiple counts at specific sites and roadway segments measured the travel time reliability function of HOV lanes and estimated the speed and flow of traffic. Over time, renewed observations may be used to measure the absolute and relative travel time savings for HOV lanes. Because of the demands on resources this method exacts and the level of labor required to produce significant samples, a different method of a data collection was adopted in October 1995: the Floating Car Method (fcm). Observers collect actual travel time data during the commute period by measuring the time differentials between given roadside landmarks. This method is further described in Chapter 4.

- **Public Opinion.** Public opinion data indicate the HOV program's perceived importance and effectiveness, as well as ways it may be modified to appeal to more of the region's drivers. Public opinion is measured by analyzing survey results from randomly selected commuters observed along freeway routes that contain HOV lanes during peak commute periods. Mail-out surveys were sent to drivers of both HOV and SOV vehicles identified in the field by traffic observers. The mail-out surveys were designed to elicit area drivers' perceptions of the attractiveness, efficacy, safety, and violations of HOV lanes. This report presents public opinion data to show overall results and to determine differences in opinion between ridesharers and SOV commuters.

These measures of effectiveness categories provide a valid basis for evaluating the performance of the current HOV lane system. They also help address WSDOT's information needs for determining where and when to construct new HOV facilities.

WSDOT's *HOV Lane Minimum Threshold Policy* states four preconditions for HOV lane construction:

1. facility demand exceeds capacity for more than one hour each day
2. evidence exists that an HOV lane will move more people per hour during peak periods than the per-lane average of the adjacent general purpose lanes
3. there is local support for HOV lane construction
4. The HOV lane segment will improve continuity by linking other HOV lane corridors identified in the *Year 2000 HOV Core Lane System (3)*.

The ACO and public perception data available from this study will provide WSDOT with some of the information necessary to evaluate minimum threshold requirements for new HOV lane construction. These data will also be useful in decisions



concerning lane configuration, occupancy requirement policies, and general purpose lane conversion.

The data published in this report will be readily available to WSDOT officials and planners, as well as to other interested jurisdictions. Analysis of much of the data requires specialized computer programs designed for this project, in addition to the Statistical Package for Social Sciences for Windows (SPSSWIN) statistical analysis program.

### **DATA COLLECTION**

As stated before, extensive documentation of the data collection method used for this project is provided in the companion report *HOV Monitoring and Evaluation Tool* (1) and in supplemental quarterly reports. However, a brief explanation of the data collection process is in order.

This study employs human observers to collect data pertaining to vehicle occupancy and travel time, as well as the information necessary to send out public opinion surveys. Traffic observers count the occupants in each vehicle in a given lane as the vehicle passes beneath a highway overpass or through an access ramp. Travel time data have been collected by matching license plate numbers with unique time indices at two points along a roadway. Current travel times are collected by means of the Floating Car Method. Observers drive the HOV lanes (and sometimes the general purpose lanes) during the commute period and measure the time differential between given roadside landmarks. Observers also collect license plate numbers of both HOVs and SOVs to generate comparable samples for the public opinion survey. These observers enter data onto personal computers (observers originally used Toshiba T1000 laptops but now use smaller, more reliable Hewlett-Packard HP-95 palmtop computers) and hard-copy forms when necessary. Data are collected on the major interstate and state highways in the region: I-5, I-90, I-405, SR 520, SR 16, SR 167, SR 410, and SR 512 between the peak

commute hours of 6:00 AM to 9:00 AM, and 3:00 PM to 6:00 PM (three hours each). State highways 16, 167, 410, and 512 were added to this list in the third quarter of 1993, but SR 167 is the only one of these routes currently under observation. No data regarding express lane traffic on the I-5 north and I-5 downtown corridors have been collected, but AVO data on the reversible lanes of I-90 have been available since the third quarter of 1994. At the same time, for ease of data management and to increase the number of data collection sites, the I-405 corridor was divided into three corridors: I-405 South, I-405 Central, and I-405 North (1). Observation sites were also added to I-5 in Everett and Tacoma. ACO data from July 1995 to the present are available for all mainline sites. Table 1.1 indicates the type of data collected, the data collection quarters, and their corresponding dates for this study. (See Table A1 for the beginning dates of study for the data collection sites.)

**Table 1.1: Data Collection Period, by Quarter**

<b>Type</b>	<b>Quarter of Study</b>	<b>Dates</b>
AVO	Q3/92	July 3, 1992 - October 2, 1992
AVO	Q4/92	October 5, 1992 - January 1, 1993
AVO	Q1/93	January 4, 1993 - April 2, 1993
AVO	Q2/93	April 5, 1993 - July 2, 1993
AVO	Q3/93	July 5, 1993 - October 1, 1993
AVO	Q4/93	October 4, 1993 - December 31, 1993
AVO	Q1/94	January 3, 1994 - April 1, 1994
AVO	Q2/94	April 4, 1994 - July 1, 1994
AVO	Q3/94	July 5, 1994 - September 30, 1994
AVO	Q4/94	October 3, 1994 - December 30, 1994
AVO	Q1/95	January 2, 1995 - March 31, 1995
AVO	Q2/95	April 3, 1995 - June 30, 1995
AVO	Q3/95	July 3, 1995 - September 29, 1995
HOVTT	Q4/95	October 2, 1995 - December 29, 1995
HOVTT	Q1/96	January 3, 1996 - March 29, 1996
HOVTT	Q2/96	April 1, 1996 - June 28, 1996
AVO	Q3/96	July 1, 1996 - September 27, 1996
HOVTT	Q4/96	September 30, 1996 - December 27, 1996
HOVTT	Q1/97	January 1, 1997 - March 28, 1997
AVO	Q2/97	March 31, 1997 - June 30, 1997
AVO	Q3/97	July 1, 1997 - September 26, 1997
HOVTT	Q4/97	September 29, 1997 - December 27, 1997
HOVTT	Q1/98	January 2, 1998 - March 27, 1998
AVO	Q2/98	March 30, 1998 - June 26, 1998

The type of observation performed and the collection method used affect the success of occupancy and travel time data collection. The objective is to conduct as many observations for a wide distribution of sites, with a goal of ten half-hour counts per type of lane (GP vs. HOV) per quarter per site for ACO data collection. To make the best use of resources, data collection has focused on the direction in which peak period traffic is expected to flow. The type of data being gathered, the number of observers, logistical considerations, and the success of previous observations affect scheduling. Data collection is further affected by such factors such as the site's geographic characteristics, weather and light conditions, observer performance, and data quality management.

The occupancy and travel time data presented in this report are from 59 sites studied during the first three phases of data collection (38 sites are for occupancy, 8 are for travel time data collection, and 13 are used for both). Only ACO data and data using the floating car method [HOVTT (fcm)] are now being collected. Baseline travel time data collection using the license plate method was discontinued as of July 1993 (1).

### **REPORT ORGANIZATION**

Chapter 2 discusses vehicle occupancy data. Chapter 3 analyzes these ACO data. Chapter 4 discusses travel time data. Chapter 5 provides comprehensive information from the public opinion survey. Secondary data sources pertaining to enforcement, compliance, and adjudication are presented in Chapter 6 with project conclusions and recommendations contained in Chapter 7. The appendices contain vehicle occupancy and travel time data, as well as relevant supplemental information.

## CHAPTER TWO: BASELINE VEHICLE OCCUPANCY DATA

Vehicle occupancy data are an empirical measure of commuter mode choice. This measure can also be used to evaluate the effect of HOV lanes on the person-carrying capacity of commute corridors. Vehicle occupancy data indicate the proportion of vehicles of a certain occupancy or mode at a given freeway location during the weekday peak commute. For the project's ongoing collection, observers record the vehicle occupancy and mode at mainline and ramp locations by using a program that time-stamps each observation. Average car occupancy (ACO) is then calculated from these observations with the formula shown in Figure 2.1. Note that only passenger vehicles are considered in the calculation of this number. To calculate average vehicle occupancy (AVO), the formula in Figure 2.2 is recommended, but with reservations. The weighting factors of 10 and 40 occupants (for vanpools and public transit buses, respectively) vary by site, time of day, direction of travel, and quarter, and are likely to overestimate AVO. For this reason, ACO, rather than AVO, is used in the remainder of this report. AVO can only be estimated after the average vanpool and bus loadings for each location have been acquired from the appropriate transit agencies.

Average car occupancy (ACO) can be calculated using the following formula:

$$ACO = \frac{(1 \times SOV) + (2 \times DOV) + (3 \times TOV) + (4.1 \times FOV)}{SOV + DOV + TOV + FOV}$$

where

- **SOV** is the number of single-occupancy vehicles observed
- **DOV** is the number of double-occupancy vehicles observed
- **TOV** is the number of triple-occupancy vehicles observed
- **FOV** is the number of vehicles observed with four or more occupants.

Note: Vanpools, buses, other transit vehicles, motorcycles, and tractor semi-trailers are not considered.

**Figure 2.1: Calculation of Average Car Occupancy**

Average vehicle occupancy (AVO) can be calculated using the following formula:

$$AVO = \frac{(1 \times SOV) + (2 \times DOV) + (3 \times TOV) + (4.1 \times FOV) + (10 \times VAN) + (40 \times PT)}{SOV + DOV + TOV + FOV + VAN + PT}$$

where

- **SOV** is the number of single-occupancy vehicles observed
- **DOV** is the number of double-occupancy vehicles observed
- **TOV** is the number of triple-occupancy vehicles observed
- **FOV** is the number of vehicles observed with four or more occupants
- **VAN** is the number of vanpools
- **PT** is the number of public transit buses.

Note: Other transit vehicles, motorcycles, and tractor semi-trailers are not considered.

**Figure 2.2: Calculation of Average Vehicle Occupancy**

Occupancy data in this report are presented in Appendix B according to the following characteristics:

- corridor of study
- observation site
- AM or PM peak period
- traffic flow direction
- mainline (GP or HOV) or access/egress ramp location.

Data indicate the number of vehicles that were observed by type of occupancy, the total number of vehicles, the ACO, and the number of counts successfully conducted for each quarter of the study. Data about mainline locations include the number of lanes so that the average counts per lane can be estimated for comparing general purpose (GP) lanes with HOV lane data. The figures in these tables are work-week and commute period aggregates (thereby assuming that the daily ACO does not vary significantly).

Although the data may be disaggregated by day of the week, by hour of commute, or by lane of traffic if desired, at some locations a sufficient number of observation

sessions may not have been completed to make this possible. Occupancy data may also be aggregated to determine the overall ACO for the following:

- multiple sites of a corridor
- combined GP and HOV lanes
- all access/egress ramps
- simultaneous directions of traffic flow (within the limits of the data and aggregation program).

Because loop inductance data gathered from these sites are more representative of corridor traffic volumes, the data presented herein should only be used to generate estimates of the distribution of vehicle mode and occupancy (e.g., proportions of SOVs). Occupancy data presented in this report should not be used to compute traffic volumes.

During Phase I of this project, vehicle occupancy data were collected from 41 sites. Each had either mainline or access ramp locations, or a combination thereof, amounting to 14 mainline and 26 access/egress ramp locations. During Phase II, data collection was expanded to include sites in Tacoma, Everett, and Issaquah for a total of 53 sites with 10 new mainline and two access/egress ramp locations. ACO data collection during Phase III was severely limited because of budget constraints, with the number of sites reduced by roughly a third. The data, shown in Appendix B, are available beginning with the third quarter of 1992 and ending with the second quarter of 1998 (see Table 1.1 for the quarters and their calendar equivalents). In Appendix B, the data for each site are preceded by a diagram denoting the locations of sites within a given corridor, followed by a lane diagram of the site that indicates the traffic flow direction and type (mainline or ramp). Comments made by observers while they were collecting occupancy data can be found in Appendix C. These comments pertain to the weather and traffic conditions in which the data were collected.

## **OCCUPANCY DATA AVAILABILITY**

A minimum of ten 30-minute counts per type of lane per quarter per site for each peak commute period are necessary to provide statistically significant data (2). Under optimum conditions, five to six counts are conducted per 3-hour session. Although collection was designed with this requirement in mind, the significance of results is affected by the availability of the data collected, as well as by the variation of each site's peak period. The availability of data for these sites depends on the number of observation sessions scheduled and on the number of counts successfully performed for a given quarter. (For a description of factors likely to render data unusable, please refer to *HOV Monitoring and Evaluation Tool*.) These conditions are affected, in turn, by a number of factors, including the direction of traffic flow, the weather, geographic characteristics of the site location, and the success of scheduling efforts. Because of the large number of locations involved, counts have been prioritized in favor of sites that are expected to capture more typical traffic patterns. Additional locations have been scouted and scheduled as the project has progressed. Scheduling is also affected by the availability of transportation for observers.

Because of these variables, data for some tables are incomplete. In the majority of cases in which data are insufficient, it is because no counts had been scheduled during that time. In other cases, only one or two counts were completed, and the available data files were not usable (see *HOV Monitoring and Evaluation Tool* for a discussion of causes (1)). In addition, data may be unavailable for specific lanes of traffic at certain mainline locations because the number of lanes exceed the number of counts conducted at those sites.

### **Scheduling**

Determining which sites to use is a process that has developed over time, partially as a result of learning which locations are better for observations, as well in response to



WSDOT requests for new information. During the first two quarters of data collection, emphasis was placed on scheduling observations according to expected commute patterns: e.g., inbound Seattle central business district (CBD) traffic during the morning commute and outbound traffic during the evening commute. In areas where this pattern was less clear, such as the CBD traffic on the downtown I-5 corridor and the suburb-to-suburb traffic on the I-405 corridor, collection efforts were expanded to include less obvious reverse traffic flows as well. Although most sites had been identified by the summer of 1992, months of observation were needed to discern these counter-traffic patterns and to schedule observations accordingly. Scheduling success is also affected by whether student observers have transportation; because more than one observer typically relies on a single vehicle, if that vehicle is not available, the counts for the affected observers are canceled. Whenever possible, canceled observations are rescheduled.

### Visibility

The ability to see into passing vehicles--and thus to observe the number of occupants accurately--is affected by the positions of the observer, the traffic, and the light source (1). Because visibility can be greatly affected by weather conditions, the usefulness of sites typically remains unknown until the weather and light conditions change. Overpasses are generally undesirable because the farther away an observer sits from traffic, the more difficult it is to see into passing vehicles. However, overpasses do provide the best combination of visibility and safety in comparison to street level sites, which do not allow observers to see all lanes of traffic. As weather and light availability changes, a site on an overpass that provides a good view into the interiors of vehicles in the summer may become useless in the winter because streetlights are absent or provide insufficient light to see into passing vehicles. Under such circumstances, data collection may be limited to daylight hours. The result is that, for a number of locations, data during the fall and winter quarters (e.g., Q4/92 and Q1/93, respectively) are not available.

Darkness during the winter months has forced morning counts to begin after 7:30 AM and evening counts to end before 5:00 PM--an hour to an hour-and-a-half later (or earlier) than scheduled. Therefore, instead of the expected five to six counts per session, only three to four counts per session may have been successfully performed during the fall and winter quarters, if at all. Now that baseline data collection for most of the data sites has been completed, ACO observation will be conducted during the lighter spring and summer months, whereas HOVTT data will be collected during the darker fall and winter months. Another issue that affects observer performance is whether traffic is approaching or going away from observers. (4)

### **Mainline Observations**

Mainline data include both HOV and GP observations; these are collected by observing a different lane for each 30-minute count. Ramp data are collected by observing the same ramp throughout the session. The number of lanes at each mainline location is shown in the site diagram and displayed under the location heading ("GP lanes" or "HOV lanes") (see Appendix B). Although the observers collect data separately for each individual lane, the analysis program distinguishes only between HOV and GP lanes (thereby combining the data for individual GP lanes). As a result, the number of counts performed for GP lanes effectively outnumbers those for HOV lanes, which makes a direct comparison between the two types of lanes difficult.

In an effort to make the samples of HOV and GP lanes more comparable, a type of rotation counting was adopted in the fourth quarter of 1994. Observers now begin their sessions with the HOV lane, proceed to a GP lane for their second count, and then return to observing the HOV lane for their next count. By repeating this order, sample sizes of HOV and GP lanes will be fairly uniform for each quarter. For ACO data collected before Q4/94, the number of HOV and GP lanes must be taken into consideration to compare HOV lane with GP lane observations. This can be done by

dividing the number of quarterly counts by the number of each type of lane to obtain the average number of counts per lane.

Data availability for mainline locations is affected by a number of factors. Although mainline data are preferable to data collected at access/egress ramps, they are more difficult to obtain. They require the use of overpasses, which are more difficult to locate because overpasses occur less frequently than access/egress ramps, and those with characteristics favorable for observing vehicles (such as adequate lighting and lower height (1)) are even rarer. In the past, observations were scheduled to obtain mainline data from at least one overpass per corridor and access ramp data were collected to supplement the data during the winter months. As a result, data tend to be more readily available from ramp locations during the winter months. Currently, ACO observations are suspended between October and April each year in favor of HOVTT travel time data collection.

Data also may be unavailable for individual lanes of certain mainline locations because the number of lanes is greater than the number of possible counts per session. During a three-hour session, observers are able to conduct up to six half-hour counts. When observers are faced with more lanes of traffic than the conditions of the session allow, at least one lane may be missed for any given session; during the fall and winter quarters, this number rises to include at least two lanes. This limitation has been counteracted by specifying the lane at which a session is to begin and then rotating the order of the lanes so that each lane will be observed at least once per quarter.

### **Ramp Observations**

There are almost twice as many ramp sites as there are mainline sites. Because access/egress ramps are more numerous and typically have better lighting than overpasses, they were ideal locations for observing vehicle occupancy. An important feature of access/egress ramps (particularly on-ramps) is that data were likely to vary

greatly. This is due to the lower volume of vehicles they carry, which means that there was a greater chance for random variation. Ramp locations were therefore studied to supplement mainline data, as well as to determine whether some of their data could be used as "proxies" for data gathered on the mainlines. A result is that some locations were only counted during the winter months. Both on- and off-ramps were used. In places where ramps had metered GP and HOV bypass lanes, vehicles were recorded regardless of the lane, thereby combining the data for these locations. Ramp observations were discontinued at the end of the second quarter of 1995 because of budget cuts, and no plans to renew collection efforts are under consideration.

## **AVERAGE CAR OCCUPANCY SITES**

### **I-5 North Corridor**

The I-5 North corridor is 9.4 kilometers long, beginning at NE Northgate Way (north of SR 520) and continuing to 236th Street SW. Four evenly spaced sites have been used with well-lighted locations: 236th Avenue SW, N 175th Street, N 145th Street, and NE Northgate Way. For all sites, morning southbound and evening northbound traffic has been measured from on- and off- ramp locations, respectively. Of these, only N 145th Street has been used for mainline data collection. Data are unavailable for 236th Street SW for the AM northbound flows during the second quarter of 1993 (Q2/93) and for the PM southbound flows during the third and fourth quarters of 1993. No data have been collected for 236th Street SW, N 175th Street, or any ramp observation sites since Q2/95.

### **I-5 Downtown Corridor**

This corridor begins at S 144th Street and ends at Roanoke Street, a distance of 18.9 kilometers, including I-90 and ending at the I-5/SR 520 interchange. Conducting observations in this corridor has been difficult because both directions of traffic have to be examined for each commute period (there is no obvious directional flow). Additionally, because of the irregular layout of the access/egress ramps, it is impossible to conduct observations in the same manner as is possible at suburban locations with traditional cloverleaf or diamond patterns. Because no single set of locations can satisfy collection requirements, a greater number of sites have to be used. Six ACO sites-- Lakeview Boulevard E , Roanoke Street, S Holgate Street, Albro Place, Madison Street, and S 144th Street--have been used for mainline observations. Eight sites--Lakeview Boulevard E, Corson Avenue S, Stewart Street, S Michigan Street, Olive Street, Madison Street, and Howell/Yale Sts.--have been used for ramp data collection.

The majority of observations have been conducted around three clusters of ramps: one set north of the downtown central business district (CBD), a second set at the CBD, and third set south of the CBD. *North of the CBD*, observations were conducted at Lakeview Boulevard E, but the site was then replaced by Roanoke Street (which was found to be better because it was closer to street level) during the first quarter of 1993 (Q1/93). However, observations at Roanoke were discontinued Q3/95.

*Within the CBD*, locations at Olive Way (northbound, evening on-ramp) and Howell/Yale Sts. (southbound, evening on-ramp) have provided for "outbound" traffic; Madison (northbound, morning off-ramp) and Stewart Street (southbound, morning off-ramp) have provided for "inbound" traffic data. Morning counts at Olive Street and Howell/Yale Sts., northbound, did not begin until later in 1992. Mainline data collection at Madison Street was a special study begun at the request of WSDOT District 1 during the Q2/93. Ramp data collection began in the fourth quarter of 1992 (Q4/92) for AM counts and in the fourth quarter of 1993 (Q4/93) for PM counts. Stewart Street was not added until Q4/92 for AM counts and until Q4/93 for PM counts. Data are unavailable for Olive Way AM counts during Q3/93, Howell/Yale Sts. counts AM during Q3/93, and Madison AM counts during Q4/93 because observations were not scheduled. Currently no observations are being conducted along this section of I-5 within the CBD.

*South of the CBD*, counting at S Holgate Street was changed to counting at Albro Place because of the unfavorable characteristics of the site. (There was a sidewalk on only one side of the overpass, and at the time, the HOV lane ended about 200 yards before the overpass, making it difficult to determine vehicle occupancies in that lane.) Observations were suspended at the following sites: S Holgate Street and Corson Avenue S, beginning Q1/93, S Michigan Street, beginning Q2/93, and mainline evening counts at S 144th. St., beginning Q1/93. Site #25 (Albro Place) is the only location where ACO data have been collected along this corridor since Q2/95.

### **I-5 South Corridor**

The corridor begins south of the I-405 interchange, at S 188th Street, and continues south to S 272nd Street, for a distance of 8.9 kilometers. Data collected during the morning commutes have been for northbound traffic (on-ramps only); afternoon data have been collected from only southbound traffic (off-ramps only). Of the seven occupancy collection sites, one (S 216th Street) has been used exclusively for mainline observations; the remainder (S 188th Street, S 200th Street, SR 516--Kent/DesMoines Road, SR 516--Kent ramp, SR 516--DesMoines ramp, and S 272nd Street) have been used to collect ramp data. The ramp locations at SR 516 have been treated as if they were three different sites.

An instance of observations missing where sessions were conducted is the HOV lane of S 216th Street in the morning northbound lanes (Q4/92). The data from the two counts completed for that lane were found to be unusable. No observations were scheduled at the SR 516--DesMoines on-ramp AM northbound for Q2/93, the S 188th St. off-ramp PM southbound for Q2/94, and the S 272nd St. on-ramp AM northbound for Q1/94 and off-ramp PM southbound for Q4/93. Site #34 (S. 216th St.) is the only location where ACO data have been collected along this corridor since Q2/95.

### **SR 520 Corridor**

This corridor is 7.9 kilometers long from the Hunt's Point pedestrian bridge to the 148th Avenue overpass. Of seven ACO sites, two have been used exclusively for mainline observations (Yarrow Point and 148th Avenue); the rest have been used for ramp data collection (Hunt's Point, SR 908, 124th Avenue, and 148th Avenue--Bellevue and 148th Avenue--Redmond ramps). These sites are all located east of Lake Washington; to date, data have not been collected on the Seattle side of the lake. Like SR 516 on the I-5 South corridor, 148th Avenue NE has been treated as if it were three

separate sites. Data have been collected for morning westbound (on-ramps) and evening eastbound (off-ramps) traffic only.

Data collected for this corridor were not usable or available for the following locations: the Hunt's Point on-ramp AM westbound for Q4/92 and Q2/93; the 124th Avenue NE on-ramp AM westbound for Q1/93 and off-ramp PM eastbound for Q2/93; 148th Avenue NE mainline AM westbound for Q4/92 and eastbound for Q1/93; and the 148th Avenue -Redmond ramp, Q1/93. Sites #42 (Yarrow Point) and #45 (148<sup>th</sup> Avenue NE) have been the only active locations along this corridor since Q2/95. In Q2/97, counterflow observations were started at the Yarrow Point site.

### **I-90 Corridor**

This corridor spans Lake Washington from 23rd Avenue S in Seattle to Front St. in Issaquah (between I-5 and SR 18), for a total of 23 kilometers. This corridor consists of nine ACO sites. Island Crest Way and Newport Way have been used for both mainline and ramp observations, whereas 60th Avenue SE, E Mercer Way, Bellevue Way SE, and Front St. have been ramp sites only. The site along the I-90 reversible lanes was added in Q3/94 for mainline ACO data, but data collection were not conducted between Q4/95 and Q2/97. Sites at 142nd Avenue and SR 900 were only considered during the initial testing period and have not been used since that time.

Island Crest Way was reported to be a poor vantage point in the mornings because of water sprinklers, landscaping, and the elevation of the overpass (4). Morning counts at this location were temporarily postponed during Q4/92 and Q1/93 because of the freeway landscaping project that was under way (which turned the location into a "sea of mud" following rain storms (4)). Data collected at the Island Crest Way on-ramp were not usable for Q1/93.

Observations at the E Mercer Way on-ramp were not scheduled for Q2/93 and Q3/93; observations at the off-ramp were not begun until Q1/93 because of construction;



and data for Q3/93 were not useable or were absent. Again, observations were scheduled for morning westbound traffic and evening eastbound traffic only. Observations were suspended in Q4/94 to free up resources for renewed observation at the Front St. site. Data for Bellevue Way are not available for the afternoon off-ramp eastbound site for Q3/93. Newport Way and Front Street in Issaquah were added during the third quarter of 1993 (Q3/93), and those data are included in this report with the exception of the following: Newport Way ACO data for Q4/93 and Front St. ramp ACO data between Q4/93 and Q3/94. ACO data are available for mainline sites at Newport Way (#57) and Island Crest Way (#54) only since Q2/97. In Q2/97, counterflow observations were started at the Island Crest Way site.

### **I-405 Corridor**

This corridor is unique in a number of ways. Before it was partitioned for data collection in the third quarter of 1993, it stretched from Tukwila Parkway (at Southcenter) to SR 908 (north of SR 520, by Kirkland) for a total of 27.9 kilometers, and it had more sites than any other corridor (except the I-5 Downtown corridor, which has nine sites). Morning and evening data on both northbound and southbound traffic were collected within along this corridor since it contains a number of "activity zones". Although a large amount of data were obtained, there were so many locations that observations were not performed as often as desired. As a result, bad data affected a larger proportion of the observation quarters. To improve collection efforts, and in anticipation of more sites along this corridor, I-405 was divided into three sections, as described below.

### **I-405 South Corridor**

This section begins at Tukwila Parkway and ends at 112th Avenue SE (Lake Washington Boulevard), for a total of 13.7 kilometers. It is the most complex section

because it runs through the suburban centers of Tukwila (where it merges with I-5), Renton, and Bellevue. Traffic here flows in multiple directions, traveling to and from both I-5 and I-90 towards Seattle, Tukwila, Renton, and Bellevue in the morning and returning in the evening. Although there are only four sites in this corridor, observations have been conducted to measure both morning northbound and southbound, and evening southbound and northbound traffic (similar to the I-5 Downtown corridor). Two sites (Tukwila Parkway and 112th Avenue SE) have been used solely for mainline observations during the period covered in this report. Three sites (SR 167, S Park Dr. and 112th Avenue SE) have been used for ramp data collection (as of Q2/93, ramp data collection from 112th Avenue SE was suspended). All ramp observations were discontinued as of Q3/95.

Data collected at Tukwila Parkway are unavailable for the morning northbound commute of Q3/92, and for the evening northbound commute between Q3/92 and Q1/93 because of bad data and the low number of counts performed. Counter-flow traffic data (morning southbound and evening northbound) were not collected during the winter months because of generally poor visibility and because they were not a high priority.

Ramp data for SR 167 were unusable for the evening northbound commute of Q4/92. For all other quarters in which data are missing, the reason is that counts were not scheduled. This ramp is not a healthy counting location because vehicle exhaust tends to accumulate here.

S Park Drive provides access to the Renton Boeing Plant, and so traffic patterns tend to be different here; peak periods run from 6:00-7:30 AM and from 2:00-4:00 PM; traffic is gone by 5:00 PM (4). Data for the northbound on-ramp traffic were not usable for the morning commute during Q4/92 and Q1/93 or for the evening commute during Q3/92 and Q4/92. Nor were they usable for the evening southbound commute during Q3/92 and Q4/92. During the period covered by this study, ramp improvement construction occurred at S Park Drive, which may have restricted the number of counts.

Data collection at all S Park Drive ramp sites was suspended in Q3/95. The reason that data are missing from any other quarters is that no sessions were scheduled.

At 112th Avenue SE, Q4/92 data were not usable for the GP lanes during the morning northbound commute and data were not usable for either the GP or HOV lanes of the morning southbound commute during Q3/92 to Q4/92. Both the evening northbound and morning southbound locations were counter-flow commutes, and thus observations were not begun until 1993. At all other locations for which data are absent, observations were not scheduled.

### **I-405 Central Corridor**

This 2.2-kilometer section of I-405 centers around downtown Bellevue from SE 8th Street to NE 12th Street, between I-90 and SR 520. With the completion of a new outside HOV lane, observations at this site were relocated to NE 4th, which provides a better viewpoint. Of the two active ACO sites, NE 4th Street has been used for mainline observations, and ramp observations have been conducted at SE 8th Street.

Data for SE 8th Street were not usable for the northbound commute of Q3/92 or for the morning on-ramp commute during Q4/92 to Q2/93. Traffic for the morning southbound commute was so light (as demonstrated by Q3/92 data) that on-ramp observations here were discontinued until Q3/93. At all other locations for which data are absent, observations were not scheduled.

Observations at NE 8th Street were abandoned after a few trial counts during the third quarter of 1992, although additional counts were performed during the first quarter of 1993. NE 8th Street was a poor site for observations because the northbound on-ramp was too far away, and the traffic there moved too fast for observers to determine occupancy reliably. Although the southbound off-ramp was well-lighted, two lanes of traffic exited at the same time and moved too fast to count (4).

During the winter months, it was generally too dark to see the number of occupants when mainline observations were conducted at NE 12th Street because the lighting was inadequate (4). Morning northbound and southbound commutes were not scheduled until Q2/93; data collected for the evening northbound commute during the two counts of Q1/93 were not usable. Data collection since Q2/97 was conducted at site #73b (NE 4<sup>th</sup> Street).

### **I-405 North Corridor**

Historically, only one site was observed along this corridor at the SR 908 interchange, 6.4 kilometers north of NE 12th Street. Mainline counts did not begin until Q3/93 and both ramp and mainline counts have been primarily conducted from the pedestrian bridge located here. Winter observations are difficult at the overpass because of poor lighting on the pedestrian bridge; better-lighted ramp locations at this site (such as the southbound on-ramp, which does not have a Jersey barrier) are not safe for observations (4). No observations were scheduled for the AM southbound on-ramp commute during Q2/93 and Q4/93 or for the PM northbound off-ramp commute during Q2/94. Between Q2/95 and Q4/95, a new outside HOV lane was added to the northbound and southbound freeway lanes. A new site at NE 160th St. (Juanita-Woodinville Way) was added during Q2/98 in response to WSDOT's request for additional HOV performance data along the northern sections of this corridor.

### **Outlying Locations**

Starting in the third quarter of 1993, several new observation sites outside the original corridors were added to the scheduling log. These sites were chosen to provide baseline data for the areas surrounding Tacoma, Everett, Kent/Auburn, and Issaquah.

These sites are

- North I-5 at 112th SE in Everett (SB and NB, AM and PM) (Observations at this site were suspended between Q4/95 and Q1/98 because of budget constraints.)
- South I-5 at 70th E in Fife (SB and NB, AM and PM)
- South I-5 at the Tacoma Mall (SB and NB, AM and PM) (Data for Q3/93 are absent because of problems with the quality.)
- SR 16 at the Narrows Bridge in Tacoma (WB and EB, AM and PM)
- SR 410 at East Valley Avenue in Sumner (WB and EB, AM and PM)
- SR 512 at Ainsworth Ave./ Steele in Parkland (WB and EB, AM and PM)
- SR 167 at 37th NW in Auburn (SB and NB, AM and PM) (Observations were not scheduled until Q4/93 for AM SB and NB, and PM NB.)
- SR 167 at S 208th in Kent (SB and NB, AM and PM) (Data sessions were not scheduled for the following: PM NB in Q3/93, AM SB in Q4/93, and PM SB between Q3/93 and Q4/93.)

Only mainline ACO data have been collected at these sites.

### **CONCLUSIONS AND RECOMMENDATIONS**

Occupancy data have been successfully collected from most of the study sites. Where data are unavailable, it is because an insufficient number of counts were scheduled or successfully completed. This happened for a number of reasons, including inclement weather, poor visibility, more sites than observers, and the discontinuation of data collection at some sites. The impact of having too few successful counts per quarter was that when bad data rendered the counts unusable, data for the entire quarter were possibly lost. During the first two years of the project, observation sessions were consistently more numerous for ramp than for mainline locations. This was because of the greater number of ramp locations and the better visibility they offered. There were also

proportionally more successful observations for GP lanes as a whole than for HOV lanes as a whole. This situation was corrected during the fourth quarter of 1994 with the adoption of a new counting procedure that involved rotating the lane to be observed between HOV and GP lanes. This procedure will provide sample sizes that are more comparable and enhance the validity of any comparison between HOV and GP lanes. However, in the third quarter of 1995, the total number of observations was reduced to ten count sessions per week because of a reduction in the funds allocated to the project. Funding for the '97-'99 biennium is sufficient enough to restore observations to the project's mainline observation areas with the option of including new or previously deactivated sites. At present, only mainline counts are being scheduled.

Factors not directly explored in this chapter include observer performance, and observer and data management; these are treated in greater detail elsewhere (1). Because observers are unsupervised in the field, they are trusted to begin and end observations on time and to observe and record vehicle occupancies accurately. Data quality is verified by checking individual files for "gross errors", such as misnamed files and repeated entries, and verified statistically by comparing current site data with site data collected from previous observations (see *HOV Monitoring and Evaluation Tool* (1)). As this project progresses, data will become increasingly accurate because of this method and will result in the emergence of a stable average as the volume of data increases. With this in mind, the following changes are recommended:

1. Continue to prioritize observations at locations that ensure the best use of resources. Safe locations that provide the best visibility over varying conditions, as well as ease of access and scheduling, are obviously preferred. Therefore, a directory of sites that includes site diagrams and a matrix of characteristics that affect data collection should be maintained. The question of whether counter-flow traffic patterns should be continued

or eliminated at existing locations, or expanded at additional locations, should be explored, as well as whether to maintain ramp data collection.

2. Evaluate the appropriateness of collecting vehicle occupancy data on the I-5 express lanes. Because express lanes contain both HOV and GP lanes, "before" data for this corridor may be useful in areas where express lane expansion is planned and would allow planners to monitor the express lanes' performance.

The occupancy data presented in this report provide valuable information in two areas: (1) the operation and performance of HOV lanes in comparison to GP lanes and (2) commuter mode choice in the greater Seattle area. Additionally, as the HOV lane system expands, areas where "before" data are now being collected will serve as baseline reference points in assessing the impact of HOV facilities on commuter mode choice. However, a caveat is in order: because loop data are more representative of traffic volumes in these corridors, the data included in this report should be used only to indicate the percentages of mode and vehicle occupancy in the corridors studied. The following chapter, "Average Car Occupancy Data Analysis," provides a treatment of these raw data and potential sampling bias.

## CHAPTER THREE: AVERAGE CAR OCCUPANCY DATA ANALYSIS

The average car occupancy (ACO) data presented in this report are raw numbers. They are based on actual observations conducted between July 1992 and June 1998; they are not corrected for sample bias. The process for sampling time of the year, day of the week, time of day, lanes (or ramps), and locations, was designed to provide overall ACO figures that can be compared from year to year. The sample size is large enough that statistical variation is small, which allows for fairly accurate determination of the ACO at one location for a particular peak period in a given quarter. However, because ACO varies by time of the year, day of the week, time of day, lane (or ramp), and location, comparisons involving small subsamples (such as one location for a particular time period in a given quarter) must take these variations into account.

An example will illustrate the variations that must be considered. For instance, if one were interested in determining changes in the evening peak ACO in the northbound general purpose lanes at 145th NE on I-5 from the last quarter of 1992 to the first quarter of 1993, one would have to take into account the number of observations in each of the following categories:

- day of the week
- time period during the evening peak
- the particular general purpose lane in which vehicles were observed.

If ACO turned out to be always higher on Fridays (because of families or other groups traveling out of town together for the weekend, for example), a larger sample of Friday observations in the second quarter could point to the misleading conclusion that ACO was increasing. Despite controls in the sampling methodology, it is not always possible to sample in a way that will prevent all potential misinterpretations of the raw data.

This section of the report deals with this issue. The data from Phase I and Phase II of the study were analyzed to determine differences by time of year, day of week, time



of day, lane (or ramp), and location. Awareness of these differences may be helpful in adjusting for sampling bias (see Appendix D for an explanation and examples).

### **ANALYSIS METHODOLOGY**

Statistical Package for the Social Sciences (SPSS) was used to convert ACO observation data for the entire year to a new format for analysis. ACO was calculated for each 15-minute period at each location for each lane (or ramp) during each quarter. Each ACO was then stored in a data file with its associated location, quarter, lane (or ramp), and time period identifiers. The SPSS data file contained 34,796 entries: 21,816 for observations in lanes and 12,980 for observations on ramps. Next, two separate files were created: one for freeway lanes and one for ramps. ACO figures based on fewer than 50 observations were deleted, and locations with fewer than 50 observations were also deleted. This reduction in the number of cases eliminated anomalous figures and reduced variability, but it maintained enough observations to conduct the analysis.

Following this reduction, 17,502 observations remained in the lane data file, and 10,755 observations remained in the ramp data file. Multiple regression was the general method for determining the influence of various factors on ACO. ACO was treated as the dependent variable, and various combinations of other information were used to determine the influence of factors such as location, time of day, day of the week, lane (or ramp), and time of year. The regression coefficients indicated the strength and direction of the influence of the factors of interest.

For instance, if the lane in which an observation was made was indicated by a dummy variable taking the value of 0 or 1 (depending on whether the observation was or was not in the lane), the regression coefficient for that dummy variable could be used to assess that lane's influence on its ACO. For example, if the coefficient for a dummy variable indicating lane 2 was .07, and the coefficient for lane 3 was .12, we could

conclude that the ACO was .05 higher in lane 3 than in lane 2 for the sample included in the regression. Furthermore, we could assess whether this difference was universal or was true only at some locations by comparing the regression coefficients for the total sample with the regression coefficients at each location. The differences in patterns of coefficients would indicate how locations varied. The regression coefficients for the overall analysis are shown in Table D1.

Differences in time of the year, day of the week, time of day, and lane (or ramp), were analyzed. Results are described in the following section.

### **TIME OF THE YEAR**

Multiple regression was performed on all data using location, lane (or ramp), day of the week, and time of day, as well as dummy variables indicating the quarter in which an observation was made. By separating out the influences of all relevant variables, the independent influence of time of year could be assessed.

By using the summer quarter data as a baseline, the relative influence of the other quarters can be seen (see Table D1). These data revealed that the summer ACOs (third quarter) were higher than those from the rest of the year. The coefficients for the remaining quarters did not differ significantly with one exception. The ramp coefficient for the second quarter was significantly higher than that of the Q4 and Q1. The general pattern is that ACO is lowest in the fall and winter, rises somewhat in spring, and reaches its highest level during the summer. One explanation is the increasing number of non-commute trips that people take during the spring and summer.

### **LANE ANALYSIS**

Lanes were classified by type: (1) HOV, (2) outer, (3) center, and (4) inner. The ACO in HOV lanes is obviously different from that in general purpose lanes;

consequently, the analysis concentrated on detecting differences among the general purpose lanes. The coefficient for the HOV lane is about 1.00 standard units higher than that in other lanes. This means that on average there was one more person in vehicles in the HOV lanes than in vehicles in the general purpose lanes.

The coefficients for inner and outer lanes did not differ significantly. However, the coefficient for the center lane was significantly lower than that for each of the two other lane types

### **TIME OF DAY**

ACO is clearly higher during the evening peak than during the morning peak. ACO data were analyzed separately for each peak period; this analysis concentrates on the variations within each peak period.

An overall multiple regression was performed using dummy variables for each 15-minute period in separate analyses for each peak period. (Figures D1 through D4 show the adjustment factors (based on the regression) for each 15-minute interval for each peak period.) Ramps and lanes were analyzed separately. In addition, a regression was performed on the adjustment factors to determine the general patterns.

Data for the morning peak (for both ramps and lanes) indicated a tendency for ACO to rise during the entire peak period, with a slight tendency for ACO to be higher in the very early part of the morning peak. The rise was statistically significant for both ramps and lanes. The most likely explanations for this rise are as follow:

- Commuters who want to drive by themselves tend to leave earliest to avoid traffic.
- Commuting carpoolers can leave later and still take advantage of HOV facilities.

- Toward the end of the morning peak period, non-work trips begin to influence ACO.

There is a general tendency for ACO to fall during the evening peak. However, the evening peak pattern is clearly U-shaped, and this "U" is statistically significant. During the entire evening peak, non-commuters (who tend to travel in higher occupancy vehicles) are prevalent (in comparison to the morning peak). However, during the peak of the peak, commuters (primarily in SOVs) reduce non-commuters' influence on ACO.

### **DAY OF THE WEEK**

ACO is lowest on Monday and increases throughout the week. The coefficient for Friday is significantly higher than that of all other days of the week. The rising trend during the week was found to be statistically significant. (Table D1 shows overall differences in ACO by day of the week.)

### **YEARLY CHANGES**

When all factors were accounted for, yearly changes could be detected. Between the 92-93 period and the 93-94 period, there was a significant, but small, increase (.014) in the ACO with respect to lane data. However, there was a significant decrease in ACO (.011) from the 93-94 year to the 94-95 year. Ramp data revealed a similar pattern (A .006 increase, followed by a .02 decrease).

### **CONCLUSIONS**

Many factors affect ACO. Therefore, it is important to design a sampling frame that reduces the influence of these factors. However, because it is impossible to perfectly sample all time periods, days of the week, lanes, and ramps at each location for the whole

year, it is important to consider these factors when changes in ACO are analyzed. After six years of data collection, we are confident in our understanding of these differences, but additional data will be important in confirming the analyses presented herein.

Caution should be exercised in applying these correction factors. However, in conducting such detailed analysis, it is better to apply them than to use the raw data without adjustments.

## CHAPTER FOUR: TRAVEL TIME DATA

Travel time data measure the time savings that HOV lanes provide over GP lanes. One commonly accepted standard for HOV lanes is that they must offer a time savings of at least 1 minute per mile. Another policy in Washington State guides decisions about occupancy requirements. According to the *Washington State Freeway HOV System Policy*, "HOV lane vehicles should maintain or exceed an average speed of 45 mph or greater at least 90% of the times they use that lane during the peak hour (measured for a six-month period)" (3). Travel time data collected in this project provide a variety of statistical information that will allow others to analyze time saving criteria when comparing HOV and GP lanes, and to apply lane performance criteria when evaluating HOV lanes.

Travel time data were collected using one of two methods outlined in the below. In the initial phases of this project the Baseline Travel Time method was used, but it proved too demanding on project resources to maintain. This gave birth to the Floating Car method [HOVTT (fcm)] which provided similar, but less reliable, travel time data. Both collection methods (and their findings) are discussed below, with brief explanations provided on their structure and methodology. Community Transit Automatic Vehicle Identification (AVI) travel times were also examined as a possible data source to supplement the HOVTT data, but hardware and technical support issues limited the reliability of this data source.

### **BASELINE TRAVEL TIMES**

Study sections for this collection method were specifically chosen to bound the HOV lanes' beginning and end points along given corridors. For the average traffic speed of GP lanes, vehicles traveling in the fast (leftmost general purpose) lane were observed, and their license plates numbers were tracked. To determine HOV lanes' average traffic

speed, the identification numbers of Metro buses traveling in the HOV lane were recorded. Average vehicle speeds were calculated from the time differences between matches of these identification numbers recorded at the beginning and end points of given study sections. (See *HOV Monitoring and Evaluation Tool* for a complete explanation.)

While observations on all of the corridors were scheduled to capture regular commute traffic flows, observations on the downtown I-5 and I-405 corridors captured reverse commute traffic flows as well.

Travel time data were organized along the following parameters:

- corridor of study
- beginning and end site (study section)
- morning or evening peak period
- traffic flow direction.

The data (see Appendix E) were arranged to indicate, in 15-minute intervals, the average vehicle speed observed in HOV and GP lanes during the morning and evening peak periods by quarter (in miles per hour). Because GP lane traffic speeds were drawn from fast lane observations, they sometimes exceeded the speed limit (because of the lane's use as a passing lane). Because their number varied over the length of each study section, the number of GP lanes was not included.

From July 1992 to July 1993, travel time data were collected from 21 sites (mainly overpasses), organized into 26 study sections. Of these, only two locations, S 260th on I-5 South and 35th Avenue S on I-90, were at street level. Data were available from Q3/92 through Q2/93. In Appendix E, corridor diagrams that indicate the study sections precede the data; these are followed by diagrams for each site. Comments made by observers as they collected travel time data refer to aspects of data collection, traffic, and weather conditions; they are contained in Appendix H.

## **Data Availability**

As indicated in the *HOV Monitoring and Evaluation Tool* final report, travel time data are difficult to obtain and expensive to produce for a number of reasons. Reliable data collection is hampered by a slow learning curve and the high amount of coordination required to schedule observations and ensure that collection periods match. In addition, factors associated with traffic patterns (such as vehicles changing lanes) can greatly reduce reliable data collection. Although a large number of travel time sessions were conducted in all of the corridors, it was difficult to obtain license plate matches during all peak-period times for all quarters. Consequently, quarterly average vehicle speeds are not consistently available for all given peak-period intervals.

In addition to the same weather-related problems that affect ACO data collection, travel time data are highly dependent on the number of successful license plate matches, which in turn is affected by several critical factors. First, gathering travel time data requires greater accuracy and faster reaction time than is required for gathering occupancy data. Therefore, this process is even more sensitive to conditions that reduce visibility. Second, gathering travel time data requires a "startup" period of at least 15 to 30 minutes, during which the vehicles observed at the beginning data point of a study section must travel to the specified end point before they can be observed and recorded. Third, the same license plates of passing vehicles must be recorded at each end of the study section, and for the same lane of traffic. Because vehicles rarely stay in the same lane, the likelihood that a vehicle has changed lanes or exited the freeway increases with the length of the study section. Fourth, observers cannot end and begin a session every half hour as they can when collecting ACO data; the breaks observers take add to the likelihood that a vehicle recorded by one observer will not be recorded by the other. Finally, average vehicle speeds can vary greatly from quarter to quarter.



### **Visibility**

Rather than viewing and recording the number of persons in a vehicle with a single digit, as is done in the case of occupancy data collection, observers must be able to discern and record strings of license plate characters. Each character is smaller than the size of a business card (7 cm high by 2.5 cm wide), and vehicles can be traveling anywhere from 24 to 105 kilometers per hour. Complicating this is the fact that the license plate numbers are usually read from overpasses, which place the observer from 6 to 11 meters above the traffic flow. Poor visibility because of weather and lighting only compounds the problem by restricting the length of the sessions. Additionally, some observers find that they perform the task best when traffic is approaching them, whereas others collect data best from vehicles moving away from them. Where these observers are limited by sites to record license plates from traffic that is moving the wrong direction, less than optimal observer performance occurs.

### **Observation Session Length**

Data are typically unavailable for the beginning period of the count because of the fact that the vehicles observed at the point of origin are not recorded at the end point until at least 15 minutes later, assuming that the observers even begin at the same time. This assumption is often not the case. Because two or more observers normally rely on a single vehicle for transportation to and from the sites, one observer has to drop off the other(s) before continuing on to the end site. Depending on the length of the corridor, this can add approximately 15 to 45 minutes to the start time of the session before matches can be expected (this is also true for session end times). If, as in the cases of I-5 and I-405, multiple travel time sessions are performed over long distances, the start-up time is greater.

### **Study Section Length**

Successful matches depend upon the plates of the same vehicles being recorded in the same lanes at both ends of a study section. The distance from the beginning to the end site of a study section, therefore, directly influences the number of successful matches because vehicles rarely remain in the same lane. As the distance between observation sites increases, the likelihood that the same vehicle will be recorded decreases because the driver is more likely to have changed lanes or to have exited the corridor altogether, depending on the availability of access/egress ramps. Furthermore, because GP vehicle speeds are derived from fast lane observations, the number of successful matches may be reduced because of the fast lane's use as a passing lane. (For a list of the study sections and their respective lengths, see Table E2).

### **BASELINE TRAVEL TIME SITES**

#### **I-5 North Corridor**

The I-5 North corridor is 8.2 kilometers long. It has three observation sites and consists of two study sections from which data were collected:

- 236th Street SW to NE 117th Street for morning inbound traffic
- NE 117th Street to NE 185th Street for evening outbound traffic

236th Street SW was selected because it was the northernmost site at which HOV lanes operated up to Q3/96; for this reason it was kept despite the fact that N 185th was later determined to be a better location (4). Both 236th Street SW and 117th Ave. NE had sidewalks on the north side only; consequently, observers had to count vehicles

coming toward them in the morning and going away from them in the evening (Figures E2 and E4).

For 236th Street SW to 117th St. NE (Table E3), fewer data were available for the morning commute because the study section was longer (see Table E2). Observations for both the winter (Q4/92) and spring quarters (Q1/93) were affected by inclement weather and a shorter daylight cycle, as indicated by the lack of data for the early morning (Table E3) and late evening (Table E4). For Q1/93, data were unavailable because only one count was performed for each section, and no reliable matches were made.

### **I-5 Downtown Corridor**

This is the second longest corridor at 18.8 kilometers long. It has four sites organized into six study sections:

- between Lakeview Boulevard E and S Holgate Street
- between Lakeview Boulevard E and Albro Place
- between Lakeview Boulevard E and S 144th Street
- between S Holgate Street and Albro Place
- between S Holgate Street and S 144th Street
- between Albro Place and S 144th Street

Lakeview Boulevard E was chosen to be the northernmost site of this corridor because it was also being used for vehicle occupancy collection (the HOV lane actually began further south, at Mercer). Although Lakeview Boulevard E was discontinued for occupancy counts, it continued to be used for travel times through Q2/93 (Tables E5 through E9). S Holgate Street was a difficult site to collect data from because it was uncomfortable for observers to sit at and had poor visibility (Figure E7). Its one sidewalk was on the north side. The overpass, situated on a steep hill, placed the observer in an awkward sitting position. Southbound traffic was 6 meters lower than northbound traffic,

and in the morning sun, license plates were difficult to see because of the shadow cast by the overpass (4). Visibility was good at Albro Place in both directions, but observers complained of the diesel fumes that collected there (Figure E8) (4). S 144th Street was the best location because it had wide sidewalks on both sides of the overpass (Figure E9).

Except for a few study sections where the distances between sites were short, travel time data for this corridor were sparse. Again, data were less available for the winter quarters, as well as for the longer study sections (such as Lakeview Boulevard E and Albro Place). Although HOV lane observations were successfully performed for each of the above study sections, no reliable matches were obtained from any of the data collected.

For the morning southbound commute from Lakeview Boulevard E to S Holgate Street, no data were successfully collected during Q1/93 (Table E5); for the evening southbound commute, no data were successfully collected during Q4/92 (Table E6). On Lakeview Boulevard E and Albro Place, one count each was successfully performed and matched during Q3/92 and Q4/92 of the morning southbound commute (Table E7); for the evening southbound commute, two successful counts were reliably matched for Q3/92, and one count for Q4/92 (Table E8). At the same study section for the morning northbound commute, data were successfully collected and reliable matches were obtained for only Q3/92 (Table E15 and E16). Of the one successful count performed at Lakeview Boulevard E and S 144th Street for the evening, southbound commute, one match was made (Table E9); no reliable matches were found from the single count performed for the morning northbound commute (Tables E20, E10, E11). For the morning northbound commute at S 144th Street to Lakeview Boulevard E, no reliable matches were obtained from the one successful count performed during Q3/92 (Table E20).

For the S Holgate Street to Albro Place study section, data were collected successfully for the morning southbound commute during Q3/92 and Q4/92 only (Table

E12). For S Holgate Street and S 144th Street, data were only collected and matched for evening, southbound traffic during Q3/92 and Q4/92 (Table E14); no data were successfully collected for the morning, northbound commutes (Table E21). For the Albro to Holgate study section, no data were successfully collected for the morning northbound commute during Q2/93 (Table E17); data were successfully collected for the evening northbound commute only during Q2/93 (Table E18).

### **I-5 South Corridor**

The I-5 South corridor was one of the project's more successful travel time data collection sites. This corridor is 8.9 kilometers long, had three sites, and consisted of two study sections from which data were collected:

- S 178th Street to S 216th Street for evening outbound traffic
- S 260th Street to S 216th Street for morning inbound traffic

Although a great deal of data were collected for the morning commute at S 260th Street to S 216th Street (Table E24), S 260th Street was a difficult and unsafe location at which to collect data. The site was located on the median dividing the northbound and southbound lanes, rather than on an overpass (Figure E13). To reach this site, observers parked on the underpass and scrambled up a steep dirt hill and around a chain link fence while carrying a folding chair and a laptop computer (4). In rain, the hill became very muddy and slippery (4).

Summer data for S 178th Street to S 216th Street were available later in the day than for any of the other travel time study sections. Data were collected until 7:15 PM to take advantage of the longer period of available daylight during that period (Table E23). Visibility for this corridor was adequate at all of the sites.

### **SR 520 Corridor**

The SR 520 corridor is 7.9 kilometers long, from Hunt's Point to 148th Avenue NE, and includes SR 908. This corridor was divided into three study sections, and data were collected for morning inbound and evening outbound traffic:

- Hunt's Point and SR 908
- Hunt's Point and 148th Avenue NE
- 148th Avenue NE and SR 908.

The location at Hunt's Point was a pedestrian overpass four blocks west of the vehicle overpass (Figure E15). It was particularly good for collecting data because observers could see well in both directions, and traffic was always almost stopped, which made it easy to record license plates (4). The only distinguishing feature of 148th Avenue NE (Figure E17) was that it carried a great deal of traffic, and observers reported that the occupants of passing vehicles often stared at them (4).

Although the study sections on this corridor were generally better than those in other areas, HOV lane data were very limited because the only HOV lane was an outer lane running from SR 908 to Hunt's Point for westbound traffic (sites 41 and 43 on Figure E14). Data on "reverse flow" traffic were briefly collected; evening sessions were conducted on the westbound traffic from Hunt's Point to SR 908 for Q3/92 and then were discontinued because of the insufficient number of matches for the HOV lane (Table E26). Data were not collected from the 148th Avenue NE to Hunt's Point section for morning westbound traffic until Q4/92 (Table E27). Data for evening eastbound traffic are missing for the winter quarters (Q4/92 and Q1/93), despite a relatively high number of sessions that were scheduled.

### **I-90 Corridor**

The I-90 corridor is 7.7 kilometers long and consists of two study sections from which data were collected:

- E Mercer Way to 35th Avenue S for morning westbound traffic
- 23rd Avenue S to E Mercer Way for evening eastbound traffic.

The neighborhood around 23rd Avenue S was not considered safe, especially in the dark for women, so male observers were preferred; this affected scheduling (4). Furthermore, observers had to stand to see the traffic because of the 1.2-meter high wall (Figure E19). Observers relied on either of two locations for observations at 35th Avenue S: they sat on the retaining wall on the overpass or on the bicycle path that is on the same level as the lanes, looking across traffic (Figure E20). Getting to this site was time-consuming because of the winding roads on Mercer Island; consequently, counts tended to begin later than usual--especially if a "drop-off" was involved (4). The retaining wall position, although less comfortable, offered better visibility. Visibility from E Mercer Way was adequate, although the location was heavily landscaped (observers were often sitting in bark mulch) (Figure E21).

Travel time data collection was successful for this corridor as well, except for two winter quarters for which data are unavailable. For 23rd Avenue S to E Mercer Way, data are unavailable because no matches were obtained from the four sessions for Q1/93 (Table E32); the same problem occurred for E Mercer Way to 35th Avenue S during Q4/92 (Table E33).

### **I-405 Corridor**

This corridor is the longest of the six corridors--27.5 kilometers, with ten study sections (also the most of any corridor). Because of the complexity of traffic patterns

(see Chapter 3, pp. 27-30), observations were conducted to capture both regular and reverse traffic flows at the following locations:

- Tukwila Parkway and Benson Road S
- Tukwila Parkway and 112th Ave. SE
- Tukwila Parkway and NE 12th Street
- Tukwila Parkway and SR 908
- Benson Road S and 112th Ave. SE
- Benson Road S and NE 12th Street
- Benson Road S and SR 908
- 112th Ave. SE and NE 12th Street
- 112th Ave. SE and SR 908
- NE 12th Street and SR 908.

This was the least successful corridor for collecting travel time data for a number of reasons. The root problem was that, unlike the corridor for the occupancy data, I-405 was not segmented into south, central, and north corridors because the study sections spanned the corridor's entire length. First, observation sessions were spread too thin. An average of only one to two counts were successfully performed for each applicable parameter (site, commute period, traffic direction). Second, most study sections were too long to obtain matches reliably. All but one were longer than 5 kilometers (Table E2) and had numerous access/egress ramps in between (Figure E23), thereby increasing the likelihood that observed vehicles would have changed lanes or exited the corridor altogether.

HOV data for the longer study sections are unavailable for similar reasons, and because the HOV lanes were neither continuous nor remained on the same side of the corridor. Inside HOV lanes began at Tukwila Parkway and ended at Benson Road S; yet from NE Park Drive to 112th Avenue SE, HOV lanes were on the outside. There were no



HOV lanes in the central and northern portions of the corridor during the time of this study. During Q2/93, data were only collected between the shorter study sections: Tukwila Parkway to Benson Road S (Tables E34, E35, E41 and E42); Benson Road S to 112th Ave. SE (Tables E43, E44, E50 and E51); 112th Ave. SE to NE 12th Street (Tables E52, E53, E60 and E61); and NE 12th Street to SR 908 (Tables E62, E63, E68 and E69).

Tukwila Parkway, 112th Avenue SE/Lake Washington, and NE 12th Street were average sites for collecting data (Figures E24, E26 and E27, respectively). Benson Road had good visibility and a wide sidewalk on the west--the sidewalk on the east side was very narrow (Figure E25). Observers recording travel time data from the pedestrian bridge at SR 908 during the winter had the same difficulties as they had experienced with occupancy data collection efforts (Figure E28).

### **COMMUNITY TRANSIT AVI PROJECT**

In 1992, Community Transit (CT) and WSDOT began a project to equip all of CT's Seattle express buses with automatic vehicle identification (AVI) systems. The system consists of three parts: a transmitter located under the bus, the use of induction loops embedded within the freeway as antennas, and a roadside receiver to record incoming data. The system piggybacks a signal on a freeway induction loop containing the bus' identification code and records the time, date, and location of the transmittal. At three-month intervals the data are downloaded and transferred to a personal computer for further processing.

In an effort to supplement the HOVTT travel time data, these records were analyzed to produce travel times and travel speeds along the North I-5 corridor between NE 120th St. and NE 185th St. for both the southbound and northbound direction. The methodology used to process the data utilized basically the same principles as the HOVTT analysis ("time stamps" and distance calculations) but to a higher degree of

accuracy and precision because of the collection method. In an effort to make the AVI data more comparable to the HOVTT data, only data within the given peak commute periods (6:00-9:00 AM and 3:00-6:00 PM) were considered for determining travel speeds. AVI data were not available between Q2/96 and Q2/97 because of sound wall construction along the I-5 North corridor. Use of this data as a supplemental source of travel time data was discontinued Q1/98 due to various hardware and technical support issues.

### **HOVTT (FCM) PROJECT**

The collection of travel time data using the license plate matching method required a substantial investment in personal, equipment, and time. Several alternatives were examined to determine the most favorable collection method, given the constraints imposed by the project's financial limitations. The HOVTT (fcm) program was the result.

Data collection is facilitated by sending observers out into the peak hour commute to record real-time spot checks of the HOV system. Observers are instructed to observe the flow of traffic within the HOV lanes and to maintain a speed equivalent to other HOV commuters. These sessions require two observers (three on SR 520) to satisfy the HOV lanes' vehicle passenger requirements: one person to drive and the other to run the data collection program. The HOVTT (fcm) program records travel times through a series of "time-stamps" entered when the observer reaches a designated point along the freeway. During a session observers loop along a given corridor collecting travel times for each period they traverse a section. Currently, eight corridors are under observation within the Puget Sound region and are defined further in Appendix F.

### **Determination of Travel Speed**

On a weekly basis all of the HOVTT files created go through an analysis process to convert these record "time-stamps" into useable travel speeds. This is accomplished by linking each "time-stamp" with the milepost of its data entry point. The milepost of each point was determined from the State Highway Log, and final travel speeds deduced by examining consecutive data entries within any given file to find the distance between them and the time elapsed. The resulting travel speed is the quotient of the distance by the time differential.

Results are recorded in weekly reports that catalog the file's name, the observer's name, the section speeds recorded, and any data errors and/or adjustments made to the data. Occasionally errors are made when the data are entered, and adjustments are necessary. These errors are quite evident, and all time corrections are documented on both the weekly report and within the file itself.

### **Limitation of Analysis Procedure**

Although this method is very efficient in a financial sense, the data's sensitivity to true travel times are dependent on a variety of factors. Things such as the observer's driving style, the exact point of data entry, weather conditions, congestion levels, adjustment of data errors, and day of week all have an uncertain effect on travel times. Normally, variances within the data are accounted for by obtaining a large sample size. Utilizing this method of data collection results in relatively small sample sizes. Therefore, anyone drawing any conclusions from the data presented herein should be warned that these results can not be considered statistically significant.

### **Interpretation of Data and Graphs**

Appendix F represents the performance summaries of all corridors under observation between October 1, 1995, and March 31, 1998. There are several tables for

each corridor, one for each direction of travel (e.g., southbound, northbound, westbound, eastbound) and peak commute period (e.g., AM or PM). Tables are divided by corridor sections and include the following values: the minimum and maximum speeds, the median speed, the average speed, the standard deviation of the data population, the 90<sup>th</sup> percentile travel speed (speed that 90 percent of the data points exceed), the percentage of data points exceeding the 45 mph criterion, and the number of data points. The tables in Appendix G are divided by the same corridor sections and provide average speed data that compare the performance of HOV lanes to adjoining general purpose lanes. Corridor section numbers are organized by increasing milepost (generally south to north or west to east).

#### **HOVTT (FCM) DATA RESULTS**

HOVTT data continued to show that the HOV system within the Puget Sound provide a sizable benefit in travel time savings. Table 4.1 summarizes the travel time savings observed along the various corridors during Q1/98.

Each of the corridors is examined to determine the benefits experienced by HOV commuters and whether performance levels satisfy the criterion established by Washington State Freeway HOV System Policy. When possible trends are evaluated, only data from the same quarters (e.g. Q1/96 vs. Q1/97) will be examined to minimize seasonal fluctuations of travel times. Each of the corridors is also examined to determine where a section of the system has failed to meet the criterion and an attempt is made to provide a possible reason for the low speeds.

**Table 4.1: Travel Time Savings in Seconds per Mile (spm) between HOV Lanes and General Purpose Lanes Determined from Weighted Average Speed**

Observation Corridor	Southbound (& WB)		Northbound (& EB)	
	Morning	Evening	Morning	Evening
I-5 North	12.5	15.5	5.8	2.6
I-5 Downtown	2.9	9.7	3.6	35.9
I-5 South	0.1	12.3	8.9	2.9
SR 520	11.5	151.6	N/A	N/A
I-90	4.6	1.5	2.2	7.2
I-405 South	6.2	26.2	102.8	14.6
I-405 North	16.7	2.4	1.5	21.4
SR 167	4.1	5.5	18.5	14.9

**I-5 North**

In September 1996 a new segment of HOV lane opened in the northbound direction between NE 185th Street and 164th Street SW in Lynnwood. Over the last three quarters of observation, northbound performance levels continued to outshine those observed before the opening of the HOV lane extension. Most sections surpass the HOV policy criterion with an impressive stability in travel speeds realized by evening HOV commuters. Opening the section of HOV lane between NE 185th St. and Lynnwood was instrumental in stabilizing travel speeds along this section of freeway.

However, one particular concern was the decline of performance levels during the southbound morning peak period for any given quarter in relation to the commuters' proximity to the express lane entrance. This reduction in speed may be due to friction with congested adjacent general purpose (GP) lanes. WSDOT is constructing a new lane configuration at Northgate to help alleviate this tension and elevate travel speeds. The current southbound morning performance levels showed an increase in comparison with the previous year's levels, with average travel speeds favoring HOV commuters by 6 mph

(10 kph) to 15 mph (24 kph). HOV traffic moving in the opposite direction of the peak commute (e.g., northbound AM and southbound PM) had no problem meeting the selected standards. A new segment of HOV lane from 164th Street SW to the SR 526 (Mukilteo Speedway) opened July of 1998 extending this corridor by 5.7 miles.

### **I-5 Downtown**

The HOV lane southbound through the downtown Seattle corridor was recently extended from its previous terminus at the Boeing Access Road to the I-405 interchange providing a continuous HOV lane from Federal Way into Downtown Seattle. Thanks to the added HOV capacity, performance levels during the southbound evening commute continue to exceed the state's HOV policy regarding travel speed and reliability.

Commuters traveling along the HOV lanes continued to enjoy travel time savings of 35.6 seconds per mile (spm) during the northbound evening commute and 9.7 spm during the southbound evening commute. The largest concern along this corridor continued to be decreased performance levels near the northern terminus of the northbound carpool lane. One final trend was the apparent decline in performance levels for sections between Albro Place and Holgate Street. This trend is due to construction by WSDOT to seismically retrofitting the bridge columns along this section of freeway.

Collection along this corridor was performed on a low priority basis. This means that sessions were usually conducted on the way to and returning from other corridors, rather than targeting the corridor itself. Therefore, data for the downtown HOV lanes were usually collected at the beginning and/or end of the peak commute time. The result may be that observed trends were biased or skewed.

### **I-5 South**

Performance along the HOV lanes between Southcenter and Federal Way was consistent with previous quarters' observation. The I-5 South corridor did not satisfy the

HOV policy requirements during the southbound evening peak commute. Performance levels dropped significantly during Q1/98 when compared with levels for the same period of the previous year, but southbound HOV commuters still realized travel time savings of 12 spm, even with the current heavy levels of congestion. One should note that construction along the Southcenter Hill was still ongoing during Q1/98 observations. The new HOV lanes passes through the I-405 interchange so that buses can maintain their speeds up the incline at the Southcenter Hill.

### **SR 520**

This HOV lane is not utilized as heavily as other HOV lanes because of its 3+ person requirement. The HOV lane is squeezed in on the right shoulder, primarily to allow freeway flyer buses a congestion bypass route to the Evergreen Point floating bridge. The result is a lane that possesses little or no shoulder, blind corners, and problems with merging ramp traffic. All of these reduce travel speeds for the HOV commuters. Understandably, no sections along this corridor met the travel speed criterion. A brief study of the situation would reveal that the problem with the lane is not limited capacity but drawbacks in design and function. Because of equipment problems and time limitations, a complete set of data was not collected for this corridor.

### **I-90**

HOV lanes along the I-90 corridor were relatively free of congestion in all directions and at all peak commute times. The data have remained uniform over the history of the project, with travel speeds concentrated near the posted limits. This corridor was also designated as a low priority, but these trends were supported by I-90's history of lower congestion levels. Apparently, the system here performed above expectations and needed no additional design measures. Observers did comment that

traffic along the general purpose lanes between East Mercer Way and downtown Seattle appeared to be more congested than in previous quarters.

### **I-405 South**

WSDOT completed its restriping project in February 1997, effectively eliminating the HOV lane cross-over at the Renton S-curves, and successfully relocated the HOV lanes to the inside of the freeway as far north as the I-90 interchange. The result is an HOV lane that provides consistent, fast travel along its entire length. Performance levels during all peak periods and directions have improved dramatically over those recorded before the restriping project.

The freeway here continues to support peak commutes in both directions of travel beyond the capacity of the road's two general purpose lanes. Southbound performance levels continue to exceed those recorded during the first quarter of 1996 by approximately 10 percent to 20 percent, but performance levels lagged behind the HOV policy criterion in a few key areas, namely the SR 167 interchange and the I-5 interchange. The evening commutes benefited greatly from the switch with sizable improvements in performance levels along all affected sections.

The biggest highlight of this corridor was the travel time savings achieved by HOV commuters. During Q1/98, the HOV lanes along the I-405 South corridor obtained travel time savings ranging from 6.2 spm to an amazing 102.8 spm (1 min. and 42.8 sec per mile). In general, the switch of the HOV lanes to the inside lane increased the stability of travel time for HOV users.

At this time, travel time data collection is not scheduled to begin again until October 1998, with the next quarterly report due January 1999. Future plans call for relocating all remaining I-405 outside HOV lanes to the inside lane. This reconfiguration should help reduce instability in travel speeds along the Eastside HOV system.



### **I-405 North**

HOV performance along this corridor varied greatly, depending on the time of commute. The morning peak period fared better than the corresponding evening commute. Only two sections failed to reach the 45 mph standard during the morning commute during Q1/97: southbound between NE 124th Street and SR 908 in Kirkland (58.1 percent), and northbound along the southern terminus (83.3 percent). Results from the evening commute made evident several areas of concern along both directions of travel.

Northbound HOV lane performance was variable, with several sections posting 5 percent to 20 percent decreases in performance levels making evident two areas that need improvement. The first was the weave problems produced by the SR 520 interchange. The second was the back-ups between NE 124th Street and the northern terminus of the HOV lanes. In November of 1996, the HOV lanes at the NE 160th Street Overpass were opened, but they did little to alleviate congestion levels at the terminus of the northbound HOV lanes because of new construction on the SR 522 interchange.

The most alarming issue along the southbound HOV lanes was the apparent decline in performance levels. Further analysis of the HOVTT data showed that the decline in performance levels originated from two possible areas of concern. The first was the Totem Lake on-ramps (NE 124th St.), where high levels of morning commute traffic merge through the outside HOV lanes. The second centered on sections south of the SR 520 interchange that pass through Bellevue's CBD. As stated before, the HOV lanes will eventually be switched to the inside, which may help stabilize travel speeds through these problem areas.

### **SR 167**

These HOV lanes, opened in November of 1994, performed well in both the morning and evening peak commutes. HOV performance along the commute direction

(e.g., northbound AM and southbound PM) was encouraging, with average travel speeds in the mid-to-upper fifties and travel time savings ranging from 4.1 spm to 18.5 spm.

Currently, this corridor is undergoing heavy construction between the HOV lanes' southern terminus and SR 18 as work continues to add another 5.5 miles of HOV lane in each direction. This project is scheduled for completion in autumn 1998. With further expansion of this route, the need for a complete freeway-speed interchange between I-405 and SR 167 will continue to grow. The present collector-distributor design is grossly inadequate for the level of demand.

### **CONCLUSIONS AND RECOMMENDATIONS**

Although the effort to collect reliable travel time data using the matching license plate method was educational, the usefulness of the baseline travel time data presented in this report is limited. Although the data can generally be used to compare HOV lane performance to GP lane performance and to identify areas of congestion, a number of factors render data interpretation difficult. Baseline travel time speeds can only be compared by time of commute for the quarter in which they occurred. Because the data are presented as average speeds, only individual study sections may be used; the data should not be aggregated to examine the differences between HOV and GP lanes corridor-wide.

It was much more difficult and complex to collect baseline travel time data than it was to collect vehicle occupancy or floating car travel time data. Observers not only had to be more accurate and have better visibility, they also had to coordinate their efforts more carefully. Even with good data, matches were difficult to obtain because of normal traffic behavior (e.g., lane changes), especially over long distances. Intervening access/egress ramps in study sections only compounded this problem. Despite the obstacles that made it difficult to collect the baseline travel time data, the experience

gained in this study indicates that travel time data may be collected successfully under some conditions. The greatest quantity of baseline travel time data was gathered at study sections characterized by good visibility, short length, and high numbers of successful observations. If manual baseline travel time observations are re-established, the following recommended actions should make the data collection effort more successful:

1. Use short travel time study sections. To decrease the likelihood of observed vehicles changing lanes or exiting the corridor, distances between sites should be short (for example, under 3 kilometers) and chosen to limit the number of intervening access/egress ramps.
2. Conduct more travel time data collection sessions per study section. Although a number of factors reduce the likelihood of obtaining reliable license plate matches, one way to compensate is to increase the number of data collection sessions, thereby increasing the volume of license plates collected.
3. As a special study, conduct travel time observations using the express lanes. Not only do the express lanes have GP and HOV designations, they also constitute a "captive audience" in that vehicles may not exit for longer distances. As a result, it may be easier to obtain the matches necessary for reliable travel time data.

Effective collection of baseline travel time data requires a great deal of coordination between observers to ensure that they begin and end at the same time, as well as corridor sections that facilitate license plate matches. Even when travel time data are effectively collected, they can vary so much that routinely gathering data to establish

an "overall" travel time statistic for a length of corridor may not be very useful. Because of this fact, future travel time data will be collected by means of the floating car method outlined above. The following recommendation is proposed to better facilitate the collection of HOVTT (fcm) travel times.

4. Index funding for data collection efforts with the opening of new HOV lane miles: Maintaining current HOVTT (fcm) and ACO data collection for all sites originally observed during the baseline data collection period is required to evaluate the effect HOV lanes have on regional traffic patterns. Additional support will be required from associated agencies as new HOV lane miles are added to the system to maintain the level of observations required to produce significant samples of data for HOV lane evaluations.

It is important to maintain levels of data collection so that time based trends are not missed because of insufficient data. To maximize the project's resources, travel time data will be collected during the first and fourth quarters of each year, when limited light conditions make ACO data collection less reliable. Summary data tables are located in Appendix F and G.

## CHAPTER FIVE: PUBLIC OPINION SURVEY

The research methodology used to collect the data described in this chapter is detailed in the companion report, *HOV Monitoring and Evaluation Tool (1)*. Users of these data should be aware that the sample used in this survey was not intended to represent the actual driving population. Rather, this portion of the project attempted to generate comparable samples of single occupant drivers and carpoolers to measure differences in their attitudes about HOV lane use and effectiveness. However, the sample generated for this survey comprised 64 percent SOVs and 36 percent HOVs. This may be because travelers identified as driving HOVs may have been carpooling under special circumstances when observers recorded their commute mode in the field. In addition, the survey was mailed to each vehicle's registered owner and thus may not have been received by the driver observed in the field. Only 44 percent of the drivers originally identified in the field as HOVs reported that they actually rideshare on a regular basis. On the other hand, 20 percent of drivers originally identified as SOVs reported that they rideshare on a regular basis. This underscores the uncertainty of correctly linking commute mode on any given day to overall mode choice. It is also important to note that this survey was intended to measure only attitudes about HOV lane effectiveness, not the underlying reasons behind individuals' choices to drive alone or to rideshare.

Three supplemental pieces of information were recorded with each returned survey. First, the postage date was entered to measure changes in opinions over time. Second, data entry staff recorded the commute mode in which survey respondents were traveling when they were observed by the traffic counters. Third, each survey was assigned a document number so that the phone numbers and addresses of respondents who indicated their willingness to answer follow-up questions could be retrieved from storage.

Between July 1993 and June 1998 surveys were mailed to 38,219 owners of vehicles identified by traffic observers in the field. Drivers of vehicles identified as HOVs received 17,590 surveys; 4,118 returned them, for a response rate of 23.4 percent. Drivers of vehicles identified as SOVs received 20,629 of the surveys; 4,473 returned them, for a response rate of 21.7 percent. The response rate for the entire survey population was 22.5 percent. These values represent a .9 percent decrease in the response rate from the survey period that ended May 1996. The current size of the survey database compiled since November 1992 is 8,591 cases.

In addition to providing results from all questions on the questionnaire, this section contains several examples of how to use the survey data in conjunction with other data gathered for this project. The purpose of this project is to develop a wide ranging source of data that will allow analysts to evaluate the performance of the HOV lane system. Therefore, illustrative examples that demonstrate how to combine the disparate sources of data are provided, rather than a comprehensive analysis. Subsequent quarterly reports will contain additional examples of noteworthy trends and changes from the baseline data.

The bulk of the survey data is presented in aggregate form, treating SOV drivers the same as carpoolers. However, opinion data are presented by splitting these two groups. Many of the figures are based on data collected from January 1997 until June 1998 to better illustrate the changes in demographics and opinion since the previous survey period. Any changes in opinions or trends were examined, and the results are presented in a graphical format. A copy of the public opinion survey is contained in Appendix I, and comments by survey respondents are presented in Appendix J.

## **TRAVELER DEMOGRAPHICS**

To better acquaint users of these data with the survey population, demographic data are presented before sections relating to driving patterns and opinions on HOV lane effectiveness. This presentation of the results does not correspond with the order of the questions as they appeared on the survey, but it will facilitate interpretation of following sections.

It was impossible to ensure that the actual driver of the auto observed in the field would respond to the survey if more than one person in the house commuted to work. Therefore, we asked that the survey be filled out by the person in the house who commuted most often.

Figure 5.1 depicts the gender of survey respondents. In Figure 5.2, the distribution of the respondents' age is shown. Figure 5.3 examines the level of education respondents have reported.

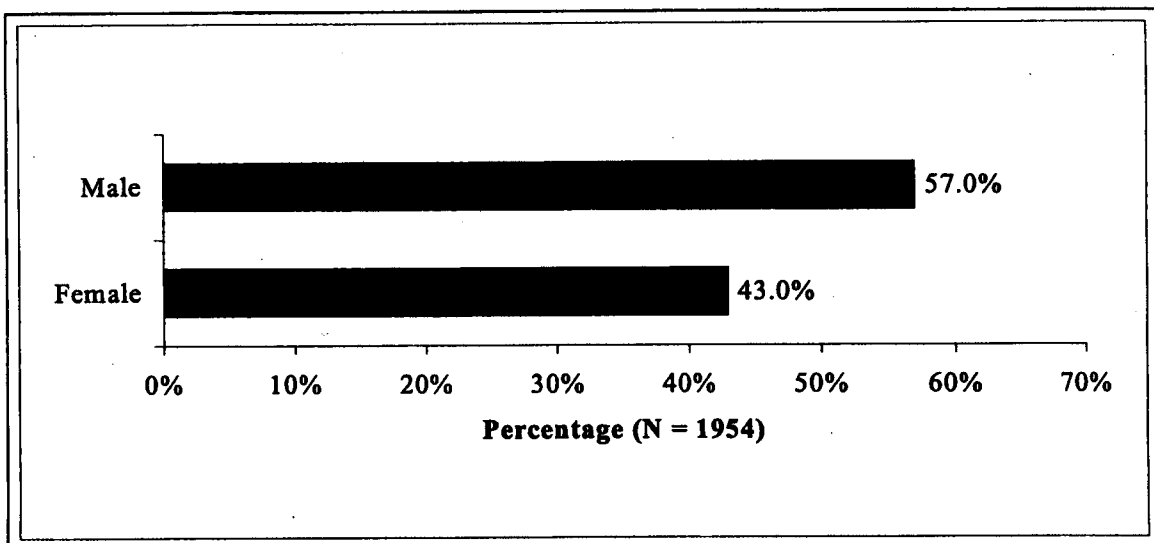

**Figure 5.1 Gender of Respondents:** The percentage of female respondents decreased slightly in comparison to previous results.

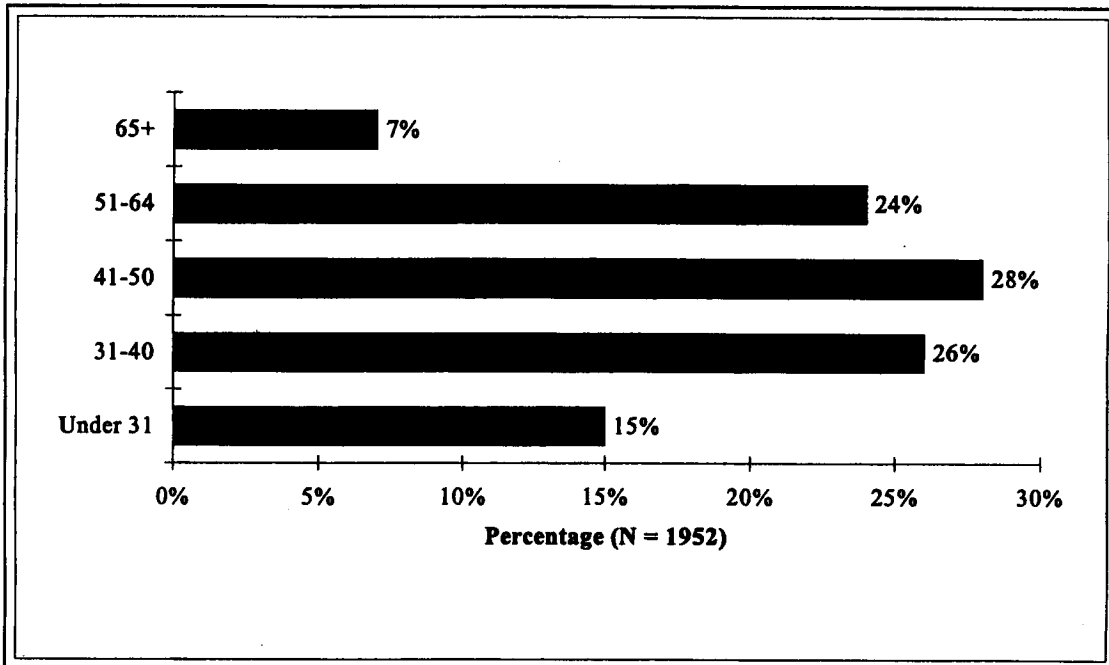

**Figure 5.2 Age of Respondents:** The overall age distribution of peak hour commuters is shifting when compared with the results of the 1996 report reflecting an aging population.

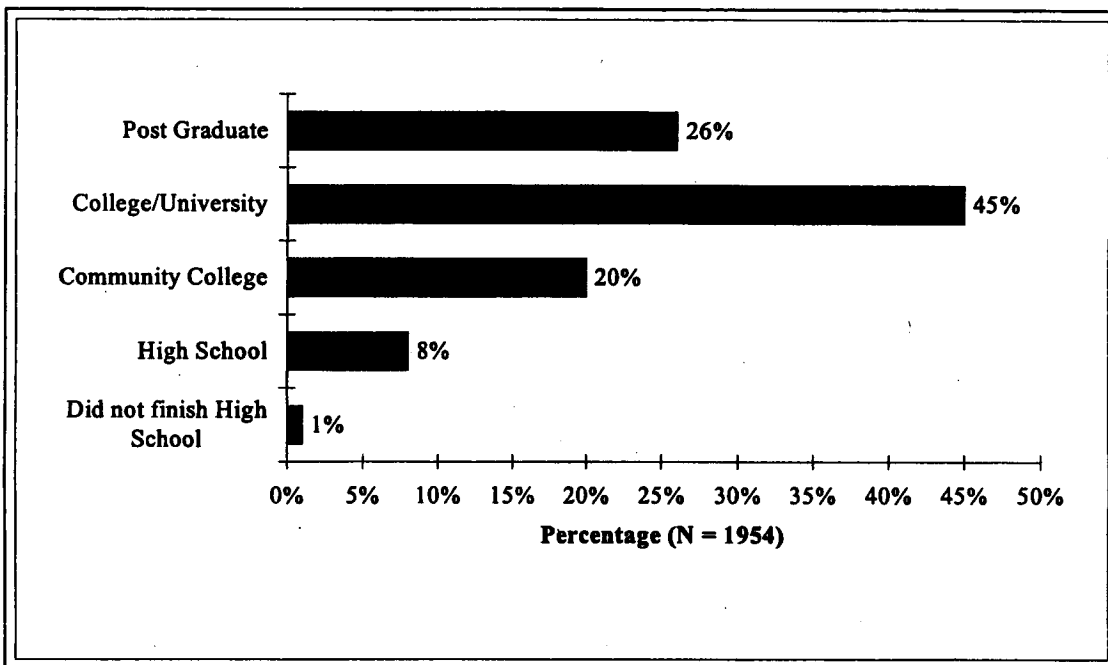

**Figure 5.3 Education Level of Respondents:** Seventy one percent of survey respondents possess a college degree or post-graduate education. People with a relatively high level of education may be more inclined to respond to surveys than those with less education.



The public opinion survey asked respondents to provide information on their domestic conditions, including the number of people living in the household, the number of children age 15 or less to determine the number of eligible drivers, the number of people working outside the home, and the number of vehicles owned by residents. Table 5.1 shows the most common clusters of domestic conditions for survey respondents.

**Table 5.1: Domestic Conditions of Respondents**

<b>Domestic Conditions</b>	<b>Number</b>	<b>Percentage</b>
2 people living in house No people under 15 years of age 2 people working outside house 2 vehicles	<b>362</b>	<b>18.35</b>
1 person living in house No people under 15 years of age 1 person working outside house 1 vehicle	<b>123</b>	<b>6.23</b>
3 people living in house 1 person under 15 years of age 2 people working outside house 2 vehicles	<b>114</b>	<b>5.78</b>
3-4 people living in house 2 or less people under 15 years of age 2 person working outside house 3 vehicle	<b>101</b>	<b>5.12</b>
2 people living in house No people under 15 years of age 2 people working outside house 3 vehicles	<b>87</b>	<b>4.41</b>
2 people living in house No people under 15 years of age 1 person working outside house 2 vehicles	<b>85</b>	<b>4.31</b>
4 people living in house 2 people under 15 years of age 2 people working outside house 2 vehicles	<b>80</b>	<b>4.05</b>
3-4 people living in house 1-2 people under 15 years of age 1 person working outside house 2 vehicles	<b>79</b>	<b>4.00</b>
Other/No Response	<b>942</b>	<b>47.75</b>
<b>Total</b>	<b>1973</b>	<b>100.00</b>

Figures 5.4 and 5.5 show the normal commute and trip routes for survey respondents. Originally, the commute route was determined by the highway corridor in which motorists were observed. This designation could then be used to measure sub-regional differences in opinion about HOV lanes. However, many respondents were observed in locations outside their normal commute routes or had commute routes that included more than one traffic observation corridor. To best analyze sub-regional differences in opinion, the commute route information was broken down into categories containing complete information on the commute route and other travel during peak hours. The major freeways located within the Puget Sound region were divided into ten corridors.

- |    |             |     |        |
|----|-------------|-----|--------|
| 1) | I-5 North   | 6)  | I-405  |
| 2) | I-5 Central | 7)  | SR 16  |
| 3) | I-5 South   | 8)  | SR 167 |
| 4) | I-90        | 9)  | SR 410 |
| 5) | SR 520      | 10) | SR 512 |

The percentage given represents the use of a given corridor by the survey population and not the percent of total use for freeway corridors within the Puget Sound region.

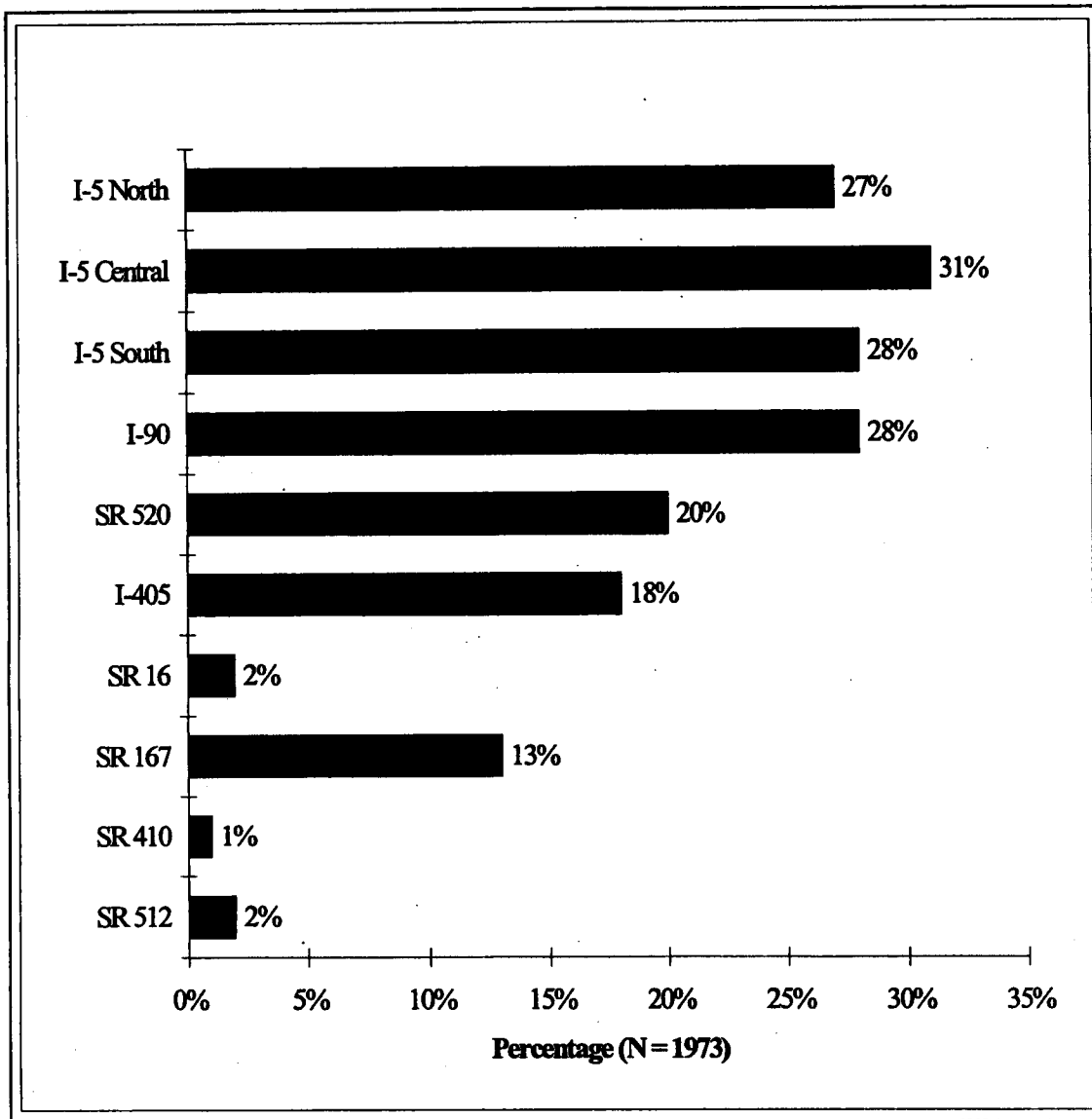

**Figure 5.4 Normal Commute Route:** This chart represents the true percentage of usage of the desired commute corridor.

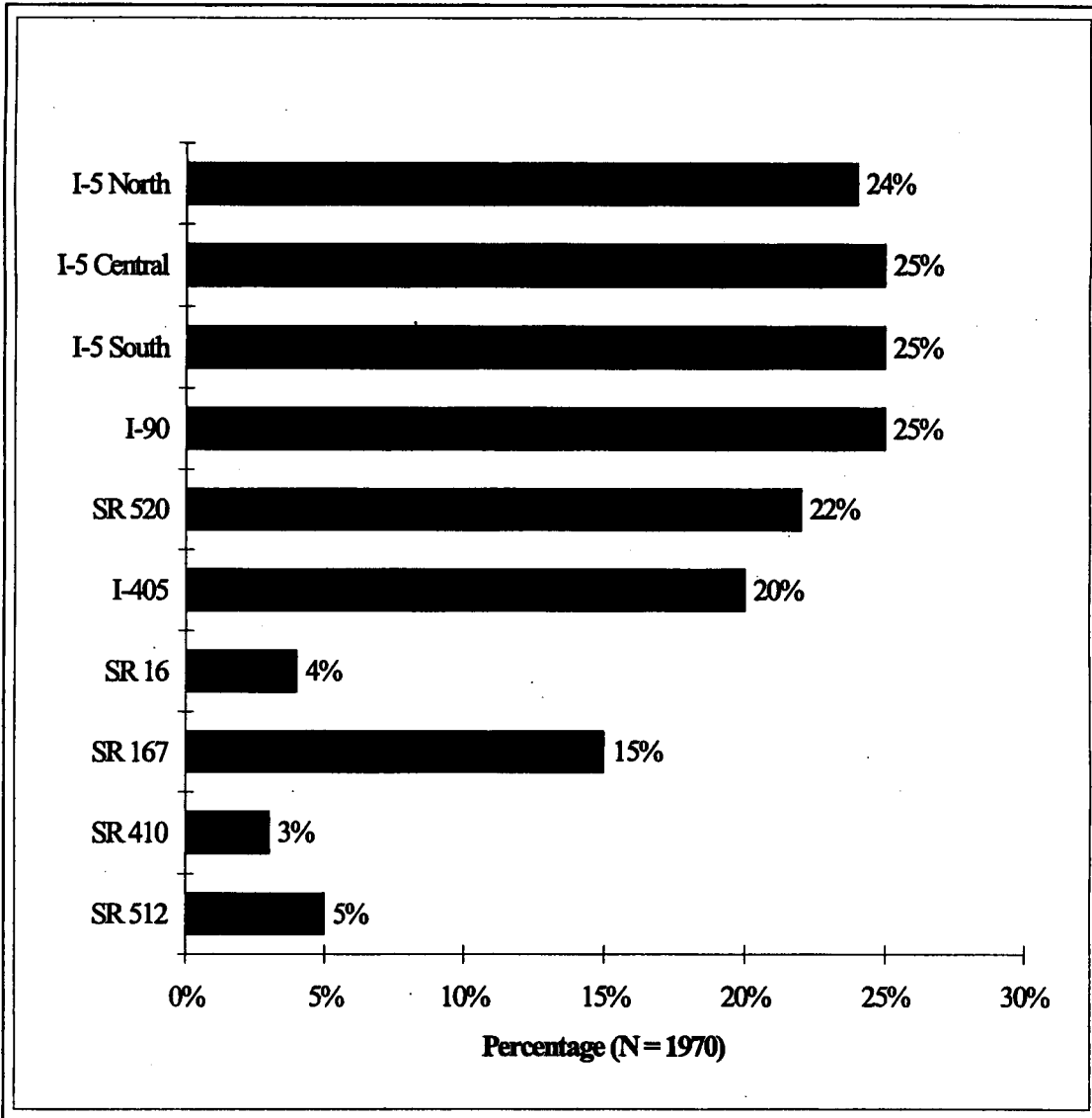
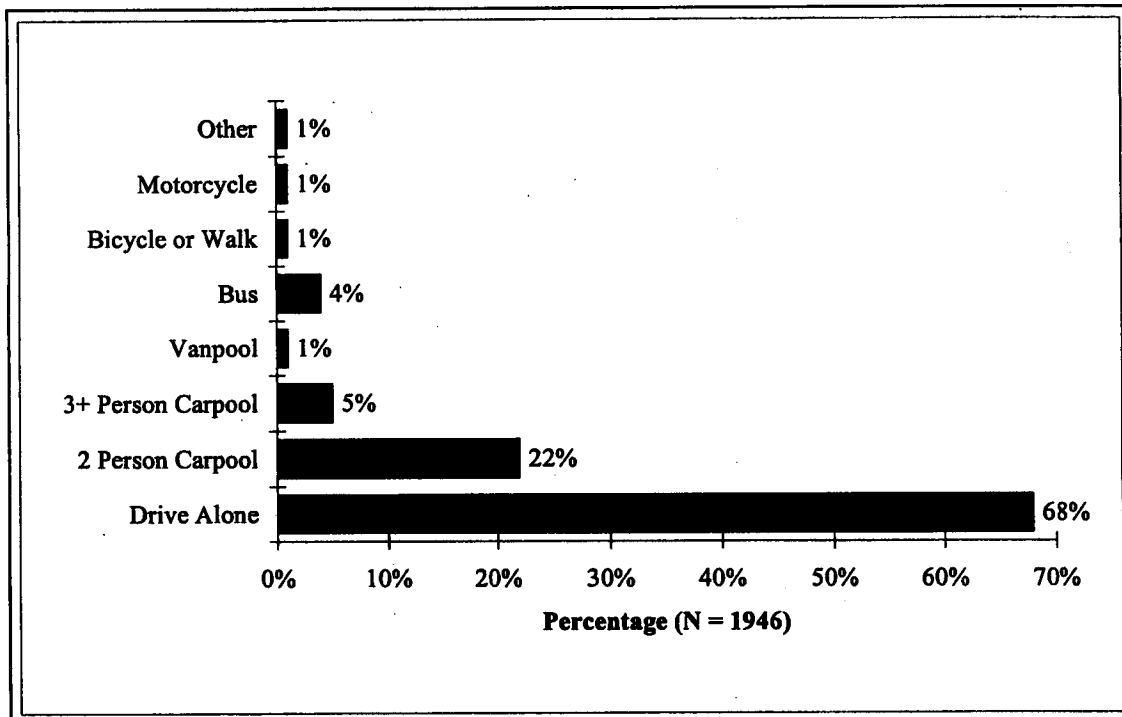

**Figure 5.5 Normal Trip Route:** Again, this chart represents the true percentage of usage of the desired commute corridor.

## TRAVELER COMMUTE TRIP

One of the controls for classifying survey responses is commute mode. Respondents' commute modes were determined visually by an observer during the peak hour counting sessions. Vehicles were selected from both the HOV lanes and general purpose lanes at random. A vehicle's license plate was then recorded, sent to the Department of Motor Vehicles, and returned with the registered owner's name and address. Unfortunately, the observed driver is not necessarily the registered owner, so asking the respondent to specify the commute mode of choice helped to avoid any confusion on this point.

Figure 5.6 shows the actual commute modes of survey respondents. For the purposes of later data analysis, the 2 Person Carpool, 3+ Person Carpool, Bus, Vanpool, and Motorcycle responses are combined into an HOV category. Motorcycles are added to the HOV category because these vehicles are allowed to use the HOV lanes.

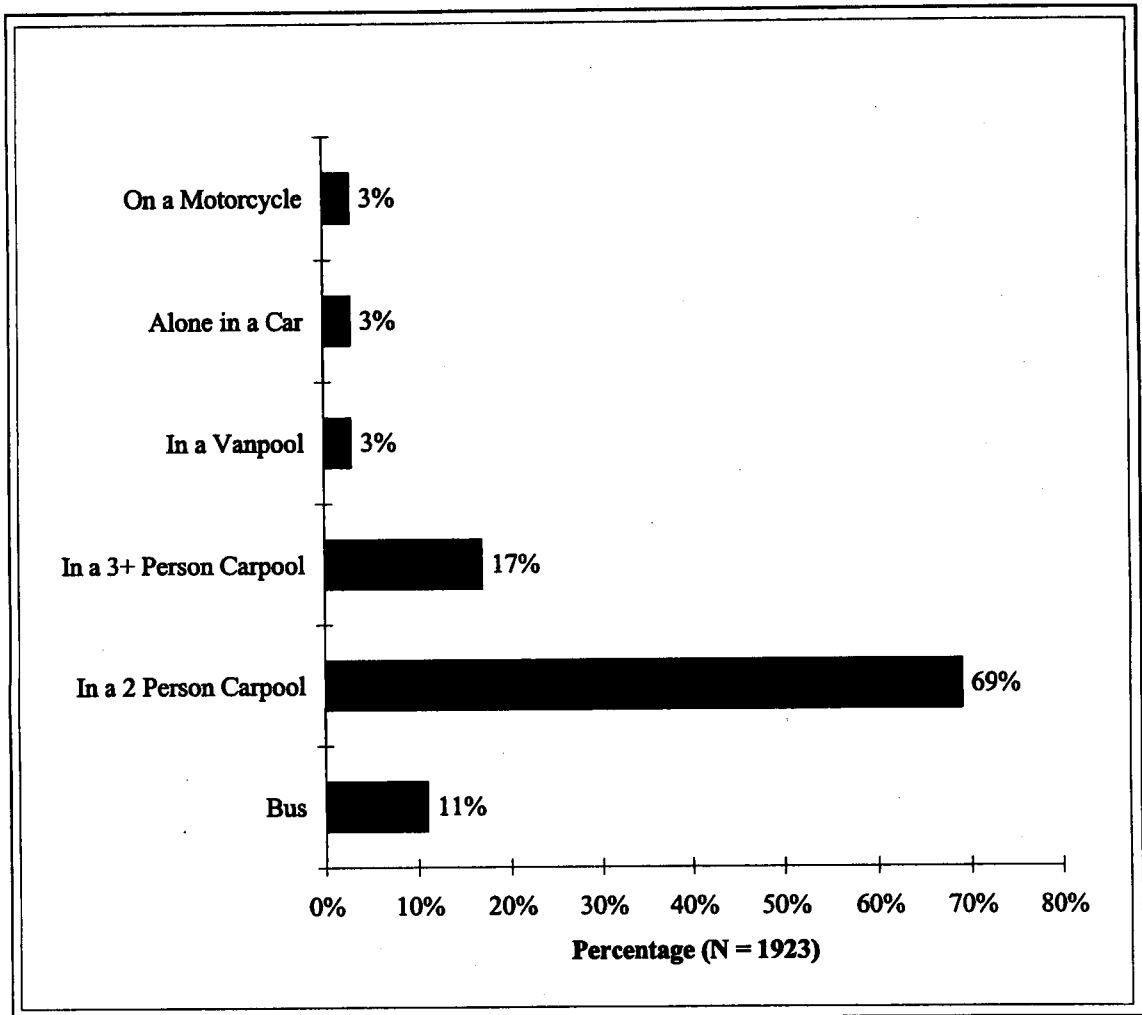

**Figure 5.6: Commute Mode: SOVs far outweigh those who rideshare, despite attempts to generate comparable samples of HOV and SOV drivers.**

Figures 5.7 and 5.8 provide information on past use of HOV lanes. Respondents were asked to indicate which HOV lanes they have used and their usual driving mode while utilizing them. The total of the percentages exceeds 100 percent because respondents were asked to indicate all options that applied to their past use of HOV lanes; therefore, an individual might have used HOV lanes in more than one mode and on more than one of the designated highway corridors.

Trends in HOV commute mode have remained fairly consistent, dominated by 2 and 3+ carpools. The percentage of respondents along all the observation corridors who have used HOV lanes also remained fairly consistent. These mode choices are influenced by a variety of factors, one being the pressure of congestion levels. It is possible that commuters are responding to congestion pressures and subsequently have altered their commute mode for a more favorable option, namely HOV lanes.

It should be understood that these opinions are compiled from the responses of returned surveys. Because of the random nature of the mailing and those returning the surveys, conclusions drawn from this data should not be considered completely representative of the driving population; rather they should be considered and further investigated in a more analytical fashion.



**Figure 5.7 Past Use of HOV Lanes:** The high response percentage in 2-Person and 3+ Person carpools could suggest that HOV lanes are popular during the work week when employees commute together. There was a sharp increase in the percentage of respondents selecting the 2 person carpool option (+31 %) when compared with previously recorded levels. Because of the wording of this question (ever use vs. usually use), the class percentages are higher than those of Figure 5.6.

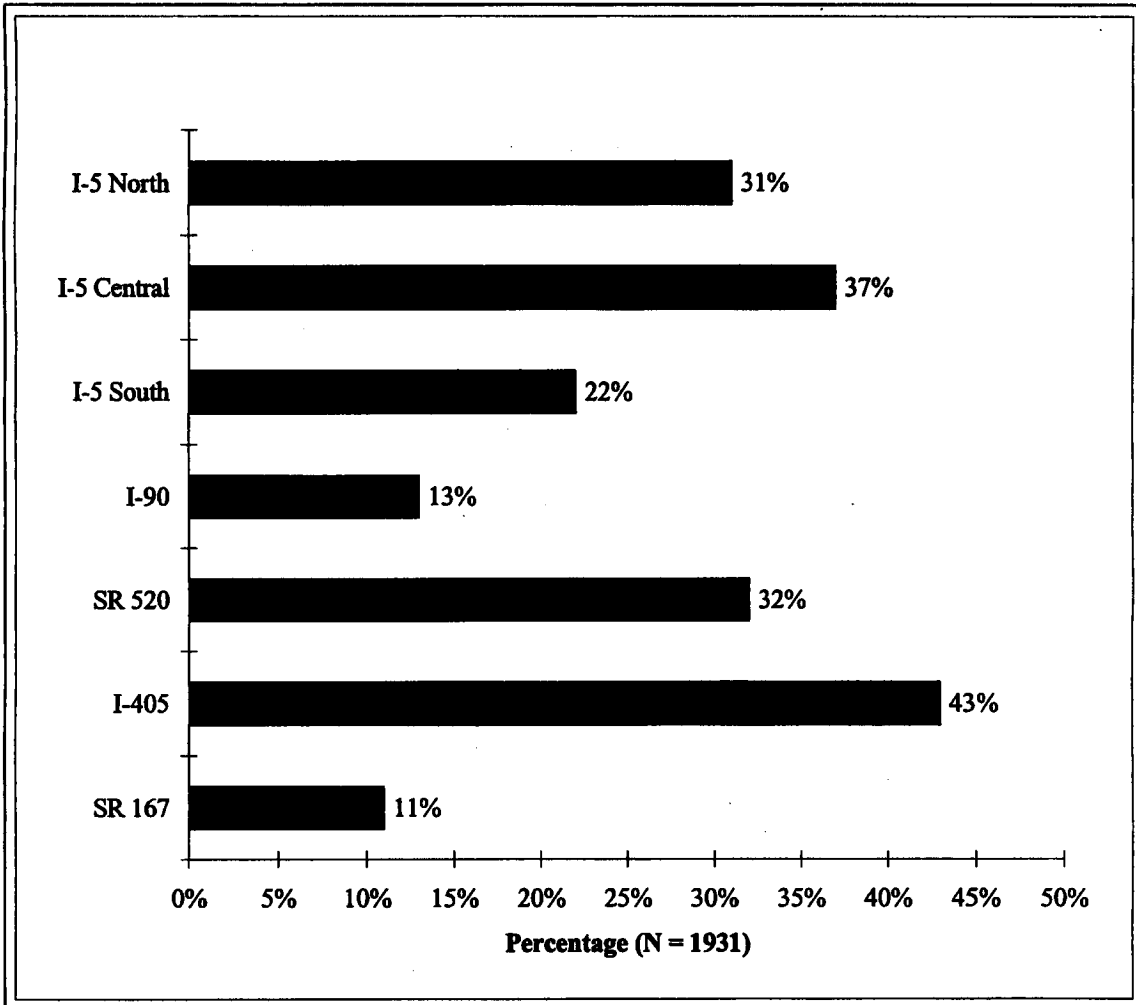

**Figure 5.8 Past Use of HOV Lane Corridors:** Again, the frequency of drivers who have utilized HOV lanes along the I-405 corridor surpasses that of all other study corridors. This is due to fact that the I-405 corridor is not divided into segments as is the I-5 corridor.



Figures 5.9 and 5.10 show the percentages of respondents who have, in the past, qualified to use the HOV lane but chose not to use the lanes and a list of reasons for this choice. Data for Figure 5.10 represent single instances in which respondents chose not to use HOV lanes. Respondents were asked to check all conditions that have kept them from using HOV lanes when they have been to eligible use them. These questions were modified in February 1994 to limit the time of consideration to the peak-hour periods only, but this modification had little effect on the results. As the HOV lane system is completed, it will be interesting to track opinion on these questions to see whether the travel time savings provided by longer HOV lanes attract more carpoolers.

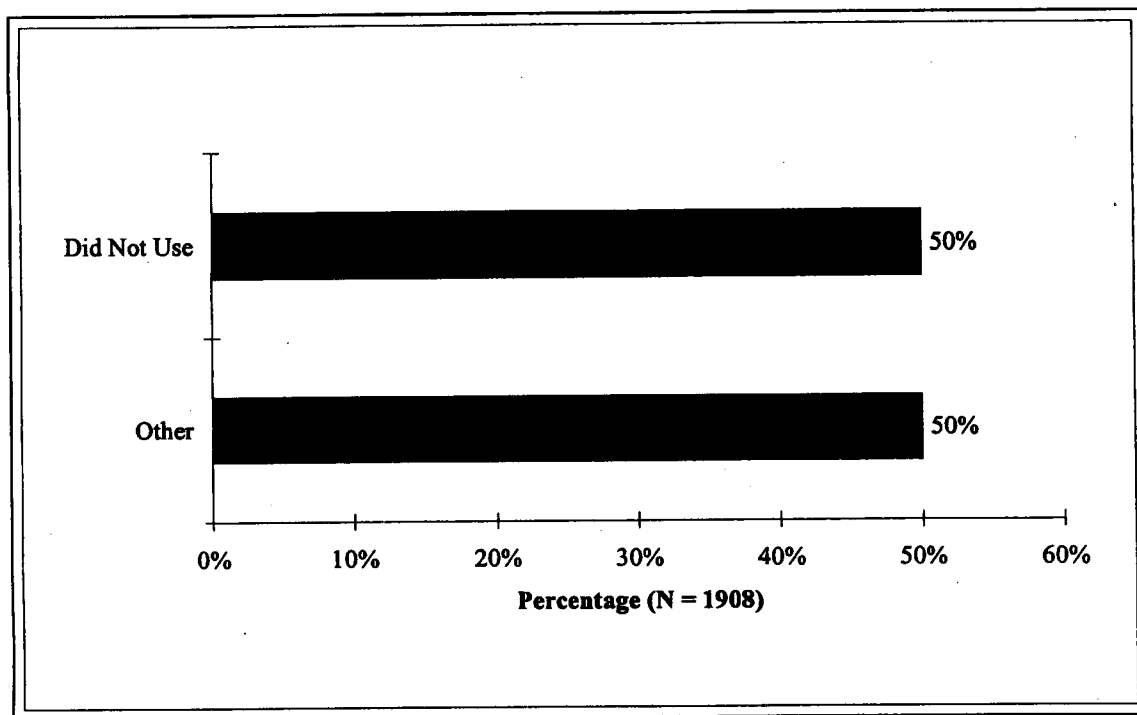

**Figure 5.9 Qualified for HOV Lane Use:** A significant number of respondents chose not to utilize HOV lanes even when vehicle occupancy requirements were met. By addressing the reasons for this choice we may be able to increase use of HOV lanes and facilitate a greater level of service for all lanes in general.

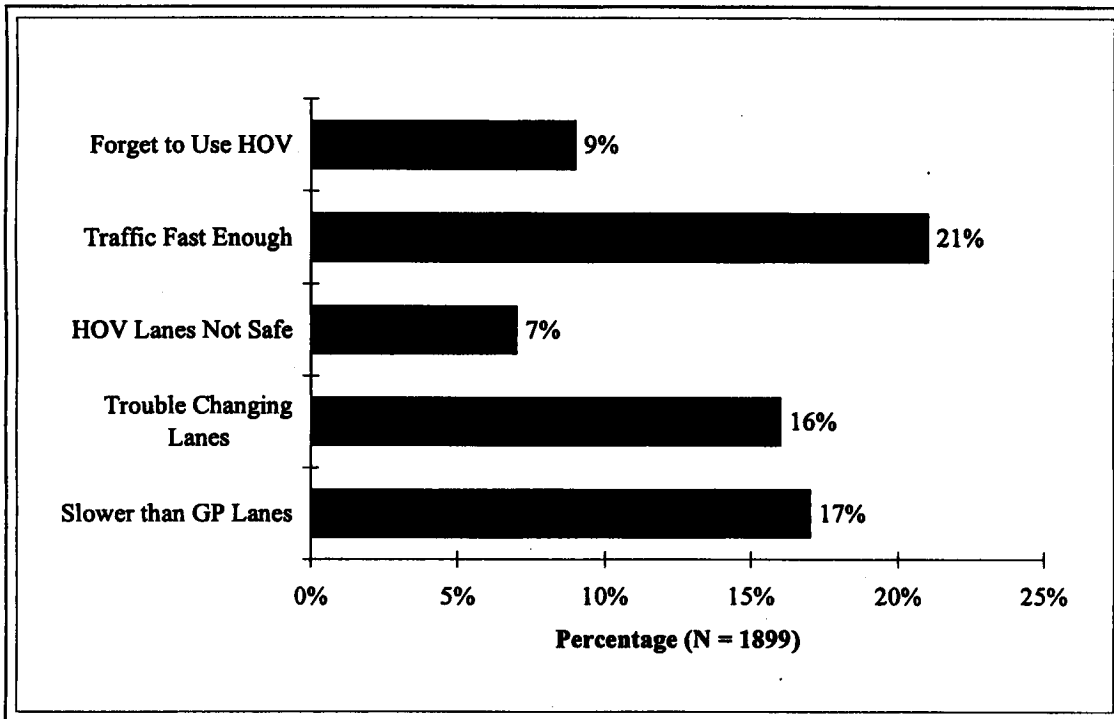
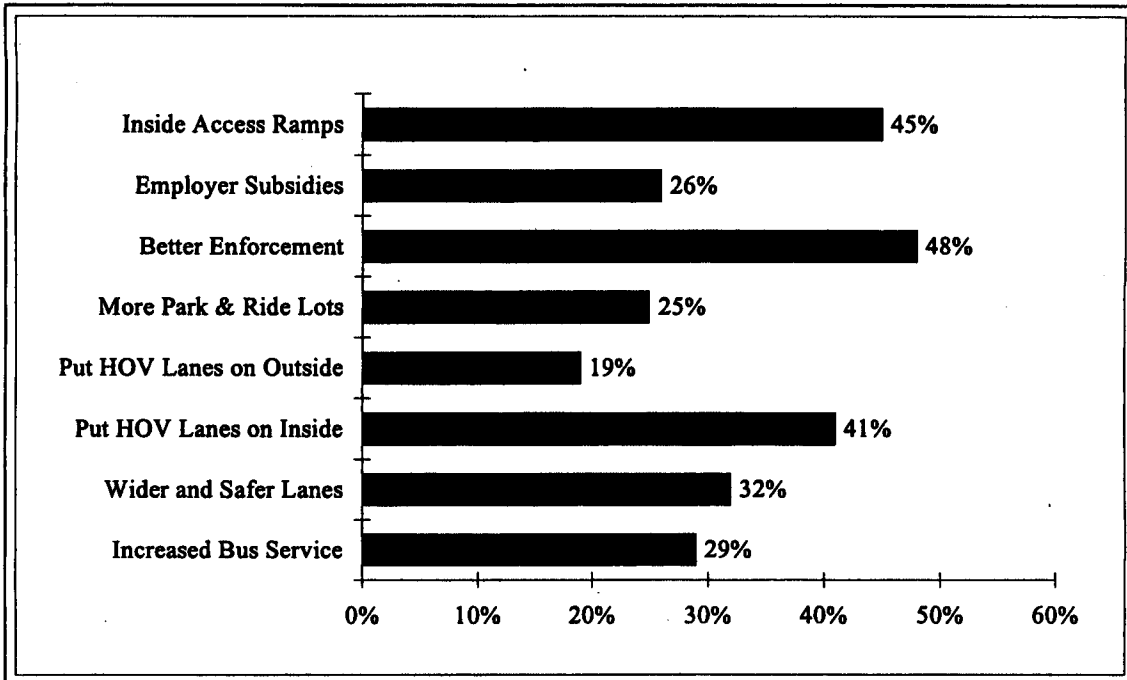

**Figure 5.10 Reasons HOV Lanes were Not Used:** Again, the selection "Traffic Fast Enough" predominates this question. First thought to be a result of the question's wording, changes made to the survey have not produced any noticeable changes in the class percentages. Obviously, when traffic moves freely, there is no compelling reason for an HOV driver to use the HOV lanes.

## **TRAVELER OPINIONS**

Figure 5.11 shows the combined HOV and SOV responses for this set of options designed to enhance the attractiveness of the HOV lanes. This question was altered in October 1995 by removing the "2+ carpool for all HOV lanes" option and adding a new "inside access ramp" option. This question was revised further in November 1995. The "Connect HOV lanes" option was replaced with an "Increased bus service" option. In addition, the "Put HOV lanes on the right" option was clarified by giving respondents the choice of either "inside" or "outside" HOV lanes as options (Figure 5.13 & Figure 5.14). Because respondents were asked to check three of seven options, the number of responses exceeds the number of overall survey responses. The distribution of responses remained consistent with that of the previous survey period, and the trends found earlier continue to exist.

The data presented in Figure 5.11 are broken down by commute mode in Figures 5.12 through 5.19. The revision to the option related to HOV lane alignment (inside vs. outside) shows respondents favoring inside HOV lanes (41%) opposed to outside HOV lanes (19%). The new "Increased bus service" option also ranked highly among respondents. A p-value, representing statistical significance, is also provided for each question. A p-value of .05 or less represents statistically significant differences of opinion between HOV and SOV groups.



**Figure 5.11 Options to Improve HOV Lane Usage:** Enforcement concerns and access issues appear to outweigh transportation demand management measures such as employer subsidies for ridesharing and additional Park & Ride lots. The issue of HOV lane configuration (right side vs. left side) is explored further in Figure 5.13 & Figure 5.14.

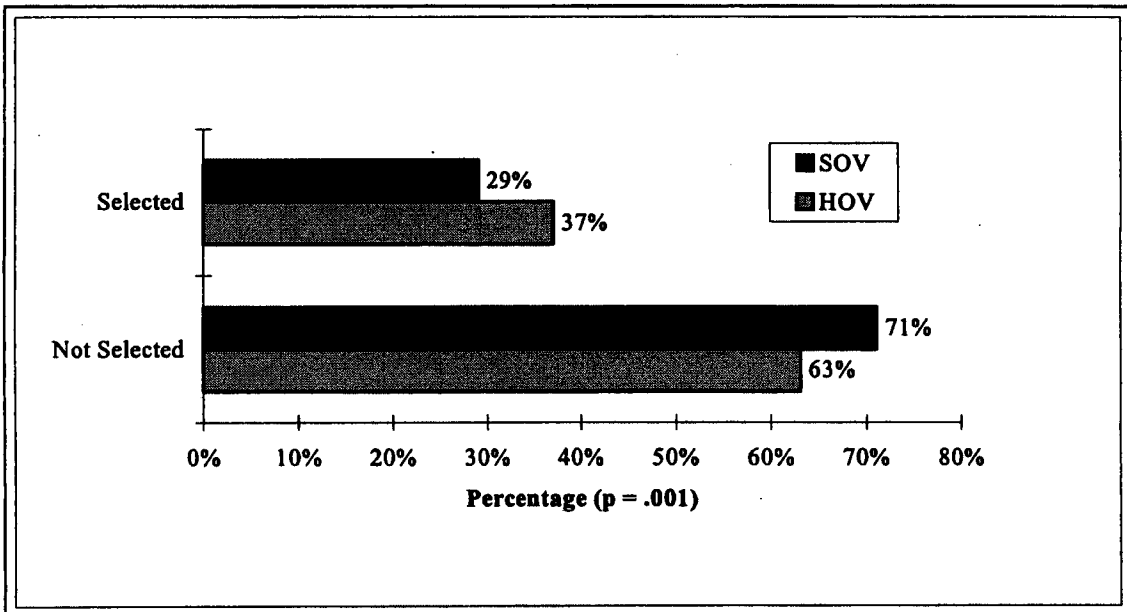

**Figure 5.12 Wider and Safer Lanes:** This option continues to gain support with both groups of drivers and is expected to rise in response to increased levels of congestion. The marginal difference between groups may be due to carpoolers having more experience with using HOV lanes.

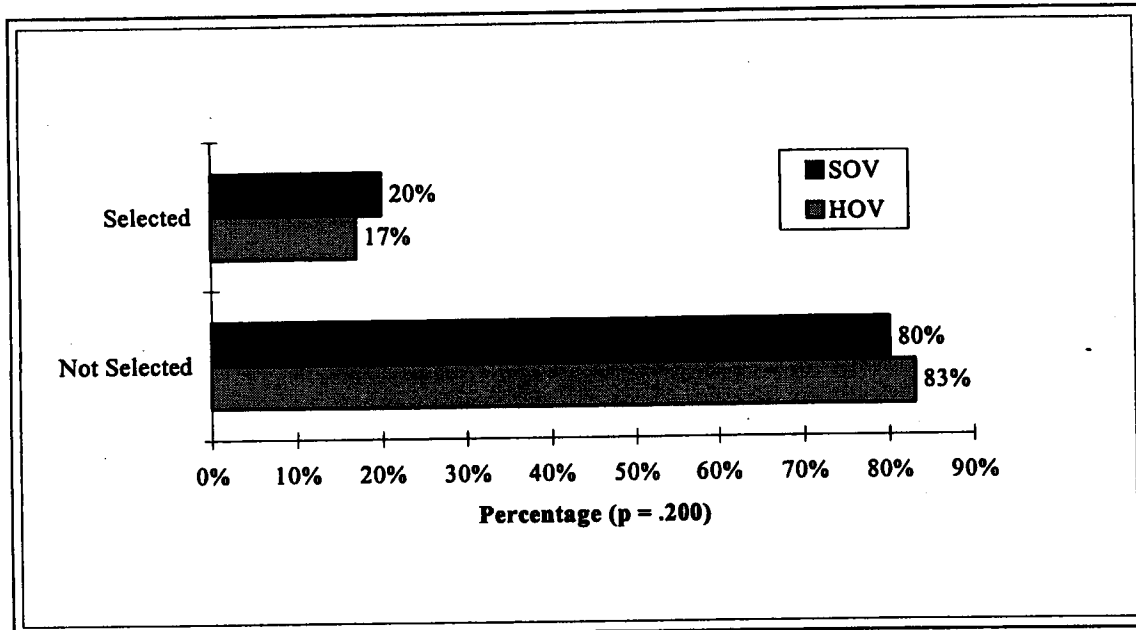

**Figure 5.13 HOV Lanes on Outside of Freeway: (See text below)**

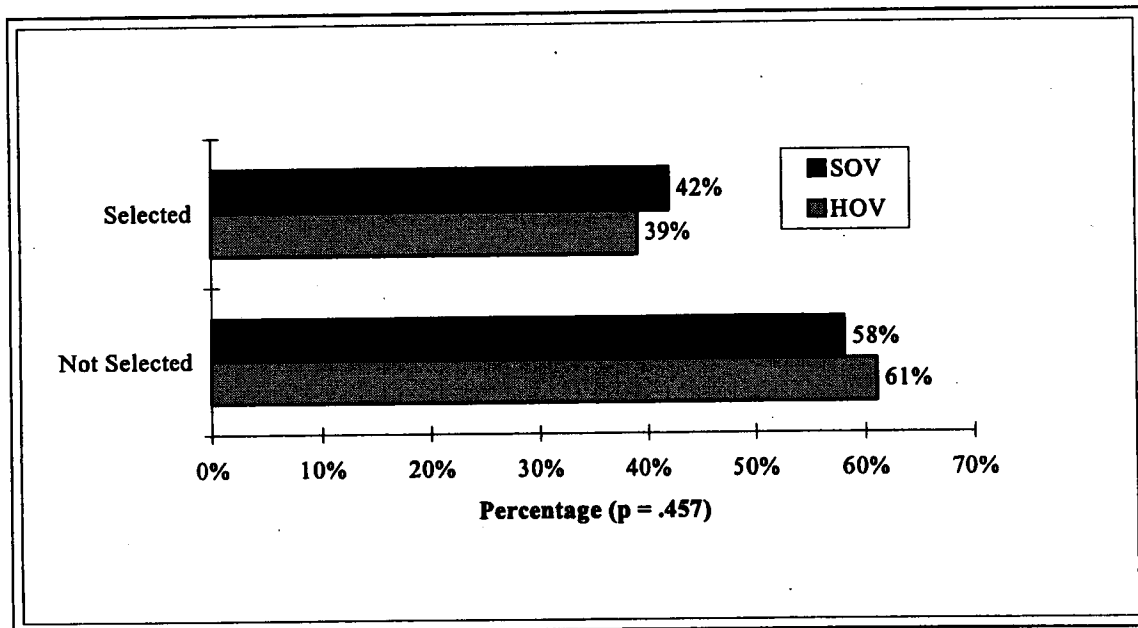

**Figure 5.14 HOV Lanes on Inside of Freeway: Respondents have clearly favored *inside* HOV lanes by a two to one margin. Please note that there is a relatively high p-value is due to the difference of opinion between the two groups.**

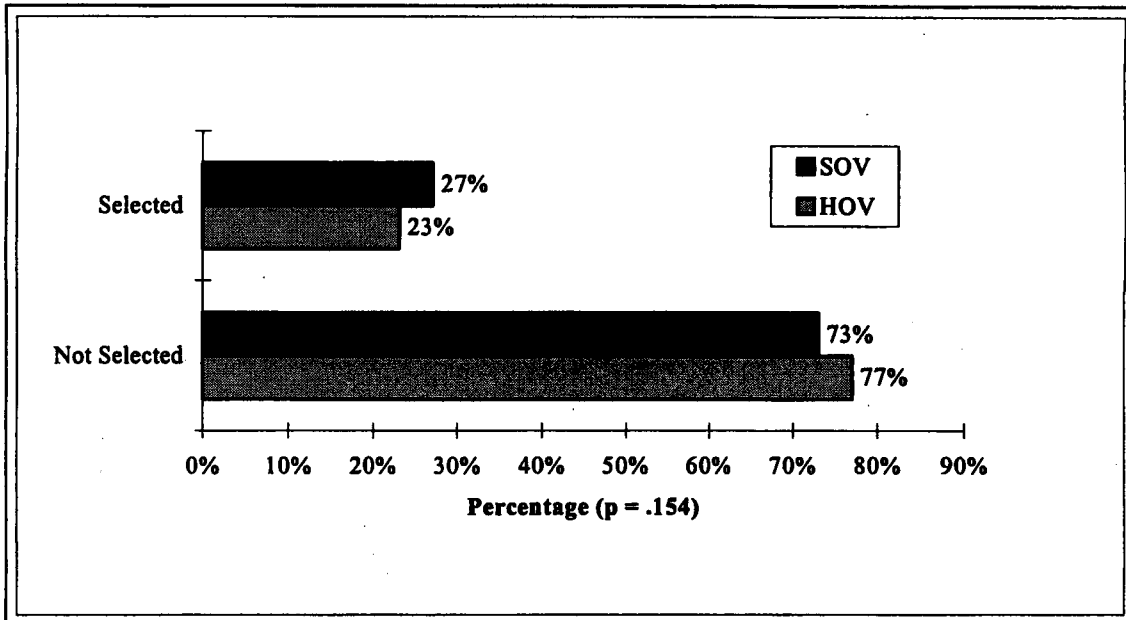

**Figure 5.15 Park & Ride Lots Near Freeway Entrances and Exits:** Support for the option has remained relatively unchanged, with SOV drivers showing slightly more support than their ridesharing counterparts. This may reflect the idea that Park & Ride lots are not as much places to assemble carpools as they are links to bus service.

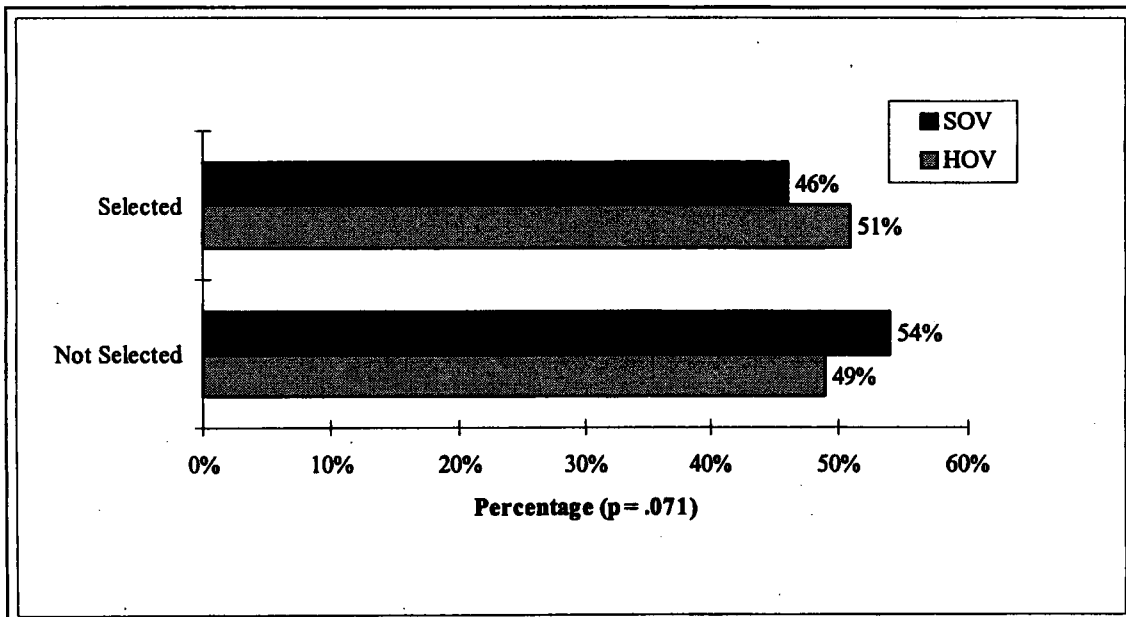

**Figure 5.16 Better Police Enforcement Against Violators:** Both groups appear sensitive to violations of the HOV system when others are observed abusing this special privilege.

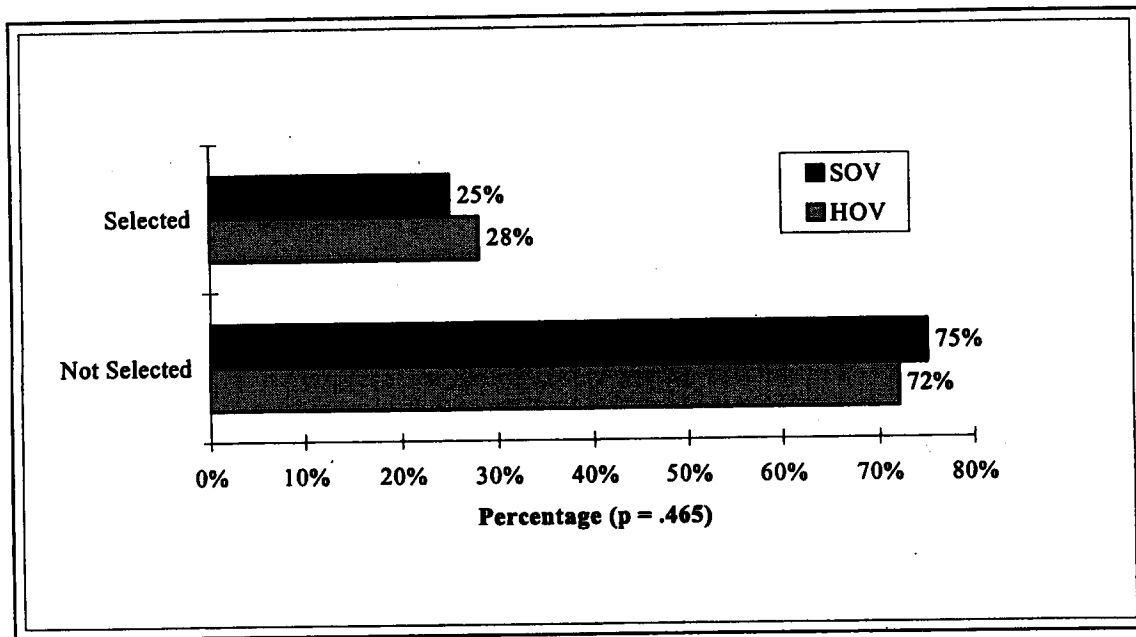

**Figure 5.17 Employer Subsidies for Ridesharing:** The low frequency of selection of this option among both groups may indicate that drivers do not feel that rideshare incentives are secondary to enforcement concerns and access issues.

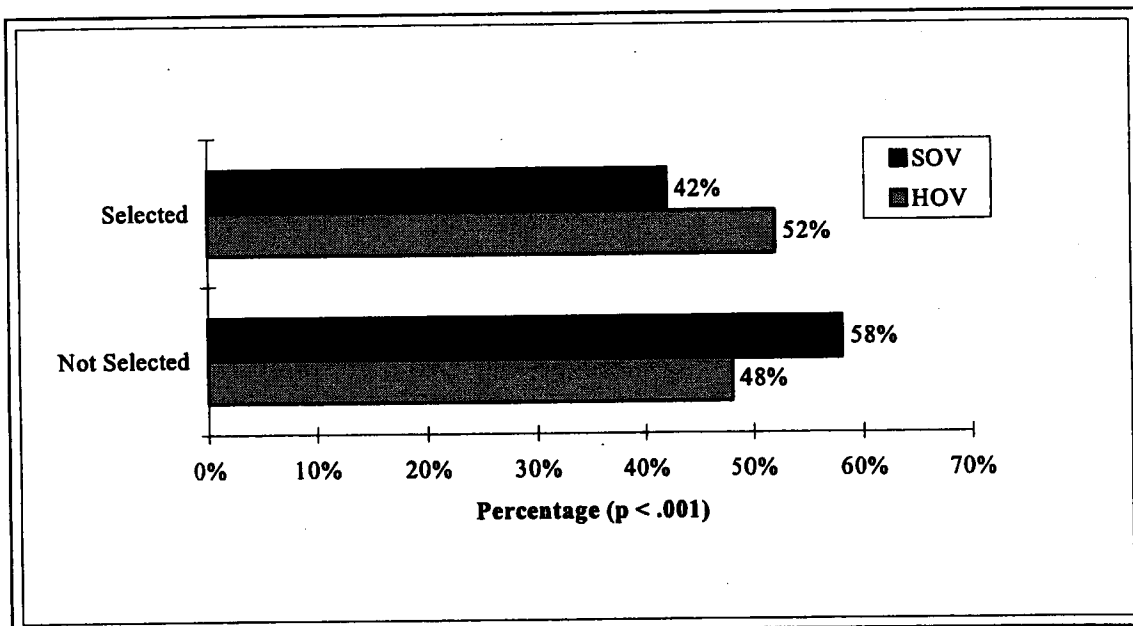

**Figure 5.18 Construct Access Ramps for Inside HOV Lanes:** This new option has fared well, ranking second overall in support among survey respondents. This favorable response may be due to the public's strong desire to continue expansion of the freeways to improve efficiency and lane capacity.

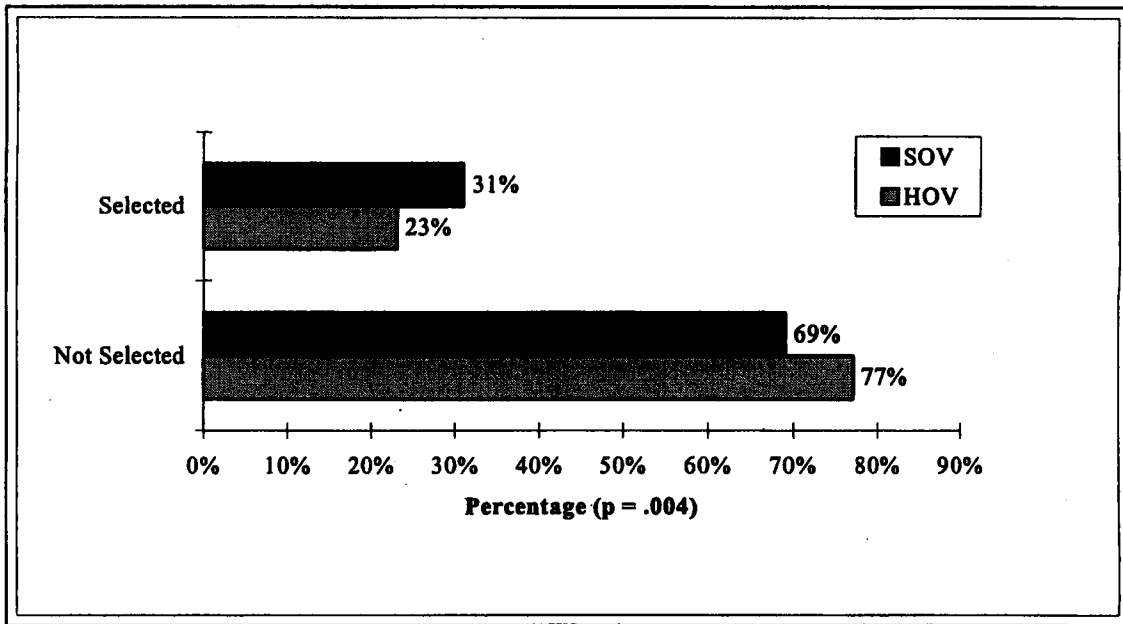

**Figure 5.19 Increased Frequency of Bus Service:** This option ranked highest among the TDM measures included with this question. However, like the “Employer Subsidies” and “Park & Ride lots” options, its overall priority did not compare with issues related to HOV lane access, enforcement, and safety.



## OPINIONS ON VARIOUS HOV LANE ISSUES

Figures 5.20 through 5.32 present data from questions about motorists' opinions on a variety of issues related to HOV lane use and effectiveness. The responses are broken down by normal commute mode and by the degree to which respondents agree with individual assertions. Sample sizes for both HOV and SOV groups are provided for each question. The exact wording of each question is provided in the figure titles.

It is important to note that in most cases, both HOV and SOV drivers tend to share the same basic opinions on issues related to HOV lane effectiveness. While both groups tend to agree in general, the differences in opinion among HOV and SOV drivers are frequently based on the degree of support for or opposition to a particular issue. These issues are accompanied by high p-values, which are based solely on the significance of the difference in opinion between the two groups. The most notable exception to this trend is when an issue concerns mode choice and the impact of HOV lanes on congestion reduction.

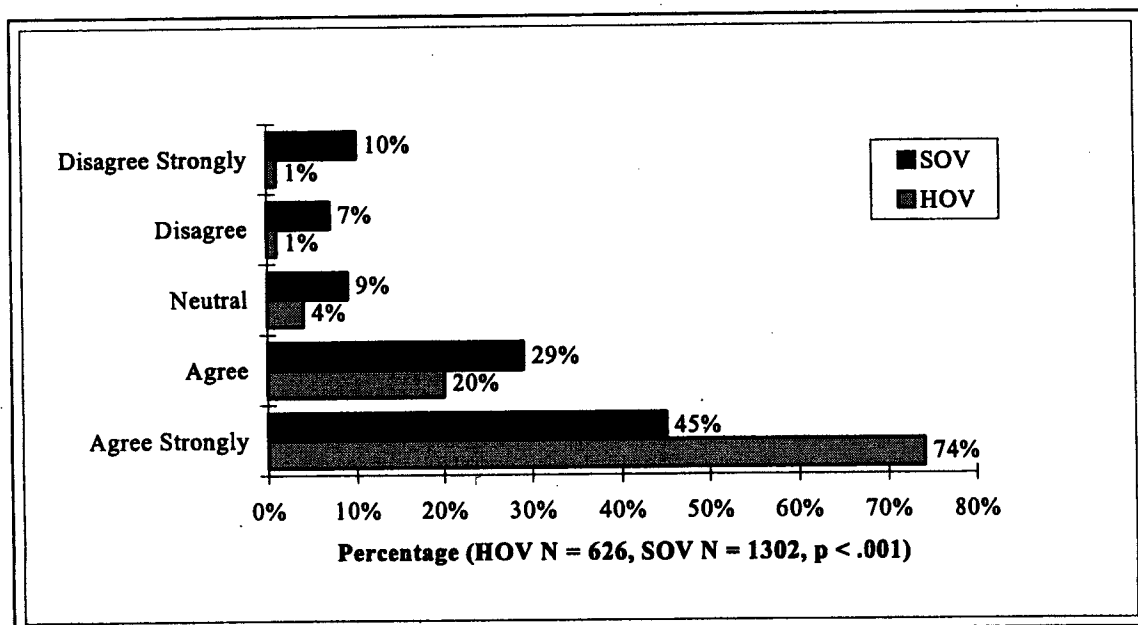

**Figure 5.20 HOV Lanes are a Good Idea:** Overall, 80 percent of drivers favor the idea of HOV lanes. Support for HOV lanes continues to be high among both SOV and HOV drivers, but support among SOV commuters has been showing signs of meager decline.

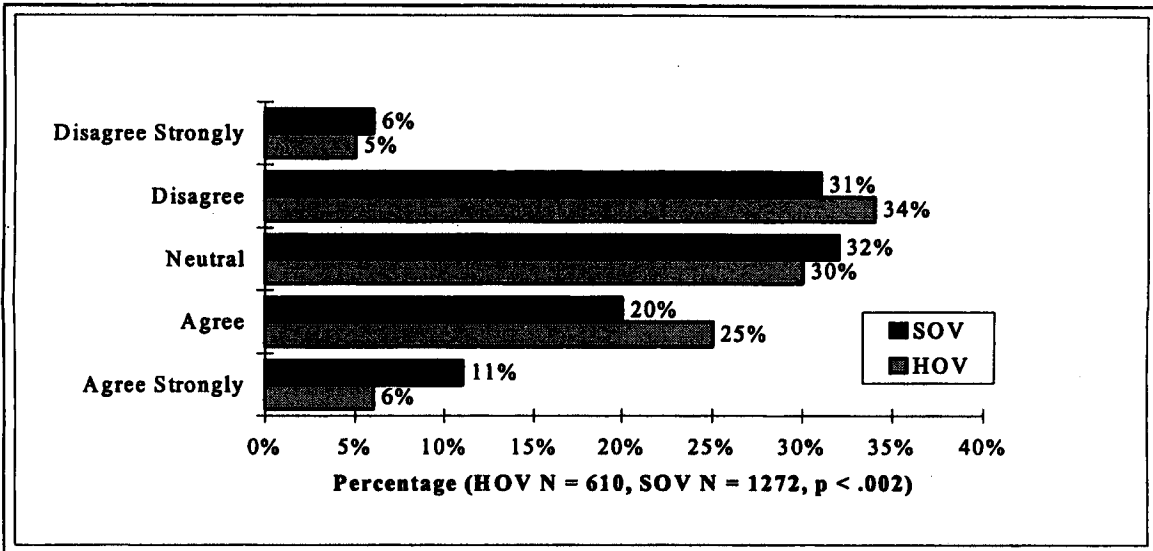

**Figure 5.21 Vehicles Dart In and Out of HOV Lanes Too Often for the Lanes to be Safe:** The opinions of both HOV and SOV drivers are similar on this issue. When the survey population is examined as a whole, opinion on this topic is neutral to slight disagreement. A divergence in opinion between groups is expected as congestion levels increase along the region’s freeway system.

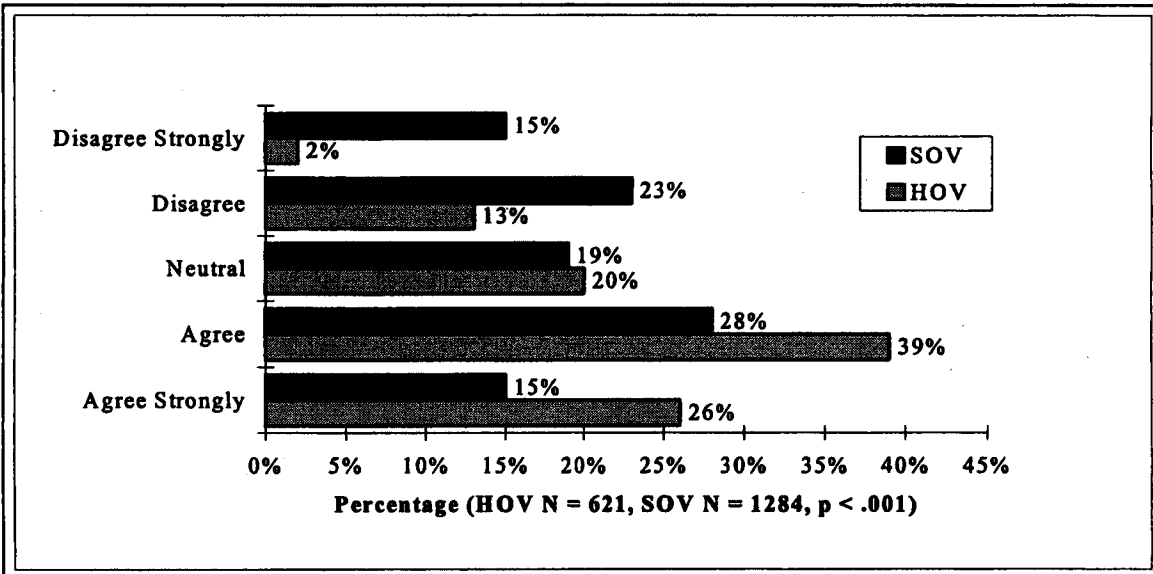

**Figure 5.22 HOV Lanes Help Save All Commuters a Lot of Time:** A highly significant difference of opinion on the travel time issue exists between the two groups. As expected, SOV user sentiment tends to be more negative as they are forced to wait in congestion bottlenecks during the peak commute period. HOV users express an inflated sense of travel time savings and may not be as sympathetic to time lost by their SOV counterparts.

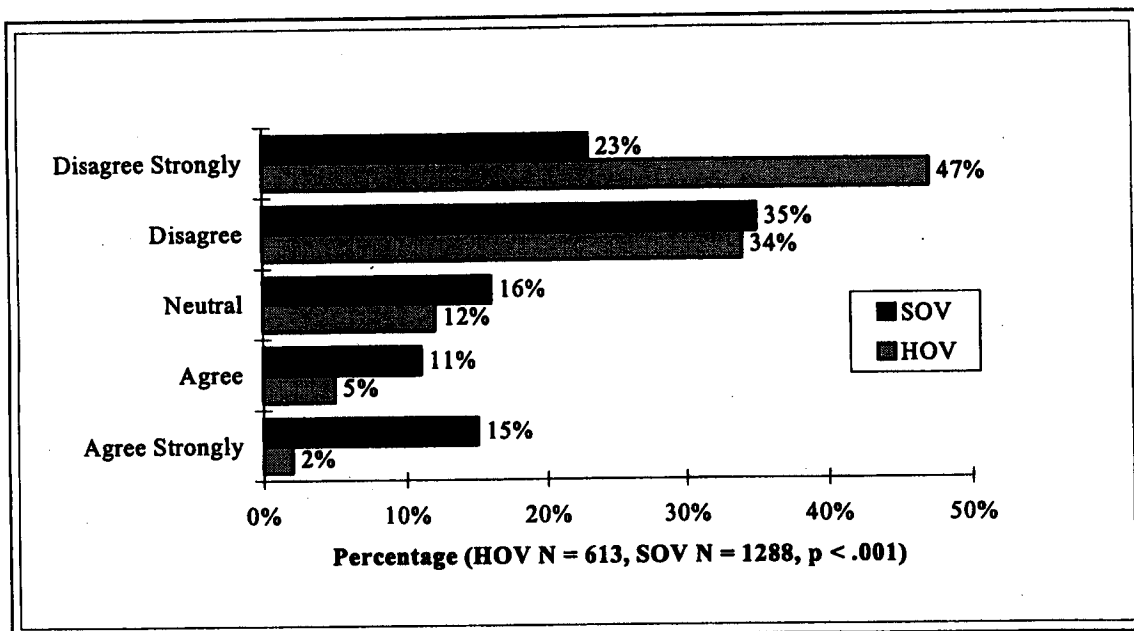

**Figure 5.23 Constructing HOV Lanes is Unfair to Taxpayers Who Choose to Drive Alone:** A majority of commuters still believe that HOV lanes are a fair use of taxpayers' money. Trends in the percentage of change show that the opinions of HOV groups continue to shift towards a united stance the HOV lanes are a valid use of taxpayers' money. SOV opinion remained consistent with previous survey results.

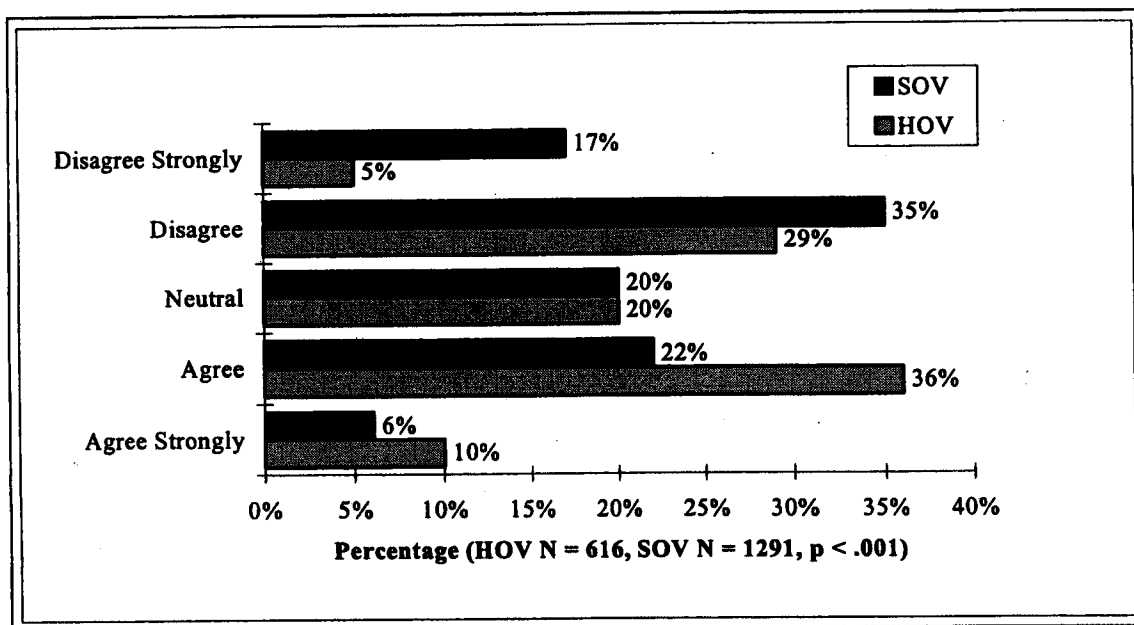

**Figure 5.24 Existing HOV Lanes are Being Adequately Used:** Overall, 46 percent of respondents disagreed that the HOV lanes are adequately used, 34 percent thought otherwise, and 20 percent remained neutral on this point.

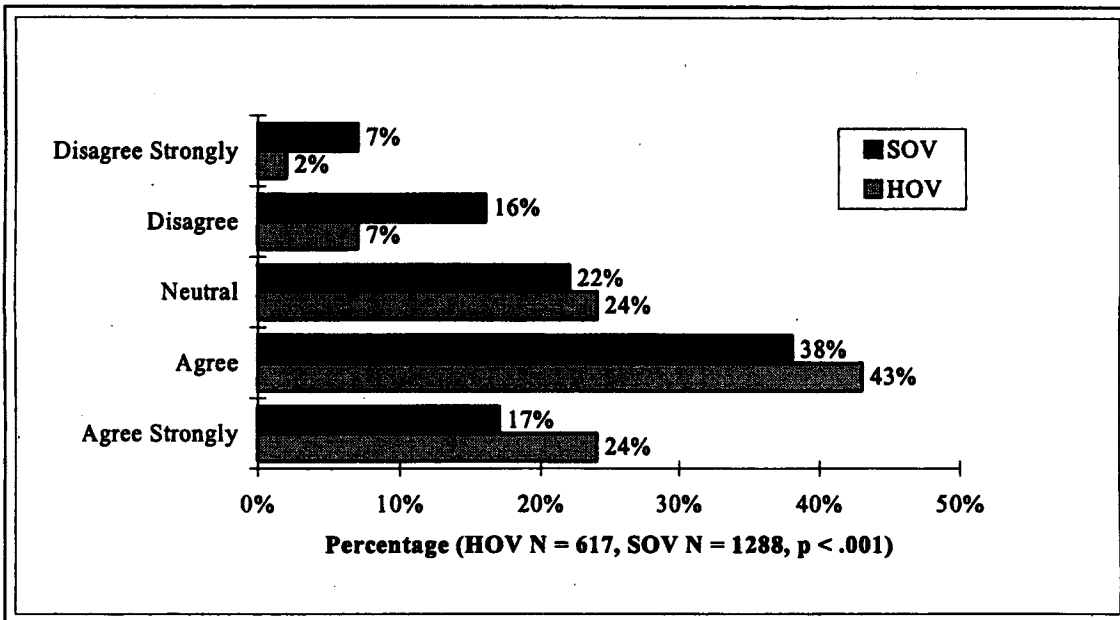

**Figure 5.25 HOV Violators Commit a Serious Traffic Violation:** These results suggest that SOV drivers tend to place a lower priority on HOV lane enforcement than do HOV drivers. Even so, both groups appear to resent the fact that HOV lane violators are unwilling to sit in traffic like everyone else.

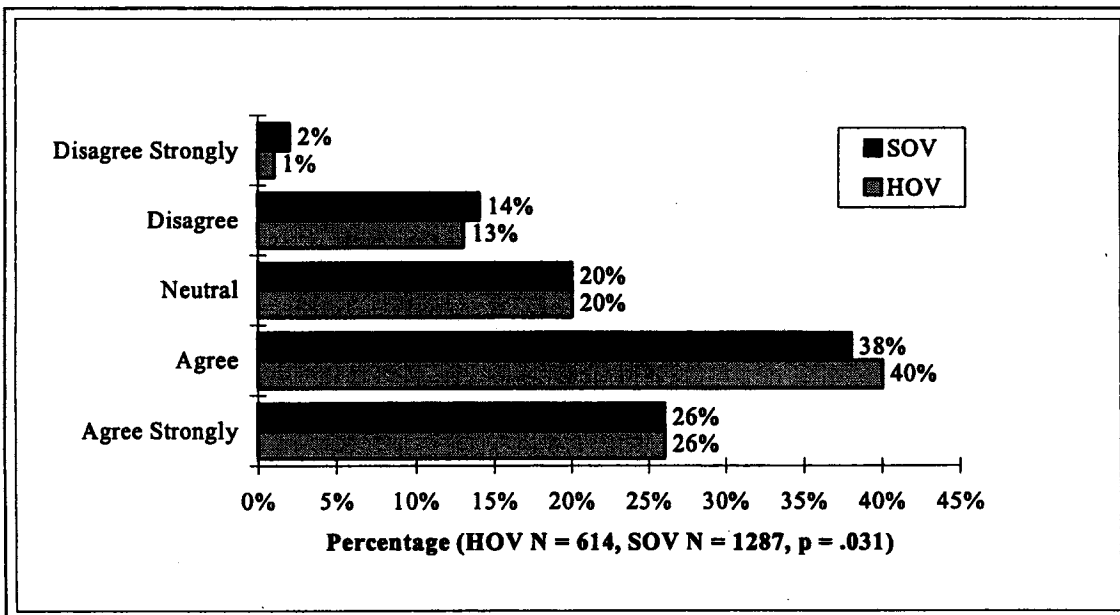

**Figure 5.26 HOV Violations are Common During the Commute Hours:** Overall, 64 percent of respondents agreed that violations are common during the commute hours. This may be why the option "Better Enforcement" was selected the best option for increasing the attractiveness of HOV lanes. (Figure 5.11)

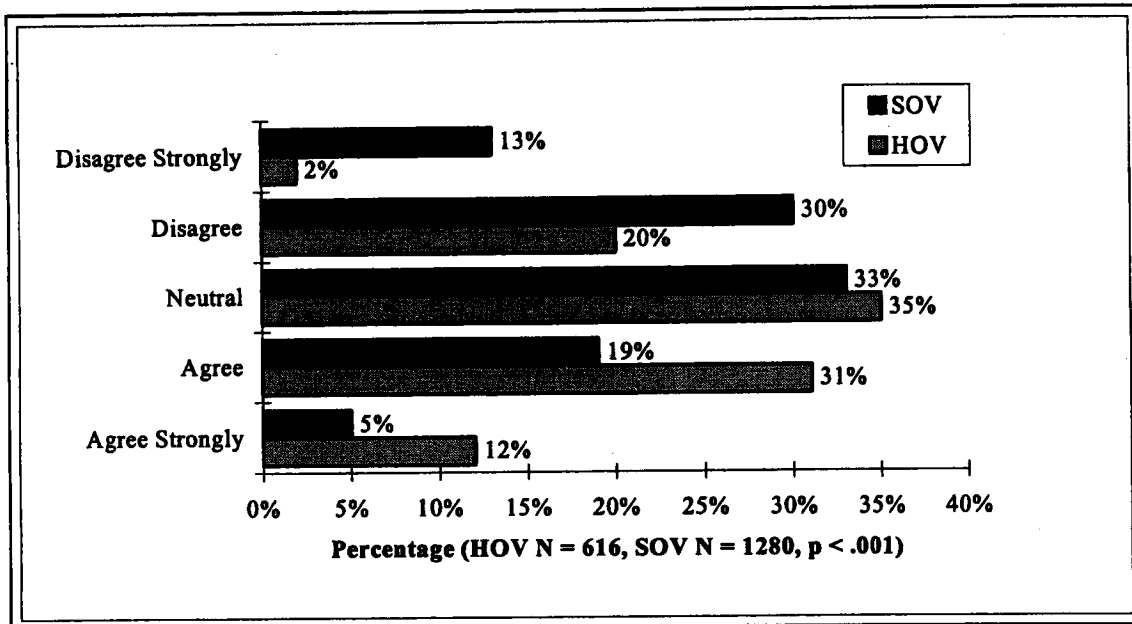

**Figure 5.27 Many More People Would Carpool if HOV Lanes Were More Widespread:** Opinions have remained consistent on this point, with some ambivalence among the population as a whole. There was a slight shift between the distribution of each group. Since the previous survey period, both types of commuters lost some assertiveness in their stance in favor of this opinion.

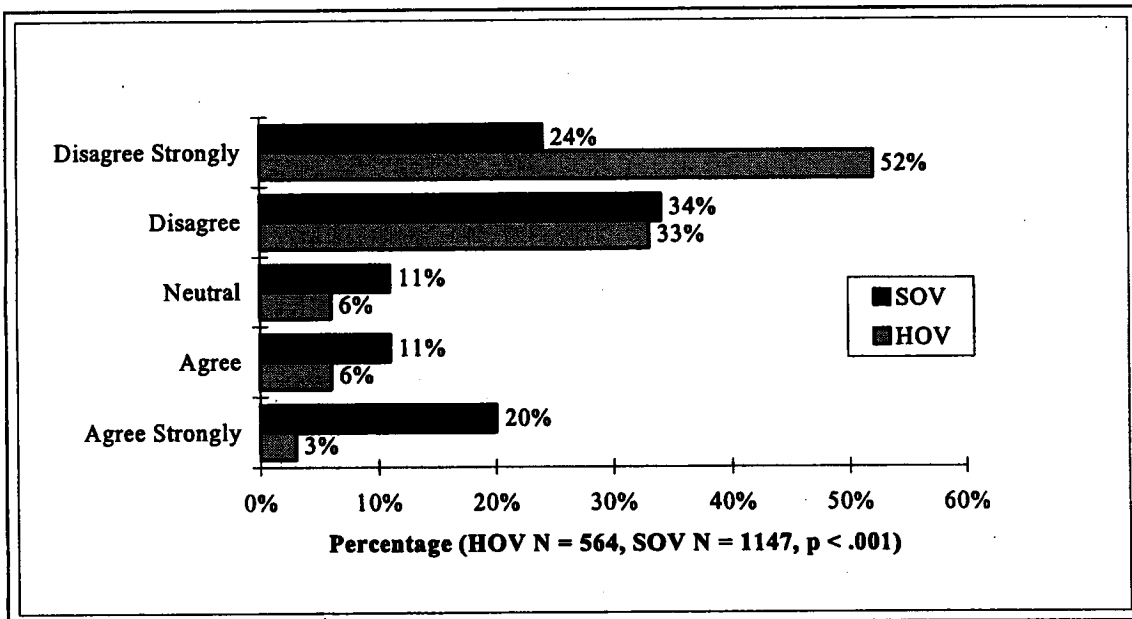

**Figure 5.28 HOV Lanes Should Be Opened to All Traffic:** The difference in opinion between groups on this issue remained the same compared to previous survey results.

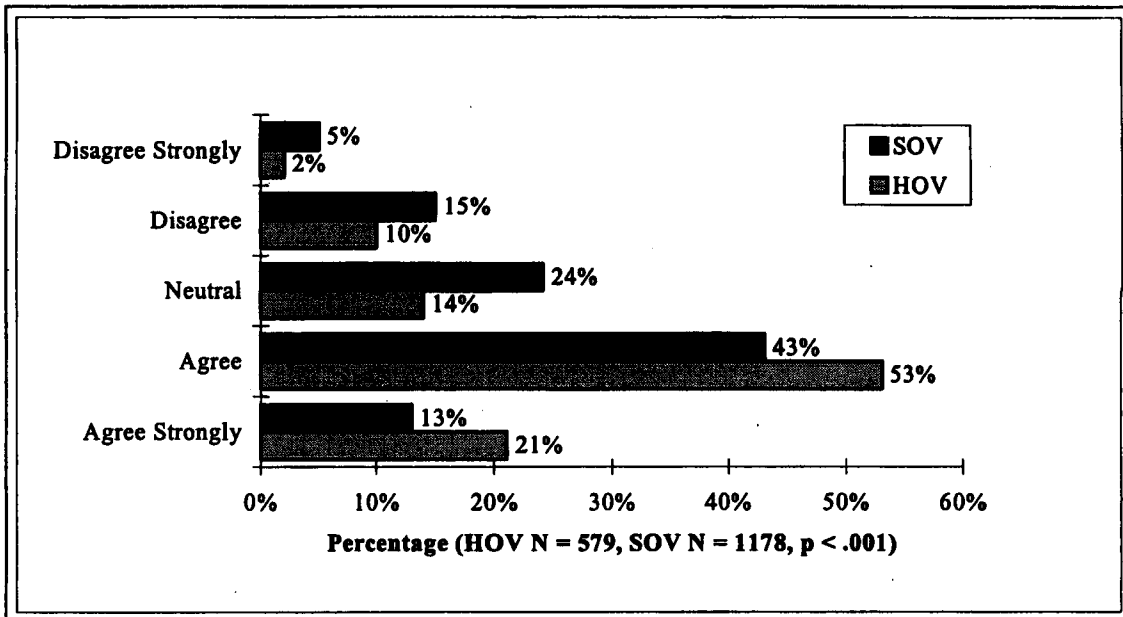

**Figure 5.29 HOV Lanes are Convenient to Use:** Again, both groups agree that HOV lanes are easy to use. As expected, HOV drivers are stronger supporters because of the fact that they are more familiar with the benefits and hazards of the HOV system.

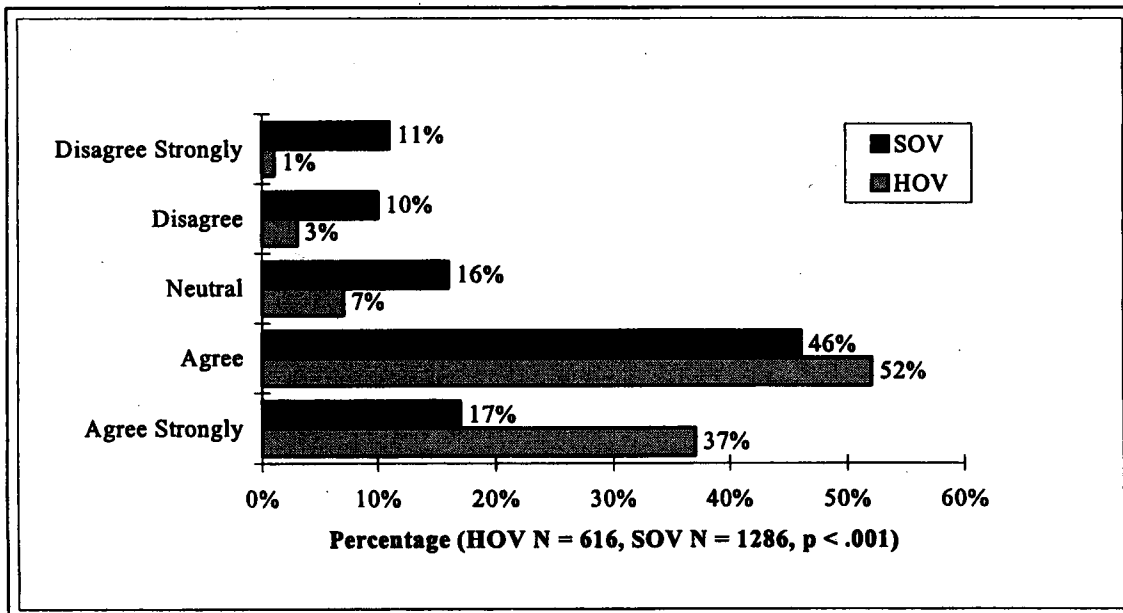

**Figure 5.30 HOV Lane Construction Should Continue, in General:** A majority of commuters continue to support the HOV lanes, with 71 percent in favor of this opinion.

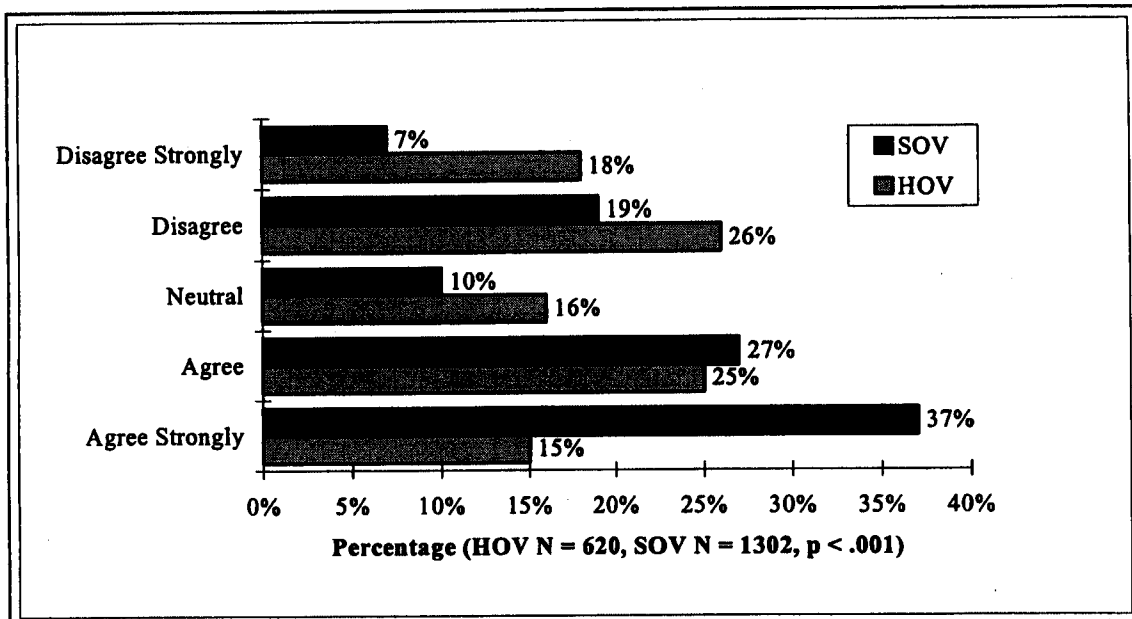

**Figure 5.31 HOV Lanes Should Be Opened to All Traffic During Non-Commute Hours:** Opinions on this option continue to vary widely. SOV users favor opening HOV lanes, with 64 percent agreeing; and HOV drivers remain undecided, with 40 percent agreeing and 44 percent against. Overall, HOV opinion tends towards keeping restrictions on HOV lanes at all times (A two percent increase over previous results).

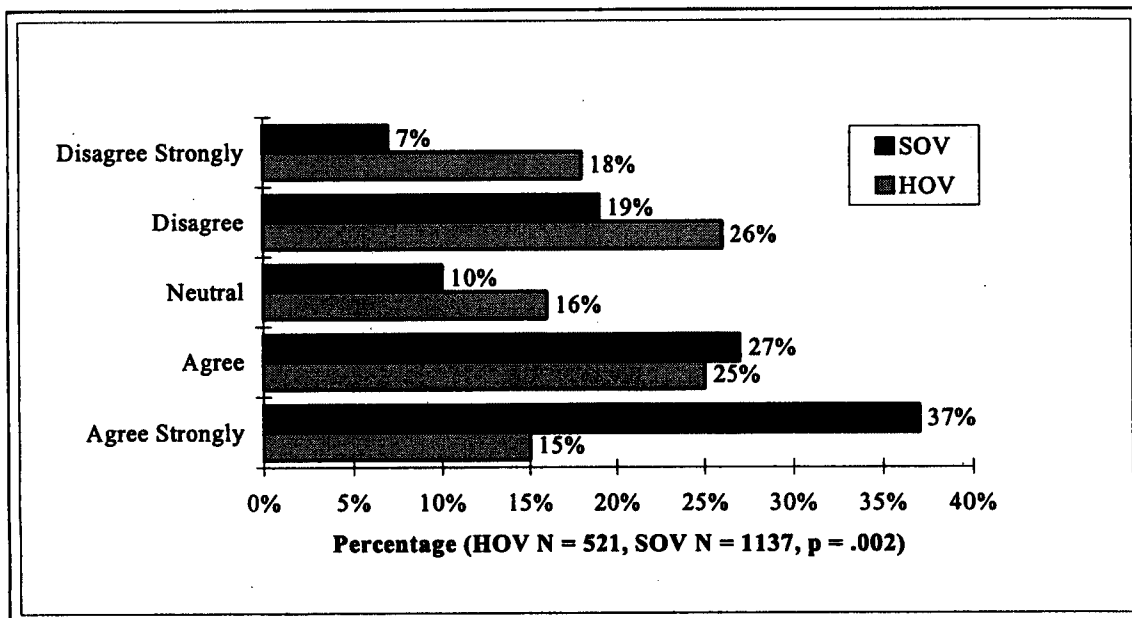

**Figure 5.32 HERO Program Helps Reduce HOV Lane Violations:** The majority of the survey respondents were neutral in their opinion of the HERO Program, with little difference between the two focal groups. Further public education may be needed to

provide commuters with a greater understanding of the important role 764-HERO plays in controlling HOV lane violations.

### **SUMMARY OF PUBLIC OPINION SURVEY RESULTS**

There is strong public support for HOV lanes in general and for future HOV lane construction. Although there are differences of opinion on many issues between SOV drivers and those who rideshare, these differences do not undermine general support for HOV lanes among the entire survey population.

One sentiment evident throughout the survey was that while the public supports HOV lanes, many people feel that the lanes are not being fully utilized. The results from questions presented in Figure 5.12 through 5.32 should assist planners in selecting the HOV lane policies that will make the lanes more attractive to the public. Results from these survey questions will be valuable in assessing the desirability of these policy options.



## **CHAPTER SIX: SECONDARY DATA SOURCES**

### **BUS RIDERSHIP ON HOV LANES**

One goal of adding HOV lanes is to increase the use of public transit by people who normally drive alone along routes that include HOV lanes. Currently, Metro (King County), Community Transit (Snohomish County), and Pierce Transit all have bus routes that use HOV lanes. It is assumed that public transit becomes more attractive to commuters as congestion increases travel times and erodes travel time reliability. Data from Metro, Community Transit, and Pierce Transit provide the basis for measuring HOV lane effectiveness in this area.

Results from the most current public opinion survey period show that 4 percent of respondents regularly commute by bus and that 11 percent have ridden on a bus that used the HOV lane. Overall, survey respondents do not appear to support incentives to increase bus ridership on HOV lanes as much as they support options that make HOV lanes more attractive to auto users (Figure 5.11). One reason that public transit improvements are not favored as much as other methods of making HOV lane use more attractive may be that the sample generated for this study consisted primarily of auto users.

### **Metro Transit Ridership**

Metro uses a statistical sampling method to measure ridership. Passenger counters are placed on a portion of the buses on each of Metro's runs. These passenger counters tally riders throughout the day. The passenger count samples generate a measure called the average daily maximum load. The average daily maximum load is then projected to the rest of the runs on the route. This measure is multiplied by the number of daily runs on that route to generate an average daily ridership estimate for a

given section of freeway. Table 6.1 shows the average weekday Metro ridership figures on area freeways.

Analysis of monthly ridership trends were not possible because of the sampling method used by Metro transit. Metro measures average daily maximum ridership for three trimesters of the year: Spring (February 15 through June 5), Summer (June 6 through August 28), and Fall/Winter (August 29 through February 12). Although these divisions allow analysis of seasonal changes in transit ridership, dividing the year in this way complicates the analysis of monthly ridership estimates. First, the divisions of the year are unequal. Using the average daily maximum load to determine monthly totals would inflate some monthly totals and depress others. Second, the accuracy of this measure is based partly on aggregation of the numbers. Disaggregation would reduce the accuracy of the estimation method. However, as an overall estimate of total ridership, the Metro model appears to be accurate.

Two major problems complicate analysis of Metro's use of HOV lanes. First, safety considerations inhibit the use of HOV lanes by Metro buses. A merge to the right into slower traffic is inherently dangerous for a bus driver. A safety guideline requires that Metro drivers begin to merge out of an HOV lane at least 2.5 kilometers before reaching a designated exit ramp. Because most HOV lanes in the Puget Sound area are located along the inside median, the difficulty of merging into an HOV lane and merging out of it soon thereafter reduce the benefit of using the lanes. The net result is that many Metro buses do not use the HOV lanes along their routes. Thus, the travel time savings associated with HOV lane use are precluded by safety concerns. As the HOV lane system is completed, Metro buses will use HOV lanes more frequently because the problem of merging into slower traffic will likely be reduced and travel time savings will increase.

Another problem is that drivers on some routes are instructed to use an HOV lane for either the inbound or the outbound portion of their trips. These problems do not affect

analysis of HOV lane use by Community Transit or Pierce Transit because the routes for both of these transit agencies are so long that HOV lanes provide significant travel time savings while posing fewer safety problems associated with merges into slower traffic.

The data in Table 6.1 show Metro ridership for routes along six of the major freeway corridors containing HOV lanes.

**Table 6.1 Average Weekday Ridership for Metro Routes Along HOV Lanes:** Metro ridership on routes that use HOV lanes or travel next to such lanes is highest in the spring, lower in fall, and lowest in summer. This trend generally holds true for Community Transit and Pierce Transit routes as well

<b>Route</b>	<b>Fall 97</b>	<b>Spring 98</b>
<b>I-5 South</b>		
@ the Duwamish River	12,700	12,900
<b>I-5 North</b>		
@ the Ship Canal Bridge	18,000	20,300
<b>SR 520</b>		
Across Lake Washington	10,000	11,000
<b>I-90</b>		
Across Lake Washington	7,400	9,200
<b>I-405 South</b>		
Coal Creek Parkway to NE 44 <sup>th</sup>	2,400	2,600
<b>I-405 North</b>		
SR 520 to NE 70 <sup>th</sup> Park & Ride lot	2,800	2,900
<b>Total</b>	<b>53,300</b>	<b>58,900</b>

Because not all Metro buses use HOV lanes, the figures overestimate true HOV lane ridership. Sifting out the routes that actually use HOV lanes from the ones that do not to generate a true ridership figure would not be financially responsible, because HOV lane use is such a small factor in Metro's route guidelines. One policy option for HOV lane planners is to build special exit ramps for HOV lanes on the inside of the freeway (commonly called "direct access/egress ramps"). One new regional agency, SoundTransit, will provide several of these direct access ramps to various city transit

centers and suburban Park & Ride lots. This option was included during the last public opinion survey period, and the results are presented in Figure 5.19.

### **Community Transit Ridership**

Community Transit supplied this project with ridership data for routes that use HOV lanes. This report includes data for the period between January 1995 and December 1997. Community Transit buses have two destinations in Seattle: the central business district (17 routes) and the University District (eight routes). These routes use the northbound and southbound HOV lanes in the I-5 North corridor and on the express lanes. Figure 6.1 compares 1997 ridership with average ridership from 1995 through 1996 to the central business district (CBD). Figure 6.2 shows the same ridership comparison for Community Transit routes to the University District. Figures 6.1 and 6.2 show the past three years of average total monthly ridership exhibiting the annual growth in Community Transit ridership along these routes. The increase in annual ridership for 1997 to the CBD averaged about 8 percent, but the University District annual ridership remained about the same as 1996 totals. Ridership to the CBD in 1997 increased by more than 250,000 riders from 1996 levels, while ridership to the University District decreased by roughly 8,800 riders for the same period. Monthly ridership in both figures is adjusted to include only weekday, non-holiday service.

Figure 6.2 Community Transit Average Daily UW Ridership 1995 - 1997: Ridership to the CBD is more stable through the year than to the University District. Downtown employees probably have a more constant need for transit over the year than do students.

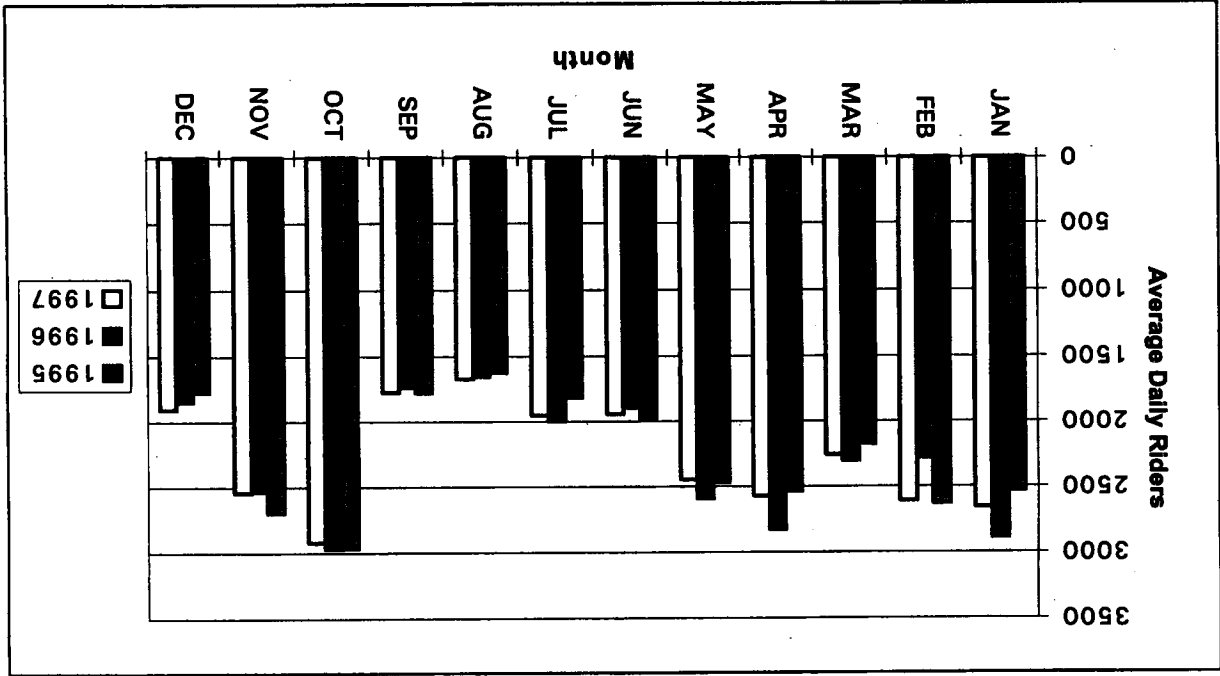
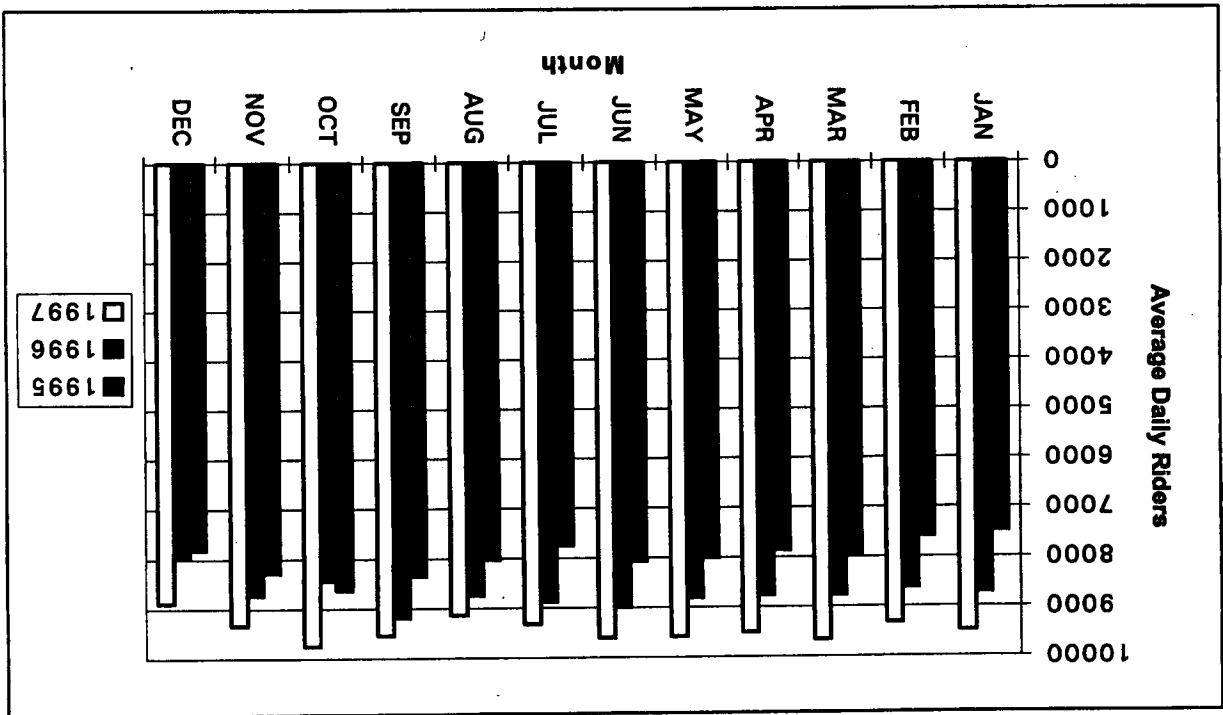
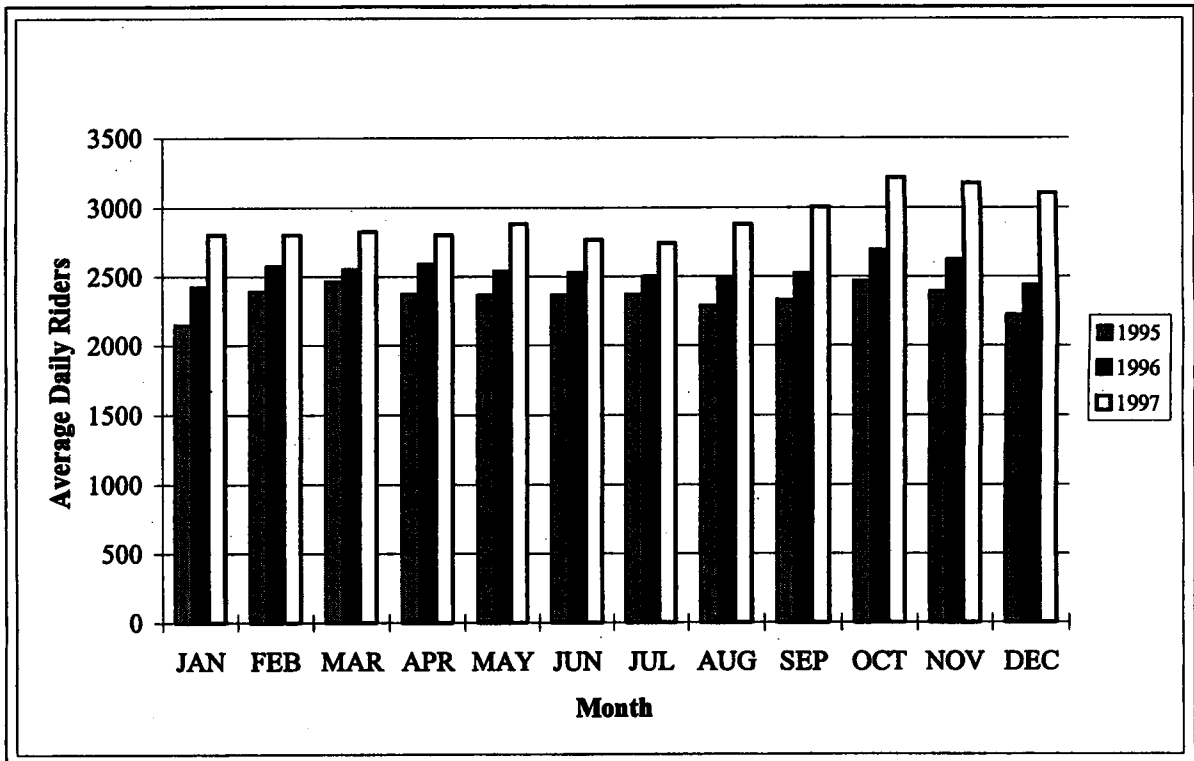

Figure 6.1 Community Transit Average Daily CBD Ridership 1995-1997: (See text below)



### Pierce Transit Ridership

Pierce Transit's Seattle Express program operates five transit routes to Seattle. This service started in September 1990. Figure 6.3 shows 1997 Seattle Express total monthly ridership in comparison to average monthly totals for 1995 and 1996. Ridership on Seattle Express buses has grown steadily. 1997 ridership was fourteen percent higher than 1996 ridership. The monthly ridership levels shown in Figure 6.3 include only weekday, non-holiday service.



**Figure 6.3 Pierce Transit Seattle Express Average Daily Ridership 1995 - 1997:** Ridership increased 55 percent since Pierce Transit took over the Seattle Express routes in September of 1994. These routes service a high proportion of the daily riders to Seattle's CBD. Transit ridership peaks in the late fall to early winter.

## **ENFORCEMENT, COMPLIANCE, AND ADJUDICATION**

Two measures of HOV lane effectiveness are (1) the violation rate of HOV lane restrictions, and (2) the outcomes of enforcement actions. We are interested in identifying trends in the number, locations, and outcomes of HOV violations. The occupancy data collected by traffic observers provides some insight into violation rates, but we have collected data from other agencies to supplement this information, such as information from the Washington State Patrol and from the HERO program, which is run by Metro. We gathered data from district courts in counties that have HOV lanes to measure HOV violation outcomes. The Washington State Office of the Administrator of the Courts supplied the data pertaining to the district courts.

In addition to these measures of HOV violations, the public opinion survey devoted four questions to motorists' perceptions of compliance and enforcement of HOV restrictions. Survey respondents ranked improving enforcement as their highest priority for making HOV lanes more attractive (Figure 5.11). About 64 percent of both HOV and SOV drivers agree that HOV violations are common during peak commute hours (Figure 5.26). In addition, about 59 percent of both groups agree that HOV violators commit a serious traffic violation (Figure 5.25). Public response to whether the HERO program helps reduce violation rates were undecidedly neutral. (Figure 5.33)

### **The HERO Program**

The HERO program is a service provided by Metro that encourages motorists to report HOV violators they observe on area highways. The HERO program encourages travelers to call in and report HOV lane violators at the telephone number 764-HERO. The HERO program office collects the license plate numbers of alleged HOV violators and sends that information to the Department of Licensing for the name and address of the vehicle's registered owner. HERO staff then send a brochure to the alleged violator, providing information on HOV lane policy and restrictions. Following a second report,

the violator receives a letter from WSDOT, issued by the HERO office, which explains that the person's auto was observed violating HOV lane restrictions. If a third violation is observed, the vehicle owner receives a letter from the Washington State Patrol (WSP), also issued by the HERO office. The HERO program does not issue tickets because the State Patrol must actually observe the violation. HERO reports repeat violators to the WSP for possible enforcement action. Figure 6.4 shows annual violation report rates for the HERO program.

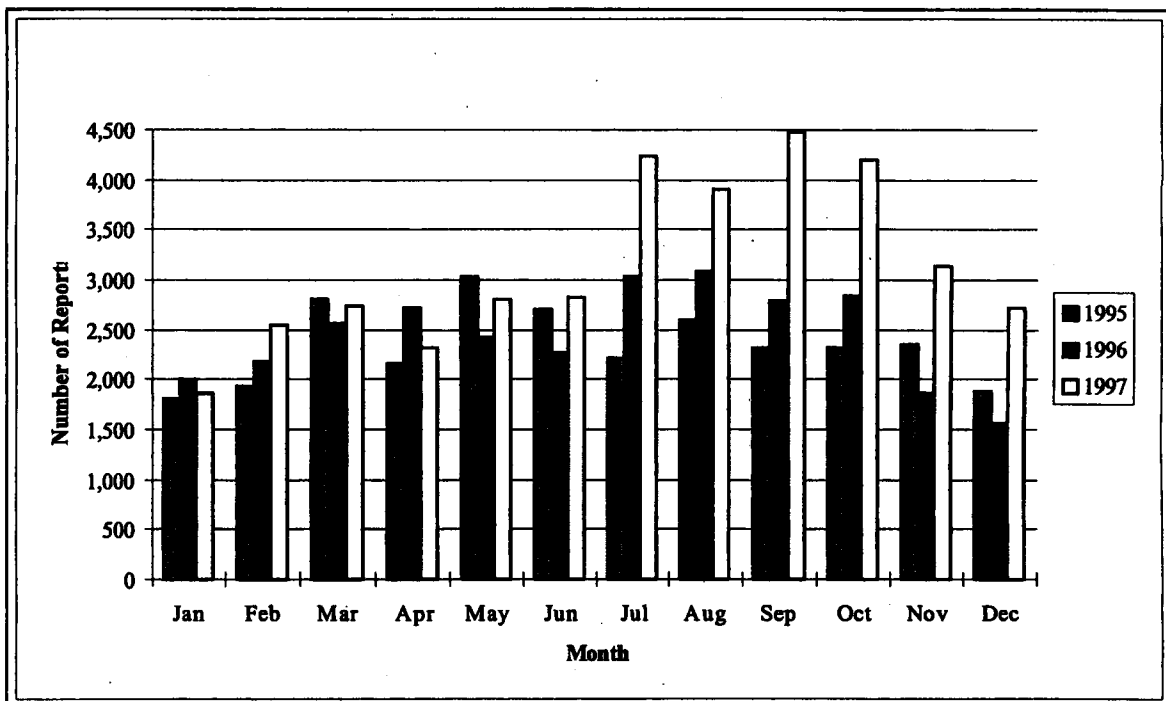

**Figure 6.4 HERO Program Actions 1995 - 1997:** Violation rates have increased steadily since 1993, with the total annual number of reported violators reaching 37785 in 1997. Reported violation rates decrease in the winter months because of diminished light levels which make it difficult to see the number of occupants or the vehicle license plate of nearby cars.



## **Washington State Patrol**

The Washington State Patrol has primary responsibility for enforcing HOV lane restrictions on state highways. While the WSP catches only a fraction of HOV violators on any single day, repeat violators have a significant chance of eventually getting caught. For 1997 the WSP reported 12,313 contacts with HOV violators and 7,014 issued tickets, for a ticketing rate of over 57 percent. This was the highest ticketing rate in the past six years. Figure 6.6 breaks down those enforcement actions by type.

**Table 6.2 Washington State Patrol HOV Enforcement Actions, 1992-1997:** The number of tickets issued by officers increased 47 percent over the previous year (1996). Troopers have the discretion to ticket offenders or to give verbal or written warnings as they see fit. WSP has adopted a "zero tolerance" policy regarding HOV violations in an effort to curb persistent violation rates.

<b>Type of Action</b>	<b>Arrest Citations</b>	<b>Verbal Warnings</b>	<b>Written Warnings</b>	<b>Accident Citations</b>	<b>Other</b>	<b>Total</b>
<b>1992</b>	3,790	3,717	248	7	21	7,783
<b>1993</b>	3,655	3,389	259	5	33	7,341
<b>1994</b>	2,809	3,159	225	N/A	11	6,204
<b>1995</b>	3,893	2,734	415	N/A	11	7,053
<b>1996</b>	4,784	5,574	327	N/A	23	10,708
<b>1997</b>	7,014	4,786	503	N/A	24	12,303

## **Adjudication Data**

While reports of violations and the number of warnings and tickets issued provides useful insight into HOV violation rates, it is also useful to know what happens once HOV violators have been ticketed. State troopers refer HOV violators to district courts in the region in which they are ticketed. Those district courts send information on the outcomes of all court cases to the Office of the Administrator of the Courts, in Olympia, for central storage and analysis. That office supplied this project with data on

outcomes for all infractions involving HOV lanes between 1991 and June 1998. The outcomes are as follow:

- Paid. Violator paid fine, no court action required.
- Committed. Violator contested ticket in court and lost, or the violator failed to appear. Failure to appear in court results in an additional fine.
- Not Committed. Court found violator not guilty.
- Dismissed. Court waived charges.
- Dismissed with Prejudice. Infraction dismissed, but court reserved right to enforce the infraction in the future.
- Dismissed without Prejudice. Infraction dismissed, and court waived the right to enforce the infraction in the future.
- Amended. Violator found guilty of a different or lesser charge.
- Pending. Case not concluded as of June 1998.

Figure 6.5 shows the outcomes for HOV violations for 1995 through 1997. Three categories (Dismissed with Prejudice, Dismissed without Prejudice, and Amended) were omitted because there were fewer than five cases in each.

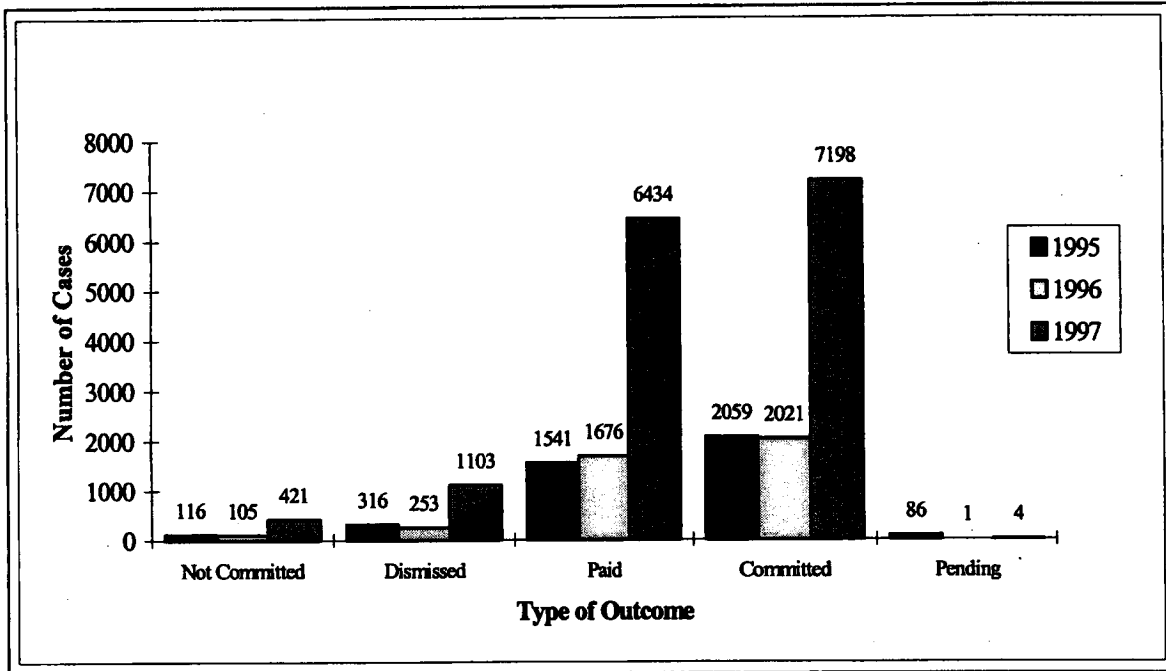

**Figure 6.5 HOV Adjudication Outcomes 1995 - 1997:** Violations committed in 1997 were up significantly from the 1995 and 1996 results.

The outcome data are also broken down by court district in Table 6.3. The results shown represent the number of cases considered for each classification in each district. Only cases from the eight most active districts are shown; all other cases are grouped under the "Other" category.

**Table 6.3 HOV Violation Outcomes by District (1997):** Drivers ticketed in most districts tend to pay the fines at roughly the same frequency (37% to 46% of tickets are paid without being contested). The convenience of appearing in court or underlying opinions about the legitimacy of HOV lane restrictions may guide those decisions. Results from the Renton district are higher than the other districts because they represent the combined caseloads of the Renton District Court and the Renton Municipal Court.

<b>District Court</b>	<b>Paid</b>	<b>Committed</b>	<b>Not Committed</b>	<b>Dismissed</b>	<b>Pending</b>	<b>Total</b>
King County: Aukeen	559	563	55	44	0	1221
King County: Northeast	1150	1278	44	310	1	2783
King County: Shoreline	351	506	1	82	0	940
King County: Southwest	404	586	17	87	0	1094
Bellevue	576	655	3	92	0	1326
Federal Way	781	868	94	70	0	1813
Issaquah	489	531	71	77	0	1168
Renton	1639	1709	128	146	3	3625
Other*	485	502	8	195	0	1190
<b>Total Cases</b>	<b>6434</b>	<b>7198</b>	<b>421</b>	<b>1103</b>	<b>4</b>	<b>15160</b>

\*Includes Everett, Tukwila, and Sea-Tac District Courts.

## **ADJUDICATION DATA RECOMMENDATIONS**

1. **Conduct a special study of repeat offenders.** Data on this subject may be available from district courts. Cross-referencing HERO data with violation outcome data may shed some light on the extent to which violators change their behavior after receiving a ticket.
2. **Conduct a special study on highway corridors characterized by chronic violation problems.** For instance, according to our ACO data, the HOV lanes on I-405 (just before the I-405/ SR 520 interchange) appear to have a very high violation rate northbound. We believe this is so because the traffic observation point is very close to where HOV lane restriction ends as the highways merge, with an HOV lane merging with two ramp access lanes from SE 8th. This configuration forces traffic from the general purpose lanes to cross the HOV lane. Even though this lane is designated for use by all traffic within the weave zone, as traffic begins to congest, motorists tend to abuse the HOV lane to bypass the congestion. One way to assess the observed violation rate would be to observe traffic at this site and simultaneously at another location 1/4 mile upstream. Follow-up conversations with WSP officials and court clerks and judges may shed light on this trend.

## **ACCIDENT INFORMATION**

WSDOT policy related to the safety of HOV lanes stipulates that HOV lanes should provide safe travel options to HOVs without having a negative impact on the safety of general purpose lanes. HOV lane safety is therefore a key determinant of HOV lane effectiveness. If drivers do not feel safe on HOV lanes, it is likely that fewer drivers

will use those lanes. While the public opinion survey measured *perceptions* of HOV lane safety, an effective evaluation also requires analysis of actual accident rates. Safety impacts of opening HOV lanes and accident trends over time are the most relevant. In addition, a safety comparison among different HOV lane configurations and policies would be useful for planning purposes.

An HOV accident is defined as an accident that occurs following an HOV lane's opening date, between the milepost markers associated with that HOV lane, and in the lane designated as the HOV lane (inside/outside). Also included in this definition are accidents that occur on the shoulder next to the HOV lane. Shoulder accidents are included because a vehicle must be in or pass through the HOV lane to be involved in a shoulder accident. This version of the *HOV Evaluation and Monitoring* report no longer contains actual data or results on accidents occurring along the HOV lanes within the Puget Sound region. This information is presented in a previous report (WA-RD 393.1), dated August 1995, which covered accident data through December 31, 1994. The following section outlines the data collection method used and the analysis process adopted to produce those results.

### **Data Collection and Analysis**

Accident data are supplied by the WSDOT Transportation Data Office. WSP and local law enforcement personnel enter data relevant to each highway accident on a standard form containing information about 90 different factors. These forms are forwarded to WSDOT. Information about 28 of the variables were of interest to this study and are available to users of these data. Beginning in 1988, the Transportation Data Office included a code on the accident data entry form to indicate whether an accident occurred in an HOV lane.

Accident data for each HOV lane were organized to correspond to the traffic observation corridors described earlier. HOV accidents as a proportion of total accidents

for each highway segment were presented; and vital statistics such as the opening date, location, lane miles, HOV lane location, occupancy requirements of each HOV lane, and HOV accidents as a percentage of all accidents were included with each figure. Lane location numbers indicated the position of the HOV lane relative to the right shoulder of the roadway. Higher lane numbers were on the inside, or left shoulder; lower numbers were on the outside, closer to the right shoulder. Any changes in the lane configuration or occupancy requirements were noted with the date of such changes. Where appropriate, data from the public opinion survey were provided to show how specific groups of drivers felt about safety on a particular HOV lane segment relative to the frequency of HOV accidents on that corridor.

Users of these data should be aware that each HOV lane opened at a different time of year. To ensure consistency across different HOV lane segments, accident data for the full first year included in each figure were provided. The accident data presented in the August 1995 report were raw numbers. The data did not represent an accident rate because accident frequencies must be compared to traffic volumes to determine absolute rates. Therefore, while an HOV lane may represent 5 percent of all accidents in a given highway segment, only one-fifth as many vehicles may use that HOV lane as use general purpose lanes. Subsequent users of these data must compare relative lane volumes to derive a valid HOV lane safety evaluation. The accident data for all locations were current through December 31, 1994.

### **ACCIDENT DATA CONCLUSIONS AND RECOMMENDATIONS**

Accident patterns are erratic throughout the region, which makes it hard to generalize about accident trends. However, some summary observations appear valid.

First, HOV lanes located on the outside, or right hand side, of the highway experience more accidents than do HOV lanes located on the inside (see SR 520 and I-405 north and southbound from Sunset to Coal Creek). The problem of merging traffic

entering the highway through the HOV lane onto the general purpose lanes probably accounts for much of this phenomenon. One factor that may account for lower accident levels in HOV lanes on the inside of the highway may be that vehicles that experience accidents while merging across the general purpose lanes on their way to the HOV lane are not counted as HOV accidents. However, valid conclusions about the relative safety of inside or outside HOV lanes depend on traffic volumes. Because traffic volumes are probably greater for HOV lanes on the outside, it is difficult to say that those lanes are less safe than inside HOV lanes.

Second, reducing occupancy requirements does not appear to significantly worsen accident rates for either HOV or general purpose lanes. In only two cases was reducing occupancy requirements associated with an increased number of accidents: I-5 northbound from the Boeing Access Rd. to Swift Avenue, and I-5 southbound from Tukwila to SR 516. However, in other areas, reducing occupancy requirements did not appear to result in significant safety problems.

The following is a recommendation for the continued use of these data.

1. Investigate the accident rates for HOV lanes on the right side of the road in comparison to HOV lanes on the left side of the road to determine which configuration is safer. Safety analysis of each configuration should be factored into future HOV lane planning.



## **CHAPTER SEVEN: CONCLUSIONS AND RECOMMENDATIONS**

This report represents a compilation of the data necessary to evaluate the Puget Sound area's HOV lane system. The data contained herein encompass vehicle occupancy, travel time, public opinion, transit ridership, and violation and adjudication. This report does not include volume information, which is available from inductance loop detectors, and accident information, which was last collected and presented in a previous report (WA-RD 393.1) dated August 1995. Inductance loop data are needed to evaluate person throughput and accident rate information; such calculations would complement the data in this report, and together they would allow for a valid evaluation of the HOV lane system.

### **AVERAGE VEHICLE OCCUPANCY CONCLUSIONS AND RECOMMENDATIONS**

Occupancy data were successfully collected from all study sites. Where data are missing, their absence is due to an insufficient number of counts or the fact that no counts were scheduled. This happened for a number of reasons, including inclement weather, poor visibility, having more sites than observers, and dropping some sites from the data collection menu. The impact of having too few successful counts per quarter was that when bad data rendered the counts unusable, data for the entire quarter were possibly lost. During the first two years of the project observations were consistently more numerous for ramp than for mainline locations, and there were more observations for GP lanes than for HOV lanes. This situation was corrected during the fourth quarter of 1994, when more HOV than GP counts were scheduled for mainline locations and more mainline counts were scheduled altogether. Starting the third quarter 1995, the total number of observations was reduced to ten counts per week because of budget cuts that reduced the funds assigned to the project. Fortunately, restoration of funding level during the current

biennium allowed the project to resume AVO and HOVTT observations at the levels called for by the project's creators.

Factors not directly explored in this report include observer performance, and observer and data management. Because observers are unsupervised in the field, they are trusted to begin and end observations on time, and to observe and record vehicle occupancies accurately. Data quality was verified by checking individual files for "gross errors" such as misnamed files and repeated entries (see *HOV Monitoring and Evaluation Tool (1)*). Quality was also validated by comparing current site data with data collected from previous observations at the same location. As the project has progressed, data have become increasingly accurate. With this in mind, the following changes are in order.

### **Recommendations**

1. **Continue to prioritize observations at locations that ensure the best use of resources.** Safe locations that provide the best visibility over varying conditions, as well as ease of access and scheduling, are obviously preferred. The question of whether counter-flow traffic patterns should be continued at existing locations or expanded at additional locations should be explored.
2. **Evaluate the appropriateness of collecting vehicle occupancy data on the I-5 express lanes.** Because the express lanes contain both HOV and GP lanes, "before" data for this corridor may be useful in areas where express lane expansion is planned, and they would allow planners to monitor the express lanes' performance.

The occupancy data presented in this report provide valuable information in two areas: (1) the operation and performance of HOV lanes in comparison to GP lanes, and (2) commuter mode choice in the greater Seattle area. Additionally, as the HOV lane

system expands, areas where "before" data have been collected will serve as baseline reference points in assessing the impact of HOV facilities on commuter mode choice. However, a caveat is in order: because loop data are more representative of traffic volumes in these corridors, the data included in this report should be used only to indicate the percentages of mode and vehicle occupancy in the corridors studied.

### **ACO ANALYSIS CONCLUSIONS**

Many factors affect ACO. Therefore, it is important to use a sampling frame that reduces the influence of these factors. However, because it is impossible to perfectly sample all time periods, days of the week, lanes, and ramps at each location for the whole year, it is important to take these factors into account when changes in ACO are analyzed.

After several years of data collection, we have some understanding of these differences. However, if one is conducting such detailed analysis, it is better to apply correction factors (see Chapter 3) than to use the raw data without adjustments.

### **BASELINE TRAVEL TIME AND HOVTT (FCM) DATA CONCLUSIONS AND RECOMMENDATIONS**

The usefulness of the baseline (license plate matching method) travel time data presented in this report is limited. Although the data can generally be used to compare HOV lane performance to GP lane performance and to identify areas of congestion, a number of factors render data interpretation difficult. Vehicle speeds can only be compared by time of commute for the quarter in which they occurred. Because the data are presented as average speeds, only individual study sections may be used; the data cannot be aggregated to examine the differences between HOV and GP lanes corridor-wide. Because the speeds indicated for areas tend to vary widely from quarter to quarter, yearly averages are unreliable. To determine the number of observations required for

statistically meaningful information, the standard deviation for each time period must be established. Additional data will be necessary before reliable generalizations regarding vehicle speeds can be made.

It was much more difficult and complex to collect baseline travel time data than it was to collect vehicle occupancy or travel time data using the floating car method. Observers not only had to be more accurate and have better visibility, they also had to coordinate their efforts more carefully. Even with good data, matches were difficult to obtain because of normal traffic behavior (e.g., lane changes), especially over long distances. Despite the obstacles that made it difficult to collect the baseline travel time data, the experience gained in this study indicates that travel time data may be collected successfully under some conditions. The greatest volume of baseline travel time data was gathered at study sections characterized by good visibility, short length, and high numbers of observations.

### **Recommendations**

1. **Use short study sections.** Distances between sites should be kept to under three kilometers and should be chosen to limit the number of intervening access/egress ramps.
2. **Conduct observations using the express lanes.** Not only do the express lanes have GP and HOV designations, they also constitute a "captive audience" in that vehicles may not exit for longer distances. As a result, it may be easier to obtain the necessary matches.
3. **Data collection along the I-405 corridor should cover shorter distances and use fewer locations.** For example, efforts might be more successful if observations were limited to two study sections (Tukwila Parkway and Benson Road S; 112th

Avenue SE and NE 12th Street) for morning northbound and evening southbound commutes.

Effective collection of baseline travel time data requires a great deal of coordination between observers to ensure that they begin and end at the same time, as well as corridor sections that facilitate license plate matches. Even when travel time data are effectively collected, they can vary so much that routinely gathering data to establish an "overall" travel time statistic for a length of corridor may not be very useful. Because of this fact, future travel time data will be collected by means of the floating car method discussed in Chapter 4. The following recommendation is proposed to better facilitate the collection of HOVTT (fcm) travel times.

4. Index funding for data collection efforts with the addition of HOV lanes miles. Maintaining current HOVTT (fcm) and ACO data collection for all sites originally observed during the baseline data collection period is required to evaluate the effect HOV lanes have on regional traffic patterns. Additional support will be required from associated agencies to obtain significant samples of data for HOV lane evaluations.

It is important to maintain levels of data collection so that time-based trends are not missed because of insufficient data. To maximize the project's resources, HOVTT (fcm) travel time data will be collected during the first and fourth quarters of each year, when limited light conditions make ACO data collection less reliable.

## **PUBLIC OPINION SURVEY CONCLUSIONS**

There is strong public support for HOV lanes in general and for future HOV lane construction. Although there are differences of opinion on many issues between SOV drivers and those who rideshare, these differences do not undermine general support for HOV lanes among the entire survey population.

One sentiment evident throughout the survey was that while the public supports HOV lanes, many people feel that the lanes are not being fully utilized. The results from questions presented in Figure 5.12 through 5.32 should assist planners in selecting the HOV lane policies that will make the lanes more attractive to the public. Results from these survey questions will be valuable in assessing the desirability of these policy options.

### **Recommendations**

1. **Conduct periodic reviews of the survey to ensure the appropriateness of its content.** Interest in various issues related to the HOV lanes change frequently. Therefore, the survey needs revisions periodically so that planners have data on public sentiment towards new HOV lane issues.

## **ENFORCEMENT DATA CONCLUSIONS AND RECOMMENDATIONS**

The ACO data, violation data from WSP, HERO program data, and adjudication data from the district courts provide a comprehensive picture of the extent of HOV violations in the Puget Sound area. Violation rates would be the most appropriate measure for evaluation purposes because they combine the number of cars using an HOV lane with the frequency of violations. Identification of the HOV lanes with the highest violation rates would provide valuable information to WSP troopers for their enforcement efforts. The ACO data presented in Appendix B provide an indication of violation rates (the number of SOVs observed in HOV lanes). Both WSP troopers and district court

judges exercise a great deal of discretion in enforcing HOV lane violations. If WSDOT or other public officials desire to increase enforcement of HOV lane restrictions, consultation with these groups is in order.

### **Recommendations**

1. **Conduct a special study of repeat offenders.** Data on this subject may be available from district courts. Cross-referencing HERO data with violation outcome data may shed some light on the extent to which violators change their behavior after receiving a ticket.
2. **Conduct a special study on highway corridors characterized by chronic violation problems.** For instance, according to our ACO data, the HOV lanes on I-405 (where SR 167 merges with I-405) appear to have a very high violation rate. We believe that this is so because the traffic observation point is very close to where the highways merge, with a general purpose lane merging into an HOV lane on I-405. One way to assess the violation rate would be to observe traffic at that spot and at another spot one-quarter mile downstream simultaneously. Follow-up conversations with WSP officials and court clerks and judges may shed light on this trend.

### **ACCIDENT DATA CONCLUSIONS AND RECOMMENDATIONS**

Accident patterns are erratic throughout the region, which makes it hard to generalize about accident trends. However, some summary observations appear valid.

First, HOV lanes located on the outside, or right hand side, of the highway experience more accidents than do HOV lanes located on the inside (see SR 520 and I-405 north and southbound from Sunset to Coal Creek). The problem of merging traffic

entering the highway through the HOV lane onto the general purpose lanes probably accounts for much of this phenomenon. One factor that may account for lower accident levels in HOV lanes on the inside of the highway is that vehicles that experience accidents while merging across the general purpose lanes on their way to the HOV lane are not considered HOV accidents. However, valid conclusions about the relative safety of inside or outside depend on traffic volumes. Because traffic volumes are probably greater for outside HOV lanes, it is difficult to say that those lanes are less safe than inside HOV lanes.

Second, reducing occupancy requirements does not appear to significantly worsen accident rates for either HOV or general purpose lanes. In two cases, reducing occupancy requirements was associated with an increased number of accidents: I-5 northbound from the Boeing Access Rd. to Swift Avenue, and I-5 southbound from Tukwila to SR 516. However, in other areas, reducing occupancy requirements did not appear to cause significant safety problems.

### **Recommendation**

1. **Investigate the accident rates for HOV lanes on the right side of the road in comparison to HOV lanes on the left side of the road to determine which configuration is safer.** Safety analysis of each configuration should be factored into HOV lane planning.



## **ACKNOWLEDGMENTS**

The authors gratefully acknowledge the following agencies for the information they provided:

- Metro, for transit ridership and HERO data
- Community Transit, for transit ridership data
- Pierce Transit, for transit ridership data
- the Washington State Administrator of the Courts, for adjudication data
- the Washington State Department of Transportation, Traffic Data Office, for accident data
- the Washington State Patrol, for violation and accident data.

The authors also express their appreciation to TRAC staff, including Duane Wright, Ron Porter, Amy O'Brien, and Stephanie MacLachlan for their assistance in formatting the numerous tables and diagrams, as well as editing the body of this report. Eldon L. Jacobson, WSDOT--Advanced Technology Branch; Barbara Miller and Patrick Purvus, former Observations Managers; Graciela Etchart, Matthew Hansen, and Matthew Benuska, the authors of the original report (1); and the late Cy Ulberg, the principal investigator, were valuable resources. Finally, this report is dedicated to the traffic observers. Through many hours spent counting cars in all kinds of weather, they provided much of the data, without which this report would not have been possible.

## REFERENCES

1. Ulberg, Cy, Matthew Benuska and Matt Hansen. *HOV Monitoring and Evaluation Tool*. Olympia, Washington: Washington State Department of Transportation. WA-RD 318.1, 1993.
2. Ulberg, Cy, and Edward McCormack. *Auto Occupancy Monitoring*. Olympia, Washington: Washington State Department of Transportation. WA-RD 157.1, 1988.
3. \_\_\_\_\_, *Washington State Freeway HOV System Policy, Executive Summary*. Olympia, WSDOT, 1992 (November).
4. Personal communication, Barbara Miller (HOV Monitoring and Evaluation Observations Manager, July 1992 - June 1993), November 24, 1993.
5. Brown, William W. *HOV Travel Times (by Floating Car and Community Transit AVI Methods)*. Seattle: Washington State Transportation Center (TRAC), April 1996.

**APPENDIX A**

**ACO and Travel Time Observation Sites**

**Table A1 Observation Sites: Beginning Date & Characteristics**

Corridor	Location	Date	Mainline	HOV	Ramp	Travel Time
<b>I-5 North</b>						
	236th St. SW	7/28/92			X	X
	NE 185th St.	7/1/92				X
	NE 175th St.	6/22/92			X	
	NE 145th St.	6/22/92	X	X	X	
	NE 117th St.	6/25/92				X
	NE Northgate Wy.	6/25/92			X	
<b>I-5 Downtown</b>						
	Lakeview Blvd. E	7/1/92	X			X
	Roanoke St.	4/7/93	X		X	
	S Holgate St.	6/23/92				X
	Michigan St.	6/26/92				
	Corson Ave. S	6/23/92				
	Albro Pl.	6/26/92	X	X		X
	S 144th St.	7/9/92				X
	Olive St.	9/22/92			X	
	Howell/Yale Sts.	9/29/92			X	
	Madison St.	12/18/92			X	
	Stewart St.	12/28/92			X	
<b>I-5 South</b>						
	S 178th St.	7/2/92				X
	S 188th St./ Orilla Rd.	6/23/92			X	
	S 200th St.	7/31/92			X	
	S 216th St.	6/23/92	X	X		X
	SR 516 -Kent/DesMoine Ramp	7/7/92			X	
	SR 516 -Kent Ramp	7/29/92			X	
	SR 516 -DesMoines Ramp	8/5/92			X	
	S 260th St.	7/14/92				X
	S 272nd St.	6/23/92			X	
<b>SR 520</b>						
	Hunt's Point	7/7/92			X	X
	Yarrow Point	6/24/92	X	X		
	SR 908 -Bellevue/ Kirkland	6/24/92			X	X
	124th Ave. NE.	6/24/92			X	
	148th Ave. NE.	7/27/92	X			X
	148th Ave. NE/ Redmond Ramp	7/9/92			X	
	148th Ave. NE/ Bellevue Ramp	7/13/92			X	

**Table A1 Observation Sites: Beginning Date & Characteristics  
(continued)**

Corridor	Location	Date	Mainline	HOV	Ramp	Travel Time
<b>I-90</b>						
	23rd Ave. S	6/29/92				X
	35th Ave. S	6/29/92				X
	Reversible Lanes I-90	8/10/94	X	X		
	60th Ave. SE/ W Mercer Wy.	6/29/92			X	
	Island Crest Wy.	6/24/92	X		X	
	E Mercer Wy.	7/2/92			X	X
	Bellevue Wy.	7/28/92			X	
	Newport Wy.	8/2/93	X	X	X	
	Front St.	8/16/93			X	
	142nd	9/21/93	X			
	SR 900	9/21/93			X	
<b>I-405 South</b>						
	Tukwila Pkwy.	6/25/92	X	X		X
	SR 167	6/30/92			X	
	Benson Rd.	8/3/92				X
	S Park Dr.	7/10/92			X	
	112th Ave. SE	6/22/92	X	X	X	X
<b>I-405 Central</b>						
	SE 8th St.	7/10/92			X	
	NE 4th St.	7/12/94	X	X		
	NE 8th St.	8/17/92	X	X		
	NE 12th St.	7/22/92	X	X		X
<b>I-405 North</b>						
	SR 908	7/8/92	X	X		X
	NE 160th St.	6/17/98	X			
<b>Outlying Sites</b>						
	I-5N @ 112th SE-Everett	8/9/93	X			
	I-5S @ Fife	8/26/93	X			
	I-5S @ Tacoma Mall	9/20/93	X			
	SR 16 @ Tacoma Narrows Br.	8/12/93	X			
	SR 512 @ Ainsworth	9/22/93	X			
	SR 410 @ Valley Ave.	9/21/93	X			
	SR 167 @ 37th NW -Auburn	9/27/93	X			
	SR 167 @ S 208th -Kent	8/3/93	X	X		

**APPENDIX B**

**ACO Data**

**Table B1: All Observation Sites, July 1992 - June 1998**

<b>I-5 North (corridor 1)</b>	<b>I-5 Downtown (corridor 2)</b>	<b>I-5 South (corridor 3)</b>
11 = SW 236th St	21a = Lakeview Blvd. 21b = Roanoke	31
12	22 = S Holgate St	32 = S 188th/Orilla Rd
13 = N 175th St	23 = Michigan St.	33 = S 200th St
14 = N 145th St	24 = Corson Ave. S.	34 = S 216th St
15	25 = Albro Pl	35 = SR-516 -Kent/Des Moines Rd
16 = NE Northgate Wy	26	36 = SR-516 -Kent Ramp
	27 = Olive St	37 = SR-516 -Des Moines Ramp
	28 = Howell & Yale	38
	29 = Madison St	39 = S 272nd St
	20 = Stewart St	
<b>SR 520 (corridor 4)</b>	<b>I-90 (corridor 5)</b>	<b>I-405 South (corridor 6)</b>
41 = Hunt's Point	51	61 = Tukwila Pkwy — Southcenter
42 = Yarrow Point	52 = Reversible	62 = SR-167 -Renton
43 = Sr-908 -Bellevue/Kirkland	53 = 60th Ave SE/W Mercer Wy	63
44 = 124th Ave NE	54 = Island Crest Wy	64 = S Park Dr
45 = 148th Ave NE	55 = East Mercer Wy	65 = 112th Ave SE/Lake Wash. Bvd
46 = 148th -Redmond Ramp	56 = Bellevue Wy	
47 = 148th -Bellevue Ramp	57 = Newport Wy — Issaquah	
	58 = Front St — Issaquah	
	59 = 142nd Ave	
	50 = SR-900	
<b>I-405 Central (corridor 7)</b>	<b>I-405 North (corridor 8)</b>	<b>Outlying Locations</b>
71 = SE 8th St.	81 = SR 908 -Kirkland/Redmond	91 = I-5N @ 112th SE -Everett
72 = NE 8th St	88 = NE 160th St. (Juanita - Woodinville)	92 = I-5S @ Fife
73a = NE 12th St		93 = I-5S @ Tacoma Mall
73b = NE 4th St		94 = SR-16 @ Tacoma Narrows Bridge
		95 = SR-512 @ Ainsworth
		96 = SR-410 @ Valley Ave -Sumner
		97 = SR-167 @ 137th NW -Auburn
		98 = SR-167 @ S 208th -Kent

\*Site numbers with no designation indicate discontinued sites.

**Table B2: Occupancy Code for ACO Data Tables**

1 = single occupancy vehicle
2 = double occupancy vehicle
3 = triple occupancy vehicle
4+ = four or greater occupancy vehicle
Van = Corporate or Transit Vanpools
Public Transit = Metro, Pierce, or Comm.
Other Bus = Greyhound, school buses, etc.
2 Axle = light weight commercial trucks
3+ Axle = freight and long haul trucks
Motorcycle = 2 wheel motorized vehicles

I-5 North



**Vehicle Occupancy  
(ACO) Sites  
(Corridor #1N)**

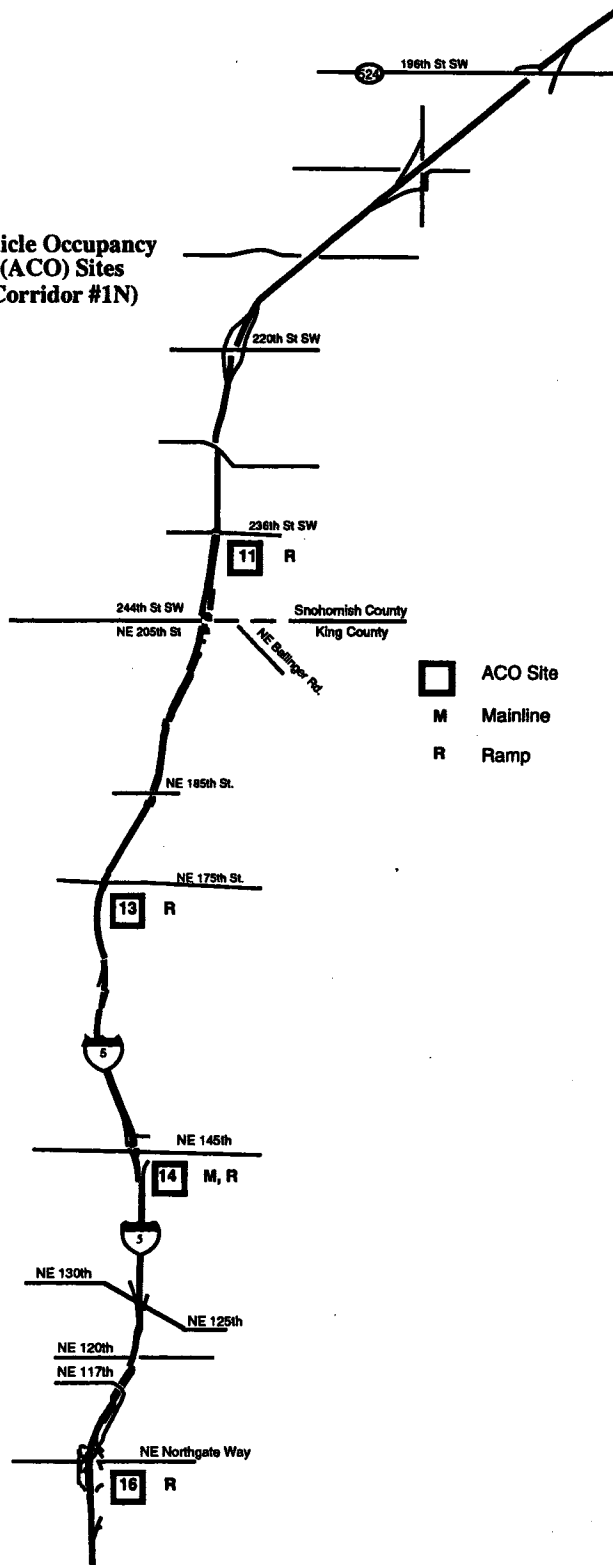



**SITE #11. I-5 NORTH - 236th Street SW**

- ACO on/ramp SB-am
- ACO off/ramp NB-pm

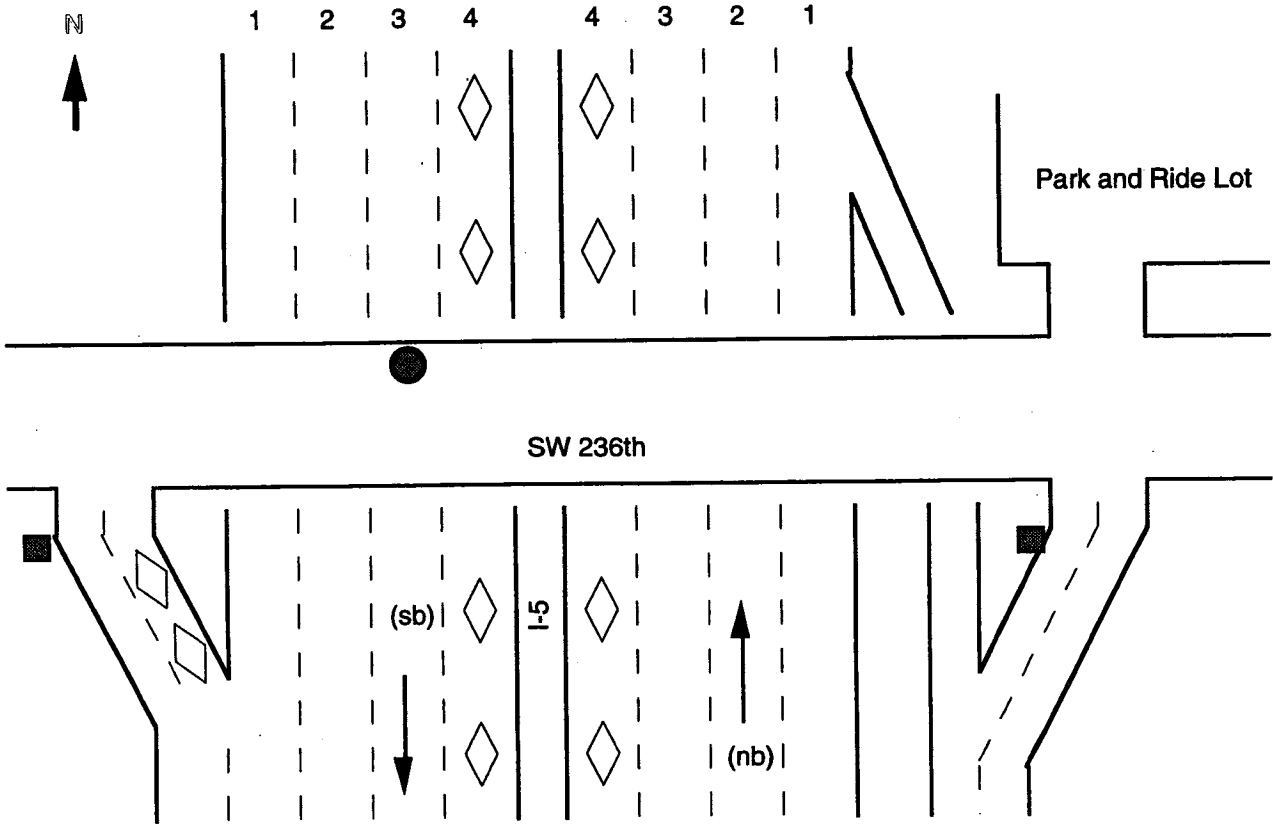

**a.m. southbound**

	Qtr.	1	2	3	4+	Van	Public Transit	Other Bus	2 Axle	3+ Axle	Motor- cycle	TOTAL OBS.	ACO Counts	
On ramp	Q3/92	2929	554	103	32	6	16	20	27	8	28	3723	1.24	
	Q4/92	3200	962	69	11	15	39	7	27	2	15	4347	1.27	
	Q1/93	1447	440	78	17	9	18	7	17	1	13	2047	1.33	
	Q2/93	2146	500	75	29	11	24	6	32	2	16	2841	1.27	
	Q3/93	No observations											--	
	Q4/93	No observations											--	
	Q1/94	1196	301	31	12	2	14	6	15	4	6	1587	1.26	
	Q2/94	1523	344	50	20	5	22	4	47	7	10	2032	1.26	
	Q3/94	1748	335	43	11	16	21	0	15	4	15	2208	1.21	
	Q4/94	516	75	4	8	0	7	3	14	3	0	630	1.18	
	Q1/95	1292	138	13	12	7	17	6	20	3	6	1514	1.14	
	Q2/95	1653	306	31	8	15	15	5	11	8	10	2061	1.20	
	Q3/95	No observations											--	

**p.m. northbound**

	Qtr.	1	2	3	4+	Van	Public Transit	Other Bus	2 Axle	3+ Axle	Motor- cycle	TOTAL OBS.	ACO	Counts
Off ramp	Q3/92	5485	1456	256	107	45	28	2	74	2	71	7526	1.32	14
	Q4/92	1867	311	39	15	20	6	2	26	1	10	2297	1.20	4
	Q1/93	7875	1603	227	49	60	37	9	126	6	32	10024	1.23	20
	Q2/93	No observations											--	
	Q3/93	2764	605	89	26	17	10	1	44	2	18	3576	1.25	7
	Q4/93	5659	1152	140	67	38	20	7	95	13	16	7207	1.23	14
	Q1/94	1778	315	39	14	10	6	3	20	2	9	2196	1.20	4
	Q2/94	1307	285	43	26	10	7	2	33	0	24	1737	1.27	5
	Q3/94	3427	790	147	58	35	18	3	45	5	33	4561	1.29	11
	Q4/94	2588	682	90	52	31	14	5	60	6	9	3537	1.30	9
	Q1/95	2969	720	73	40	34	19	7	42	3	6	3913	1.26	10
	Q2/95	1584	406	53	25	10	12	0	17	3	10	2120	1.29	5
	Q3/95	No observations											--	

**SITE #13. I-5 NORTH - North 175th Street**

- ACO on/ramp SB-am
- ACO off/ramp NB-pm

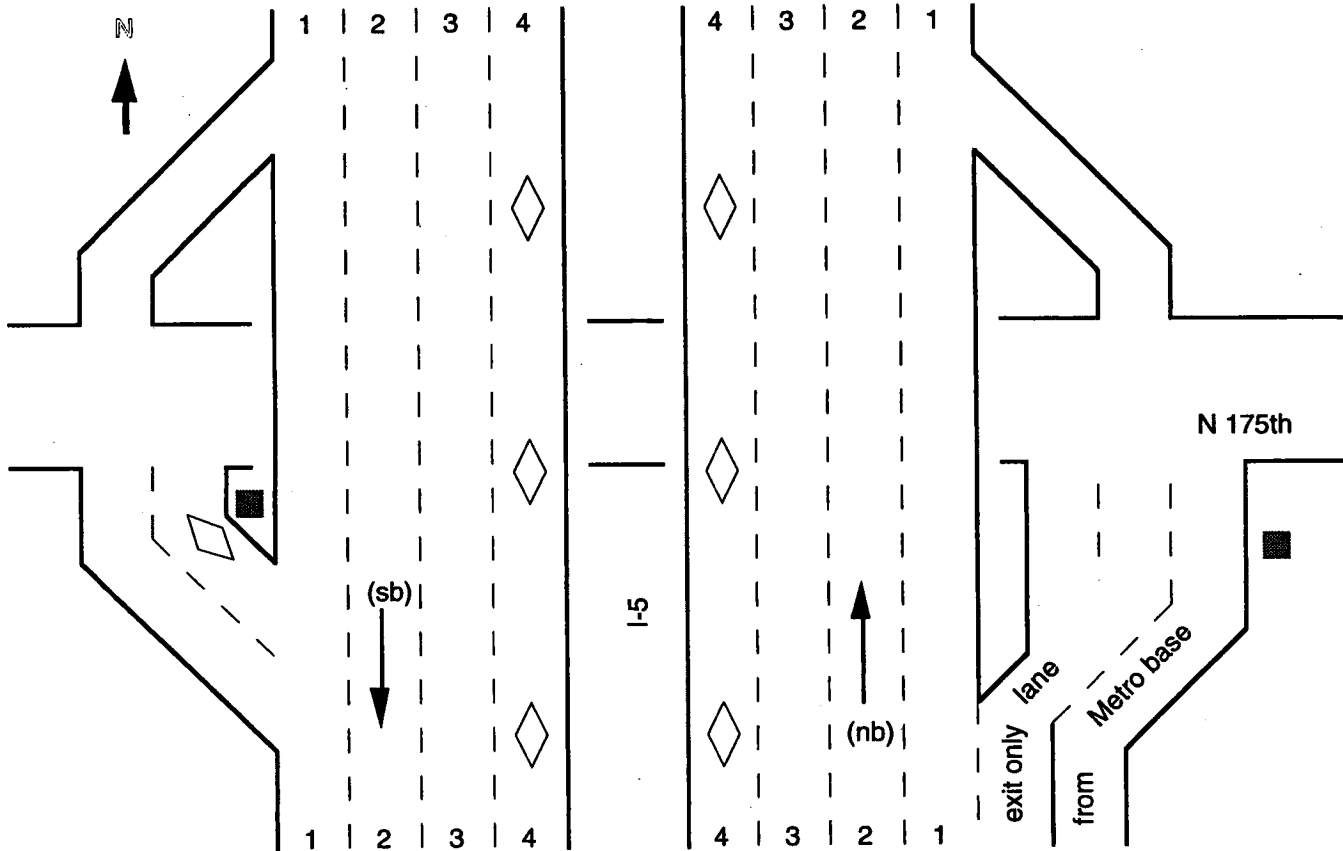



**a.m. southbound**

	Qtr.	1	2	3	4+	Van	Public Transit	Other Bus	2 Axle	3+ Axle	Motor- cycle	TOTAL OBS.	ACO Counts	
On ramp	Q3/92	8033	1572	223	49	9	81	1	120	69	59	10216	1.22	26
	Q4/92	6170	1167	72	19	6	63	2	74	48	34	7655	1.18	17
	Q1/93	1724	221	23	2	2	15	2	22	10	6	2027	1.14	4
	Q2/93	1224	292	54	15	4	15	0	21	10	4	1657	1.28	5
	Q3/93	1055	280	16	7	1	15	0	16	11	4	1405	1.25	9
	Q4/93	760	161	19	9	1	12	2	4	9	6	983	1.24	3
	Q1/94	2073	527	51	12	4	23	3	35	10	11	2749	1.25	8
	Q2/94	1954	464	46	14	2	29	3	30	11	2	2555	1.24	9
	Q3/94	2953	650	97	45	4	36	2	30	38	26	3881	1.26	11
	Q4/94	1172	249	21	8	7	20	0	33	9	2	1521	1.22	7
	Q1/95	1586	374	32	4	3	22	0	16	10	1	2048	1.23	6
	Q2/95	2115	371	35	13	6	27	2	27	14	23	2633	1.19	11
	Q3/95	No Observations											--	

<b>p.m. northbound</b>		<b>Qtr.</b>	<b>1</b>	<b>2</b>	<b>3</b>	<b>4+</b>	<b>Van</b>	<b>Public Transit</b>	<b>Other Bus</b>	<b>2 Axle</b>	<b>3+ Axle</b>	<b>Motor- cycle</b>	<b>TOTAL OBS.</b>	<b>ACO</b>	<b>Counts</b>
Off ramp	Q3/92	9367	1662	308	136	13	62	9	101	33	64	<b>11755</b>	<b>1.24</b>	<b>18</b>	
	Q4/92	5466	714	62	19	14	35	5	75	24	12	<b>6426</b>	<b>1.14</b>	<b>13</b>	
	Q1/93	14713	1865	183	63	19	89	13	126	40	36	<b>17147</b>	<b>1.14</b>	<b>30</b>	
	Q2/93	4928	758	90	41	8	33	2	73	10	23	<b>5966</b>	<b>1.18</b>	<b>9</b>	
	Q3/93	4773	677	108	55	4	30	5	47	17	23	<b>5739</b>	<b>1.19</b>	<b>9</b>	
	Q4/93	7786	1212	139	37	18	63	7	105	13	22	<b>9402</b>	<b>1.18</b>	<b>17</b>	
	Q1/94	5040	567	32	25	7	41	4	70	12	15	<b>5803</b>	<b>1.13</b>	<b>10</b>	
	Q2/94	2712	504	64	37	4	18	2	26	9	6	<b>3382</b>	<b>1.23</b>	<b>6</b>	
	Q3/94	8157	1197	138	55	17	59	3	71	13	74	<b>9784</b>	<b>1.17</b>	<b>16</b>	
	Q4/94	1916	320	36	18	4	16	2	29	3	2	<b>2346</b>	<b>1.20</b>	<b>5</b>	
	Q1/95	7865	1256	121	38	29	54	12	60	5	24	<b>9464</b>	<b>1.17</b>	<b>15</b>	
	Q2/95	2665	460	43	30	6	18	3	45	4	17	<b>3291</b>	<b>1.20</b>	<b>5</b>	
	Q3/95	No observations											--		

**SITE #14. I-5 NORTH - Northeast 145th Street**

-  ACO mainline SB-am & NB-pm
-  ACO on/ramp SB-am
-  ACO off/ramp NB-pm

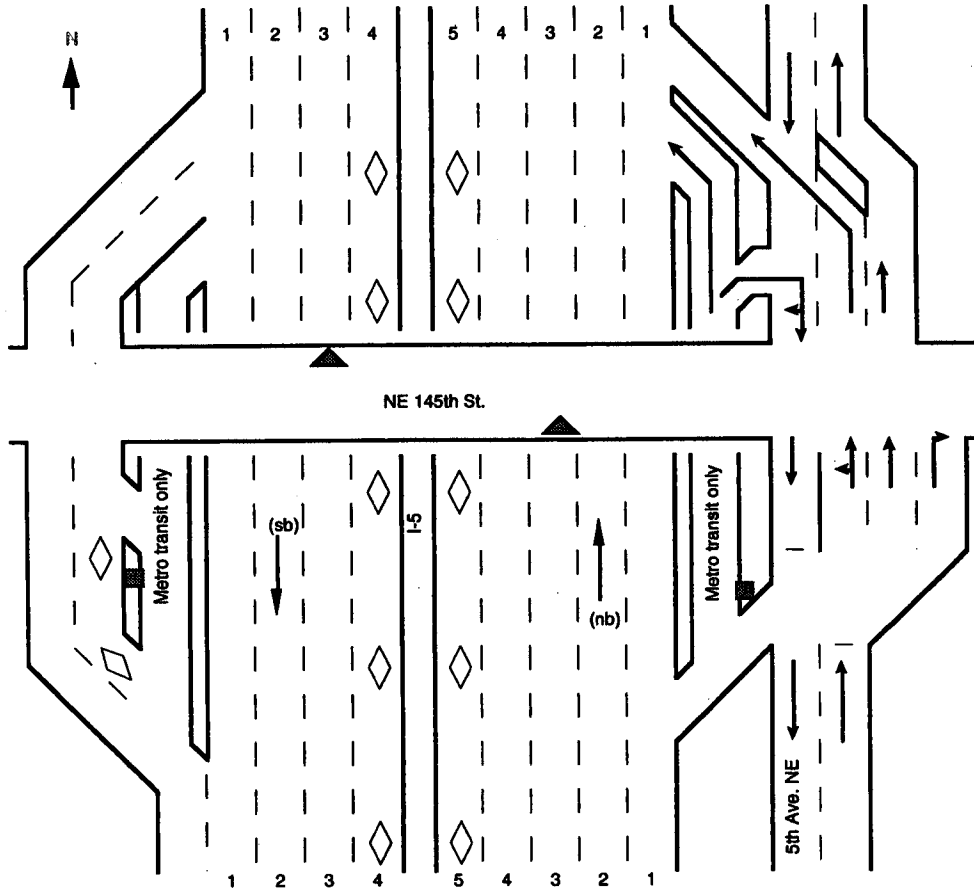

**I-5 North - NE 145th Street a.m. southbound**

	Qtr.	1	2	3	4+	Van	Public Transit	Other Bus	2 Axle	3+ Axle	Motor- cycle	TOTAL OBS.	ACO	Counts
HOV lanes 1	Q3/92	12	654	105	33	4	18	18	2	0	28	874	2.21	2
	Q4/92	72	842	94	7	9	43	2	15	0	27	1111	2.04	3
	Q1/93	14	1180	71	11	10	55	6	3	0	28	1378	2.06	2
	Q2/93	44	1865	173	54	6	97	3	18	1	53	2314	2.12	4
	Q3/93	35	2097	304	97	32	109	15	23	5	108	2825	2.19	6
	Q4/93	59	948	69	24	0	32	11	5	0	19	1167	2.06	4
	Q1/94	9	485	49	17	0	22	6	6	4	3	601	2.14	2
	Q2/94	23	1034	103	36	8	42	8	11	0	16	1281	2.13	3
	Q3/94	22	910	82	34	4	44	1	16	2	35	1150	2.13	3
	Q4/94	74	2020	99	23	22	110	2	15	1	19	2385	2.03	5
	Q1/95	29	1995	109	19	7	119	13	23	0	13	2327	2.06	6
	Q2/95	94	3173	197	34	57	175	12	24	1	113	3880	2.05	11
	Q3/95	26	878	32	18	16	62	6	13	0	30	1081	2.05	8
	No observations conducted Q4/95 - Q2/96												--	
	Q3/96	21	3046	178	72	78	175	17	23	0	132	3742	2.10	9
	No observations conducted Q4/96 - Q1/97												--	
	Q2/97	19	3273	256	59	71	179	9	27	3	87	3983	2.10	11
	Q3/97	180	4507	369	122	98	272	5	27	0	156	5736	2.09	11
	No observation conducted Q4/97 - Q1/98													
	Q2/98	170	6491	600	136	148	351	27	94	1	156	8174	2.10	15
	<b>99</b>													
GP lanes 3	Q3/92	5354	379	36	8	0	16	4	67	105	12	5981	1.08	7
	Q4/92	4042	255	31	5	2	6	0	61	58	2	4462	1.08	5
	Q1/93	6229	356	12	1	1	4	1	89	130	6	6829	1.06	7
	Q2/93	11174	680	41	14	6	15	8	228	234	20	12420	1.07	15
	Q3/93	12211	917	94	23	5	14	4	220	294	24	13806	1.09	16
	Q4/93	10526	657	90	27	3	16	2	162	200	17	11700	1.08	14
	Q1/94	7428	275	13	6	3	8	5	98	157	3	7996	1.04	12
	Q2/94	7844	403	43	18	4	11	4	112	190	10	8639	1.07	11
	Q3/94	7249	457	22	9	3	19	2	191	226	16	8194	1.07	11
	Q4/94	2473	122	2	2	1	3	0	32	68	0	2703	1.05	5
	Q1/95	1733	101	5	7	1	2	1	25	58	1	1934	1.07	3
	Q2/95	5113	167	6	32	5	13	1	77	192	5	5611	1.05	9
	Q3/95	1902	76	2	0	0	10	1	42	113	3	2149	1.04	8
	No observations conducted Q4/95 - Q2/96												--	
	Q3/96	3814	183	10	5	6	11	1	72	128	8	4238	1.05	7
	No observations conducted Q4/96 - Q1/97												--	
	Q2/97	4606	343	24	8	5	12	1	87	133	8	5227	1.08	9
	Q3/97	6657	205	11	8	10	17	0	110	206	9	7233	1.04	11
	No observations conducted Q4/97 - Q1/98													
	Q2/98	13105	894	73	29	20	26	8	399	384	12	14950	1.08	18
	<b>168</b>													

**I-5 North - NE 145th Street mid-day southbound (week-end)**

	Qtr.	1	2	3	4+	Van	Public Transit	Other Bus	2 Axle	3+ Axle	Motor- cycle	TOTAL OBS.	ACO	Counts
HOV lanes 1	Q2/97	11	2227	271	170	22	4	21	2	0	21	2749	2.24	9

**I-5 North - NE 145th Street mid-day southbound (week-end)**

	Qtr.	1	2	3	4+	Van	Public Transit	Other Bus	2 Axle	3+ Axle	Motor- cycle	TOTAL OBS.	ACO	Counts
GP lanes 3	Q2/97	2604	1294	145	70	27	2	6	56	48	6	4258	1.44	8

**I-5 North - NE 145th Street p.m. northbound**

	Qtr.	1	2	3	4+	Van	Public Transit	Other Bus	2 Axle	3+ Axle	Motor- cycle	TOTAL OBS.	ACO	Counts
HOV lanes 1	Q3/92	18	652	121	32	10	33	3	1	1	37	908	2.21	2
	Q4/92	7	841	37	6	6	34	5	5	2	13	956	2.05	2
	Q1/93	2	624	61	17	3	30	0	3	0	10	750	2.14	1
	Q2/93	25	1109	141	51	17	37	4	18	0	45	1447	2.17	2
	Q3/93	17	686	122	56	8	44	4	9	0	20	966	2.26	2
	Q4/93	No observations											--	
	Q1/94	40	1450	208	55	34	68	3	11	0	23	1892	2.16	3
	Q2/94	84	1268	73	30	14	46	9	15	0	17	1556	2.04	2
	Q3/94	46	2237	237	91	42	80	19	18	0	112	2882	2.15	5
	Q4/94	35	2821	202	71	77	111	10	27	0	54	3408	2.10	7
	Q1/95	40	3467	198	68	64	137	10	20	0	41	4045	2.08	8
	Q2/95	70	3399	259	79	88	137	9	30	0	97	4168	2.10	11
	Q3/95	32	3546	158	41	75	136	17	19	0	100	4124	2.06	8
	No observations conducted Q4/95 - Q2/96												--	
	Q3/96	21	2208	216	88	58	100	16	20	3	92	2822	2.15	9
	No observations conducted Q4/96 - Q1/97												--	
	Q2/97	56	5735	458	94	76	203	19	26	0	179	6846	2.10	12
	Q3/97	64	3683	502	196	61	157	12	1	0	144	4820	2.20	11
	No observations conducted Q4/97 - Q1/98												--	
	Q2/98	81	7247	678	195	198	297	49	130	2	167	9044	2.13	19

104

**I-5 North - NE 145th Street p.m. northbound**

	Qtr.	1	2	3	4+	Van	Public Transit	Other Bus	2 Axle	3+ Axle	Motor- cycle	TOTAL OBS.	ACO	Counts
GP lanes 4	Q3/92	4187	649	80	40	1	7	2	83	76	12	5137	1.19	11
	Q4/92	4036	396	33	15	1	6	2	78	61	5	4633	1.11	7
	Q1/93	4968	648	32	3	3	11	2	70	96	5	5838	1.13	10
	Q2/93	8752	939	51	17	7	11	3	1165	152	8	11105	1.11	16
	Q3/93	14864	2089	345	149	13	32	18	329	230	43	18112	1.19	26
	Q4/93	3011	253	21	5	2	3	2	6	41	3	3347	1.09	4
	Q1/94	7157	669	83	21	6	4	3	99	122	1	8165	1.11	13
	Q2/94	7244	766	81	40	6	7	3	179	143	9	8478	1.13	12
	Q3/94	5171	709	52	29	4	10	11	145	89	18	6238	1.15	13
	Q4/94	3028	950	84	22	15	27	5	54	44	5	4234	1.29	8
	Q1/95	5152	369	31	11	4	7	0	68	110	0	5752	1.08	9
	Q2/95	6516	612	59	24	8	10	0	84	133	15	7461	1.11	12
	Q3/95	3903	400	50	25	15	4	2	51	93	15	4558	1.13	9
	No observations conducted Q4/95 - Q2/96												--	
	Q3/96	2374	264	26	19	5	6	4	45	65	10	2818	1.14	8
	No observations conducted Q4/96 - Q1/97												--	
	Q2/97	6607	866	60	16	12	7	0	74	101	15	7758	1.14	10
	Q3/97	3332	412	31	24	10	13	0	36	38	11	3907	1.14	7
	No observations conducted Q4/97 - Q1/98												--	
Q2/98	13069	1434	161	66	12	27	7	331	261	17	15385	1.13	24	
<b>199</b>														

**I-5 North - NE 145th Street mid-day northbound (week-end)**

	Qtr.	1	2	3	4+	Van	Public Transit	Other Bus	2 Axle	3+ Axle	Motor- cycle	TOTAL OBS.	ACO	Counts
HOV lanes 1	Q2/97	9	1486	109	28	16	4	18	2	0	23	1695	2.10	6
<b>6</b>														

**I-5 North - NE 145th Street mid-day northbound (week-end)**

	Qtr.	1	2	3	4+	Van	Public Transit	Other Bus	2 Axle	3+ Axle	Motor- cycle	TOTAL OBS.	ACO	Counts
GP lanes 3	Q2/97	1663	729	46	16	2	1	0	20	20	2	2499	1.36	6
<b>6</b>														



**I-5 North - NE 145th Street**

**a.m. southbound**

	Qtr.	1	2	3	4+	Van	Public Transit	Other Bus	2 Axle	3+ Axle	Motor- cycle	TOTAL OBS.	ACO	Counts
On ramp	Q3/92	10190	1307	185	66	17	52	13	120	43	56	12049	1.16	17
	Q4/92	7178	885	98	36	6	57	10	59	39	12	8379	1.15	14
	Q1/93	5050	571	56	26	9	30	12	54	14	6	6328	1.12	8
	Q2/93	8761	1049	73	22	3	45	5	123	37	29	10147	1.13	12
	Q3/93	5894	511	58	19	2	32	7	54	23	40	6650	1.11	13
	Q4/93	5656	473	35	26	2	36	17	55	27	16	6343	1.10	10
	Q1/94	4315	303	25	18	0	22	14	42	11	5	4755	1.09	8
	Q2/94	6757	760	108	31	9	34	22	69	22	12	7824	1.14	10
	Q3/94	3687	345	27	13	2	20	8	41	16	22	4181	1.11	7
	Q4/94	4406	432	46	17	6	23	9	42	13	10	5004	1.12	7
	Q1/95	4686	548	39	5	3	20	10	36	24	8	5379	1.12	7
	Q2/95	5385	660	31	6	5	34	8	44	26	27	6226	1.12	9
	Q3/95	No observations											--	
														122

**p.m. northbound**

	Qtr.	1	2	3	4+	Van	Public Transit	Other Bus	2 Axle	3+ Axle	Motor- cycle	TOTAL OBS.	ACO	Counts
Off ramp	Q3/92	4779	896	170	79	14	2	2	56	14	43	6055	1.25	12
	Q4/92	6332	1048	108	27	11	17	7	73	18	16	7657	1.18	14
	Q1/93	9256	1586	193	70	11	34	13	1948	19	23	13153	1.20	23
	Q2/93	2059	465	47	16	0	18	1	17	4	8	2635	1.24	5
	Q3/93	5039	977	178	79	9	39	1	72	38	19	6451	1.25	13
	Q4/93	1781	336	55	13	9	0	5	18	8	1	2226	1.22	4
	Q1/94	1823	346	33	16	3	3	3	13	2	5	2247	1.21	4
	Q2/94	4872	940	151	74	10	36	4	53	10	21	6171	1.24	11
	Q3/94	6931	1240	180	96	24	21	14	87	14	51	8658	1.23	16
	Q4/94	5797	832	87	34	15	21	5	60	8	18	6877	1.17	14
	Q1/95	1633	283	36	5	7	1	2	10	2	3	1982	1.19	5
	Q2/95	3214	626	91	31	7	22	7	69	12	14	4094	1.23	11
	Q3/95	No observations											--	
														132

**SITE #16. I-5 NORTH - NE Northgate Way**

- ACO on/ramp SB-am
- ACO off/ramp NB-pm

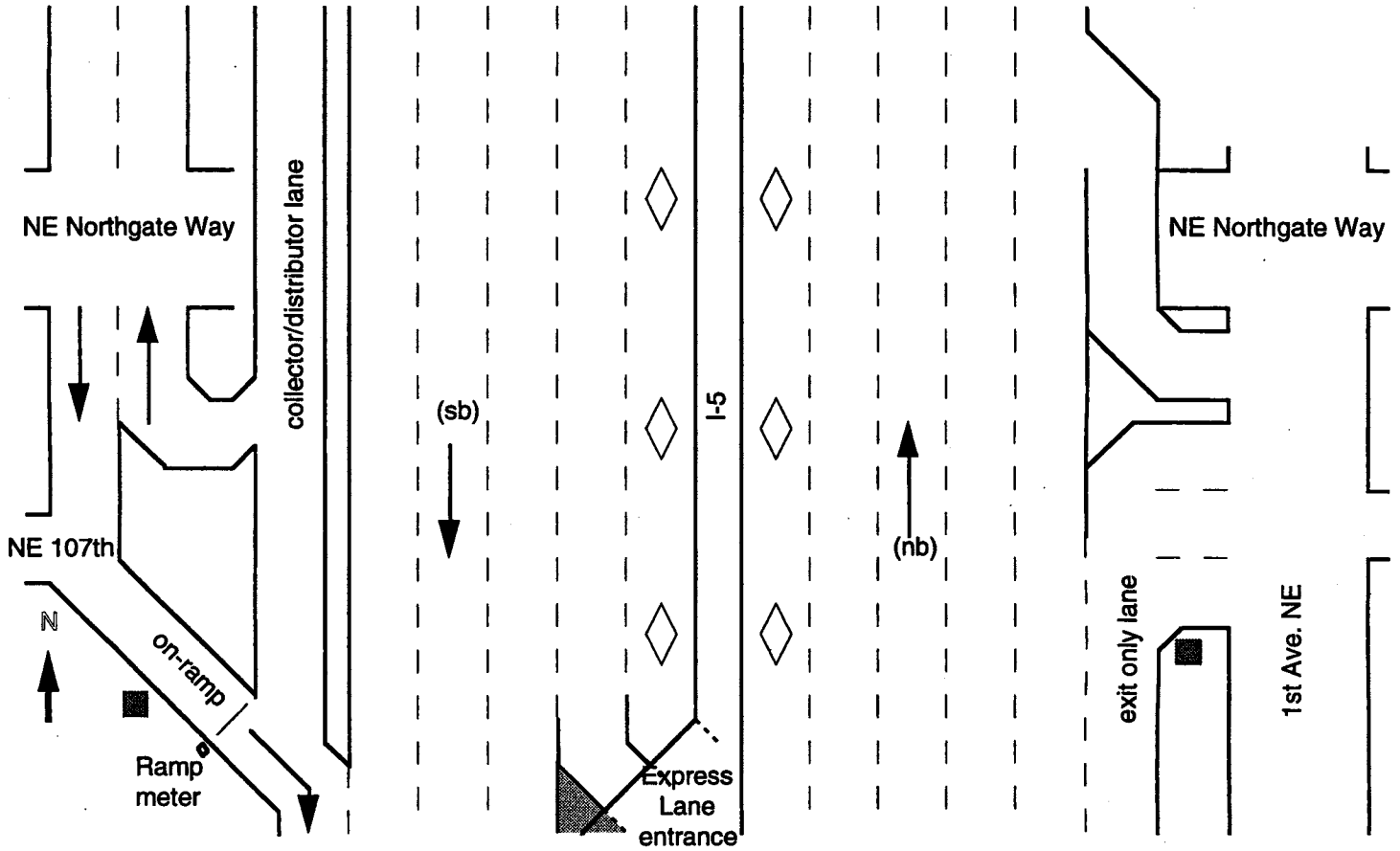

**Note:** Counting the southbound on/ramp traffic means you have to count all the cars on the collector/distributor lane. To do this, walk down the ramp until the c/d lane merges into one, and sit behind the jersey barrier for safety.

**I-5 North - NE Northgate Way**

**a.m. southbound**

	Qtr.	1	2	3	4+	Van	Public Transit	Other Bus	2 Axle	3+ Axle	Motor- cycle	TOTAL OBS.	ACO	Counts
On ramp	Q3/92	2807	393	47	17	7	3	8	62	15	19	3378	1.17	13
	Q4/92	2386	362	44	18	1	3	9	46	4	6	2879	1.18	13
	Q1/93	2040	294	25	5	5	5	9	41	7	9	2440	1.15	8
	Q2/93	1339	182	25	10	0	1	6	408	10	5	1986	1.17	11
	Q3/93	1644	192	24	12	2	0	22	30	8	20	1954	1.15	11
	Q4/93	843	104	16	4	2	0	5	18	3	0	995	1.15	3
	Q1/94	1734	199	23	3	0	1	13	45	2	0	2020	1.13	8
	Q2/94	2172	347	41	24	10	1	6	40	7	6	2654	1.20	9
	Q3/94	1902	281	27	4	6	0	6	47	14	7	2294	1.16	15
	Q4/94	1168	182	18	4	3	0	10	23	10	2	1420	1.17	7
	Q1/95	3082	424	44	5	7	3	15	40	13	4	3637	1.15	11
	Q2/95	2214	305	35	18	4	2	7	62	18	13	2678	1.17	10
	Q3/95	No observations											--	

119

**p.m. northbound**

	Qtr.	1	2	3	4+	Van	Public Transit	Other Bus	2 Axle	3+ Axle	Motor- cycle	TOTAL OBS.	ACO	Counts
Off ramp	Q3/92	3998	1161	240	112	5	9	4	36	19	32	5616	1.36	14
	Q4/92	5038	1124	179	58	1	22	5	117	17	9	6570	1.26	14
	Q1/93	4475	931	88	43	6	17	2	42	10	9	5623	1.22	14
	Q2/93	3329	775	71	24	1	9	6	24	20	16	4244	1.24	10
	Q3/93	3567	810	133	58	2	3	2	37	11	17	4640	1.28	10
	Q4/93	5773	1395	182	77	10	4	5	53	14	12	7525	1.27	17
	Q1/94	1857	326	37	18	0	2	4	12	6	2	2264	1.20	5
	Q2/94	4118	1034	149	57	9	3	3	44	12	26	5455	1.28	13
	Q3/94	3621	820	124	59	10	3	6	40	7	16	4706	1.27	12
	Q4/94	3318	714	90	35	3	2	6	27	8	7	4210	1.24	10
	Q1/95	1700	416	45	24	0	2	4	14	3	2	2210	1.27	5
	Q2/95	3699	900	126	35	4	5	7	29	6	30	4841	1.27	12
	Q3/95	No observations											--	

136

# Vehicle Occupancy (ACO) Sites I-5 Downtown (Corridor #2N)

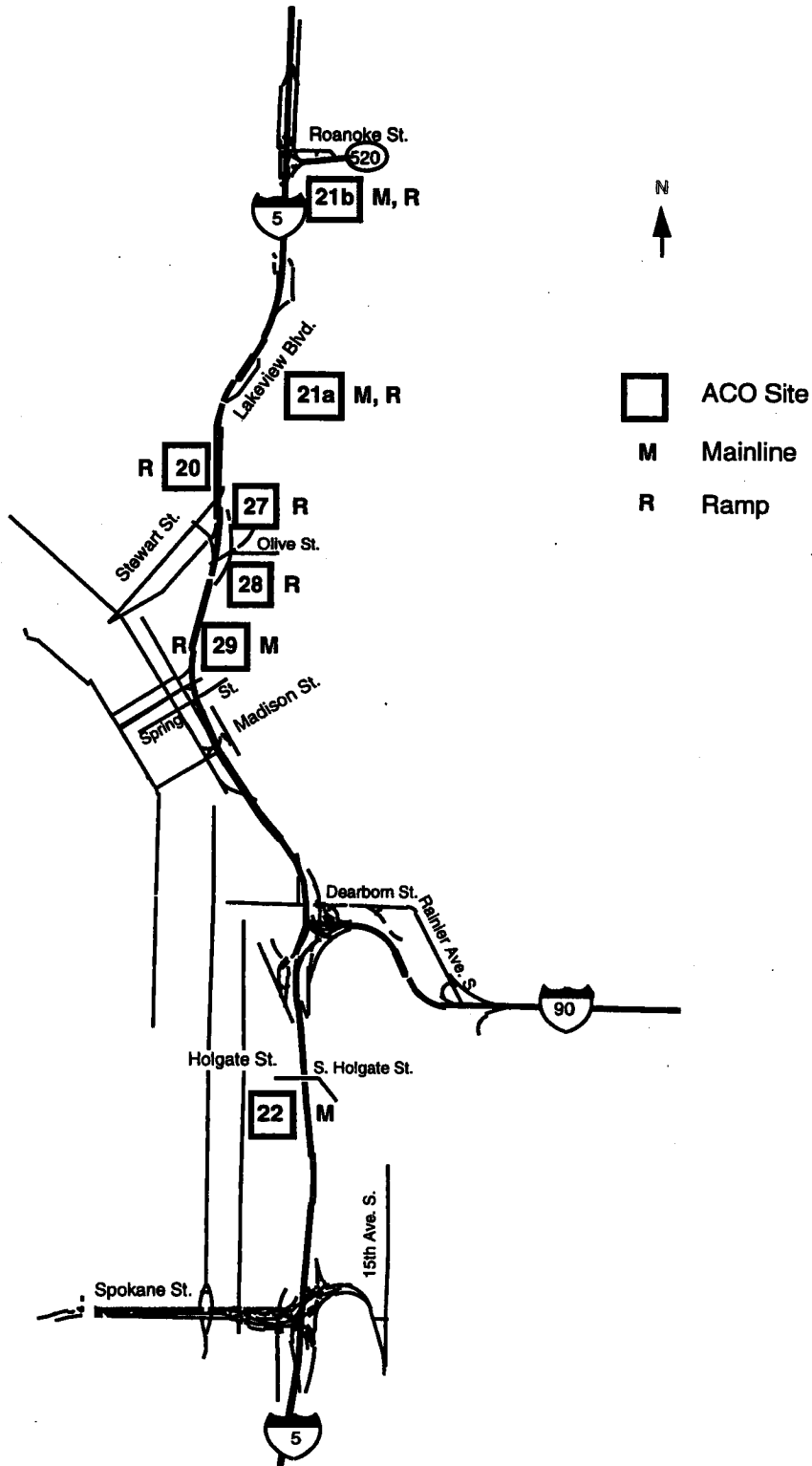

Vehicle Occupancy (ACO) Sites (cont.)  
I-5 Downtown (Corridor #2S)

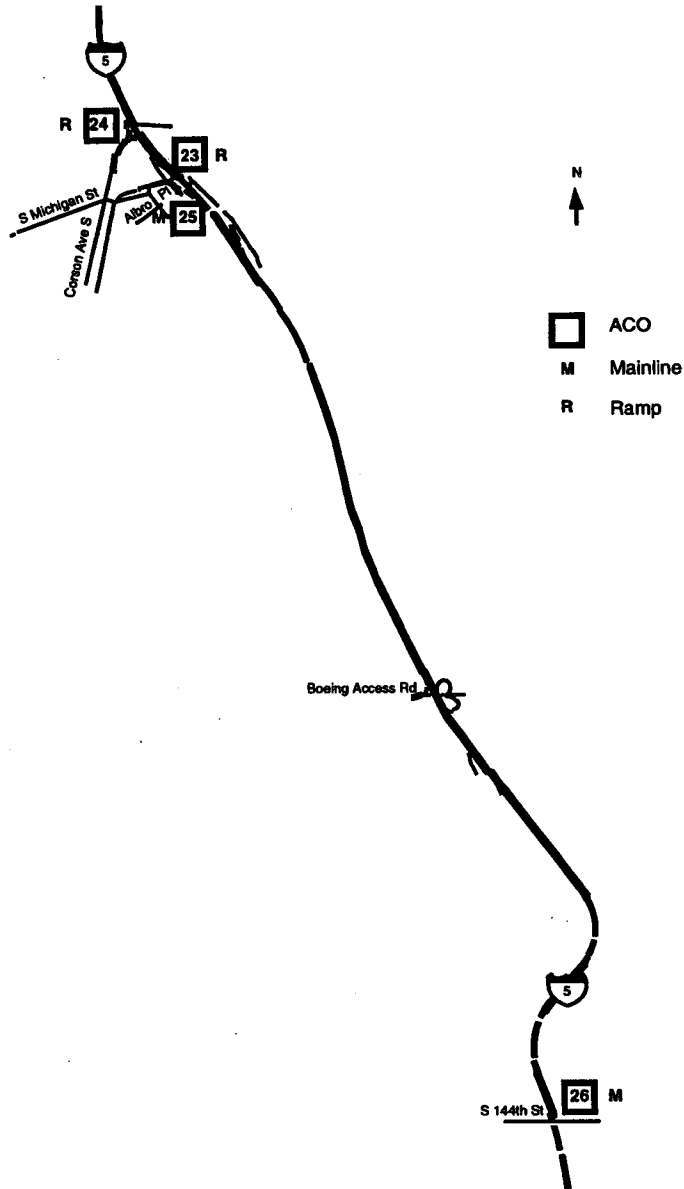

**SITE #21a. I-5 DOWNTOWN - Lakeview Boulevard**

ACO mainline SB pm  
ACO mainline NB am  
ACO off/ramp SB-am  
ACO off/ramp NB-pm

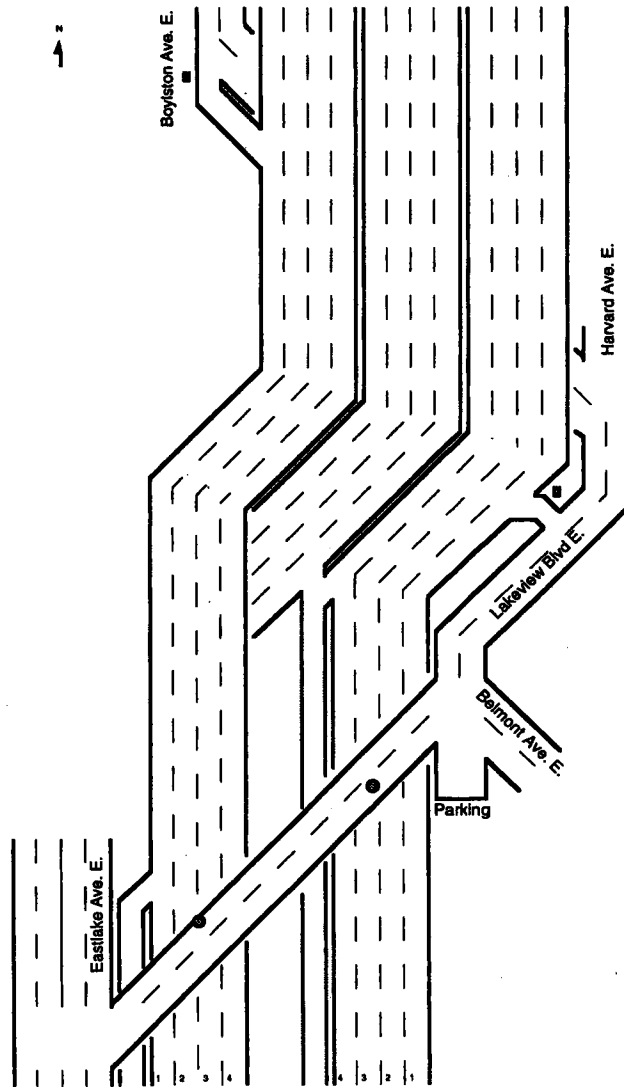

**Note: This site was suspended at end of Q2/93.**

**Downtown I-5 - Lakeview Blvd.**

**p.m. southbound**

	Qtr.	1	2	3	4+	Van	Public Transit	Other Bus	2 Axle	3+ Axle	Motor- cycle	TOTAL OBS.	ACO	Counts	
GP lanes	Q3/92	576	209	11	4	0	0	0	10	41	8	859	1.30	1	
	Q4/92	No observations											--		
4	Q1/93	No observations											--		
	Q2/93	No observations											--		
															1

**a.m. northbound**

	Qtr.	1	2	3	4+	Van	Public Transit	Other Bus	2 Axle	3+ Axle	Motor- cycle	TOTAL OBS.	ACO	Counts	
GP lanes	Q3/92	1004	202	19	3	2	20	2	46	53	4	1355	1.20	4	
	Q4/92	No observations											--		
4	Q1/93	No observations											--		
	Q2/93	No observations											--		
															4

**a.m. southbound**

	Qtr.	1	2	3	4+	Van	Public Transit	Other Bus	2 Axle	3+ Axle	Motor- cycle	TOTAL OBS.	ACO	Counts	
GP lanes	Q3/92	3428	609	49	19	4	33	13	43	41	30	4269	1.19	6	
	Q4/92	2427	228	1	0	4	8	3	11	35	1	2718	1.09	4	
4	Q1/93	No observations											--		
	Q2/93	No observations											--		
															10

**a.m. southbound**

	Qtr.	1	2	3	4+	Van	Public Transit	Other Bus	2 Axle	3+ Axle	Motor- cycle	TOTAL OBS.	ACO	Counts	
Off ramp	Q3/92	6922	614	46	9	1	0	5	106	48	30	7781	1.10	17	
	Q4/92	1708	377	43	8	1	0	1	28	12	5	2183	1.23	3	
	Q1/93	No observations											--		
	Q2/93	No observations											--		
															20

**p.m. northbound**

	Qtr.	1	2	3	4+	Van	Public Transit	Other Bus	2 Axle	3+ Axle	Motor- cycle	TOTAL OBS.	ACO	Counts	
On ramp	Q3/92	7244	1440	188	29	2	0	5	54	20	29	9011	1.21	14	
	Q4/92	3510	403	23	7	0	0	0	56	8	13	4020	1.12	7	
	Q1/93	No observations											--		
	Q2/93	No observations											--		
															21

**SITE #21b. I-5 DOWNTOWN - Roanoke Boulevard**

- ▲ ACO mainline SB & NB-am & pm
- ACO off/ramp SB-am & pm
- ACO on/ramp NB-am & pm

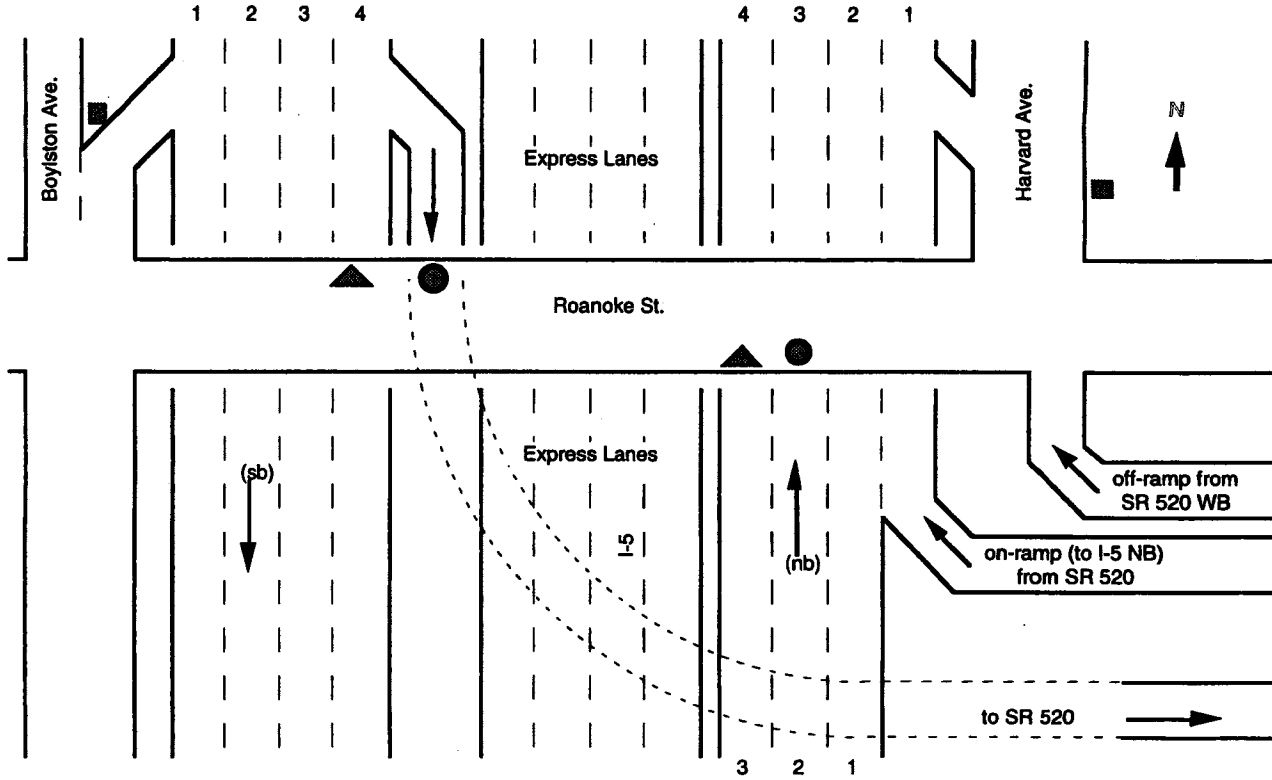

**Directions:** Take I-5 south from 45th Avenue NE, and take the first exit south of the ship canal. To count either mainline or southbound off/ramp traffic, find a place to park along the side of the street (you may need to turn right on Roanoke and go around the block).

To count northbound on/ramp traffic, turn left on Roanoke, cross over the mainline, and turn left again on Harvard Ave. The on/ramp is about a block down on your left. You can park across the street in the residential area, and sit on the sidewalk just to the south of the ramp.

**Note:** Do not count the express lanes at all in this location. The off/ramp southbound merges with traffic on Boylston Avenue East. You have to sit someplace where you can see clearly only the ramp traffic.



**I-5 Downtown - Roanoke Blvd.**

a.m. southbound		Qtr.	1	2	3	4+	Van	Public Transit	Other Bus	2 Axle	3+ Axle	Motor- cycle	TOTAL OBS.	ACO	Counts	
GP lanes 4	Q3/92	No observations											--			
	Q4/92	No observations											--			
	Q1/93	9057	864	58	9	7	23	14	177	201	10	10420	1.10	17		
	Q2/93	1987	195	17	2	0	5	3	41	32	6	2288	1.11	4		
	Q3/93	8806	799	105	52	12	23	12	169	231	37	10246	1.12	19		
	Q4/93	8921	801	68	15	5	21	18	146	153	16	10164	1.10	19		
	Q1/94	7866	881	96	23	5	74	46	185	196	8	9380	1.13	16		
	Q2/94	8282	693	71	36	6	27	31	148	220	22	9536	1.10	22		
	Q3/94	6323	675	70	28	8	17	5	99	121	29	7375	1.13	15		
	Q4/94	6108	535	39	7	2	15	21	102	159	6	6994	1.09	13		
	Q1/95	3944	338	23	9	3	16	12	84	114	6	4549	1.10	10		
	Q2/95	5576	394	36	25	13	13	10	104	116	21	6308	1.09	13		
	No observations conducted Q3/95 - Q2/96													--		
	Q3/96	6290	408	65	10	5	10	17	102	149	12	7068	1.08	14		
	No observations conducted Q4/96 - Q1/98													--		
	162															
	Off ramp	Q3/92	6812	599	44	9	1	0	5	106	48	30	7654	1.10	15	
Q4/92		1689	123	21	4	0	0	1	28	9	4	1879	1.10	4		
Q1/93		No observations											--			
Q2/93		No observations											--			
Q3/93		919	154	19	7	0	0	0	19	4	5	1127	1.20	4		
Q4/93		1647	280	47	26	0	2	13	13	1	5	2034	1.23	6		
Q1/94		3172	435	68	26	12	2	24	25	0	3	3767	1.18	12		
Q2/94		1325	226	47	25	1	1	17	8	1	3	1654	1.25	5		
Q3/94		2248	262	26	15	4	3	11	31	8	12	2620	1.14	12		
Q4/94		1681	248	32	15	2	3	14	26	2	5	2028	1.18	9		
Q1/95		1111	142	12	7	2	2	19	19	3	4	1321	1.15	7		
Q2/95	1121	165	28	41	10	3	11	11	2	4	1396	1.26	6			
Q3/95	No observations											--				
No observations conducted Q4/96 - Q1/98													--			
80																

**I-5 Downtown - Roanoke Blvd.**

**p.m. southbound**

	Qtr.	1	2	3	4+	Van	Public Transit	Other Bus	2 Axle	3+ Axle	Motor- cycle	TOTAL OBS.	ACO	Counts
GP lanes 4	Q3/92	No observations											--	
	Q4/92	No observations											--	
	Q1/93	No observations											--	
	Q2/93	2562	871	61	3	4	47	21	1530	74	19	5192	1.29	9
	Q3/93	9304	3838	610	216	14	119	42	385	302	75	14905	1.41	25
	Q4/93	8776	2693	344	117	35	118	36	255	278	56	12708	1.31	20
	Q1/94	5851	1579	246	93	7	76	33	198	192	18	8293	1.30	14
	Q2/94	9267	3006	484	286	41	142	40	365	316	48	13995	1.37	22
	Q3/94	8000	2756	365	230	24	115	33	373	276	71	12243	1.37	20
	Q4/94	4751	1194	69	19	15	60	17	205	145	22	6497	1.23	12
	Q1/95	9306	1608	188	97	15	18	14	194	214	44	11698	1.20	13
	Q2/95	6274	1859	276	58	26	94	22	261	247	44	9160	1.31	14
	No observations conducted Q3/95 - Q2/96												--	
	Q3/96	6864	1842	268	116	54	112	37	159	252	25	9729	1.30	17
	No observations conducted Q4/96 - Q1/98												--	

166

Off ramp	Q3/93	1210	342	62	19	1	15	0	23	1	12	1685	1.32	5
	Q4/93	1139	266	43	16	5	20	5	5	0	9	1508	1.28	7
	Q1/94	1004	229	22	10	0	18	5	4	0	2	1294	1.24	5
	Q2/94	2737	664	107	32	5	32	7	23	2	23	3632	1.28	12
	Q3/94	3448	773	78	48	8	41	1	27	0	54	4478	1.25	16
	Q4/94	1030	145	14	6	2	13	1	12	0	4	1227	1.16	5
	Q1/95	2400	564	75	29	5	47	10	21	0	5	3156	1.26	11
	Q2/95	1081	235	38	14	1	13	4	24	0	3	1413	1.26	5
Q3/95	No observations											--		

66

**a.m. northbound**

	Qtr.	1	2	3	4+	Van	Public Transit	Other Bus	2 Axle	3+ Axle	Motor- cycle	TOTAL OBS.	ACO	Counts
GP lanes 4	Q3/92	No observations											--	
	Q4/92	No observations											--	
	Q1/93	664	61	7	2	0	4	0	19	19	4	780	1.11	2
	Q2/93	1814	344	12	6	0	34	15	113	169	11	2518	1.18	5
	Q3/93	8464	1197	128	95	17	156	53	399	394	52	10955	1.18	24
	Q4/93	8400	1073	109	66	12	253	109	399	439	33	10893	1.16	14
	Q1/94	8411	1039	110	42	10	132	94	414	203	17	10472	1.15	18
	Q2/94	12443	1796	221	79	37	329	101	566	548	69	16189	1.17	25
	Q3/94	5632	1042	129	55	25	119	26	346	258	41	7673	1.22	12
	Q4/94	6911	1037	66	16	23	164	62	334	326	22	8961	1.15	15
	Q1/95	4855	761	48	10	15	95	28	200	224	11	6247	1.16	9
	Q2/95	5497	693	73	20	9	174	53	236	228	15	6998	1.14	14
	No observations conducted Q3/95 - Q2/96												--	
	Q3/96	9458	752	60	27	27	264	105	366	410	26	11495	1.09	25
	No observations conducted Q4/96 - Q1/98												--	

163

**I-5 Downtown - Roanoke Blvd.**

**a.m. northbound**

	Qtr.	1	2	3	4+	Van	Public Transit	Other Bus	2 Axle	3+ Axle	Motor- cycle	TOTAL OBS.	ACO	Counts
On ramp	Q3/93	696	86	9	5	1	0	1	5	3	3	809	1.15	5
	Q4/93	606	97	6	7	0	0	9	6	1	0	732	1.18	4
	Q1/94	732	110	11	4	4	1	7	2	1	0	872	1.17	4
	Q2/94	1083	132	23	10	0	1	13	9	4	4	1279	1.17	10
	Q3/94	1113	190	28	11	0	1	12	11	2	12	1380	1.21	12
	Q4/94	1080	182	18	6	3	2	10	12	2	3	1318	1.18	9
	Q1/95	1237	204	28	10	5	2	15	6	0	2	1509	1.20	8
	Q2/95	785	130	15	3	4	0	14	7	1	2	961	1.18	6
	Q3/95	No observations											--	

58

**p.m. northbound**

	Qtr.	1	2	3	4+	Van	Public Transit	Other Bus	2 Axle	3+ Axle	Motor- cycle	TOTAL OBS.	ACO	Counts
GP lanes 4	Q3/92	No observations											--	
	Q4/92	No observations											--	
	Q1/93	7645	1951	104	20	5	19	13	2061	152	39	12009	1.23	16
	Q2/93	8018	1749	126	18	7	19	17	152	152	33	10291	1.21	14
	Q3/93	19593	4561	625	281	23	30	36	433	358	93	26033	1.27	35
	Q4/93	8945	1807	269	89	9	16	18	139	151	33	11476	1.24	17
	Q1/94	11823	2283	296	95	38	24	35	186	166	31	14977	1.22	18
	Q2/94	10724	1970	247	92	53	13	19	189	186	50	13543	1.21	17
	Q3/94	13866	2962	458	218	40	38	20	243	246	72	18163	1.26	22
	Q4/94	11473	1757	216	92	19	16	22	214	212	34	14055	1.18	18
	Q1/95	9306	1608	188	97	15	18	14	194	214	44	11698	1.20	15
	Q2/95	8976	2082	164	39	21	15	20	126	188	40	11671	1.23	16
	Q3/95	3988	776	166	62	36	5	2	63	50	15	5163	1.26	6
	No observations conducted Q4/95 - Q2/96												--	
	Q3/96	8277	830	86	35	16	17	16	109	161	27	9574	1.12	16
	No observations conducted Q4/96 - Q1/98												--	

210

On ramp	Q3/92	7164	1251	158	28	0	0	5	54	20	28	8708	1.19	15
	Q4/92	3422	402	23	7	0	0	0	55	8	13	3930	1.12	7
	Q1/93	No observations											--	
	Q2/93	No observations											--	
	Q3/93	3064	740	107	58	2	0	2	35	3	30	4041	1.29	10
	Q4/93	1576	324	41	18	0	0	6	28	3	6	2002	1.24	7
	Q1/94	1797	408	66	25	3	0	8	13	3	7	2330	1.27	6
	Q2/94	1624	377	77	35	2	0	5	23	2	10	2155	1.30	5
	Q3/94	3426	794	153	55	16	0	0	22	3	37	4506	1.29	12
	Q4/94	3322	551	65	20	2	1	14	32	2	7	4018	1.19	11
	Q1/95	3485	718	93	27	7	0	17	38	3	5	4393	1.23	11
	Q2/95	1565	334	65	20	2	0	6	12	3	11	2018	1.27	6
	Q3/95	No observations											--	

90

**SITE #22. I-5 DOWNTOWN - S. Holgate Street**

**▲ ACO Mainline SB & NB-am & pm**

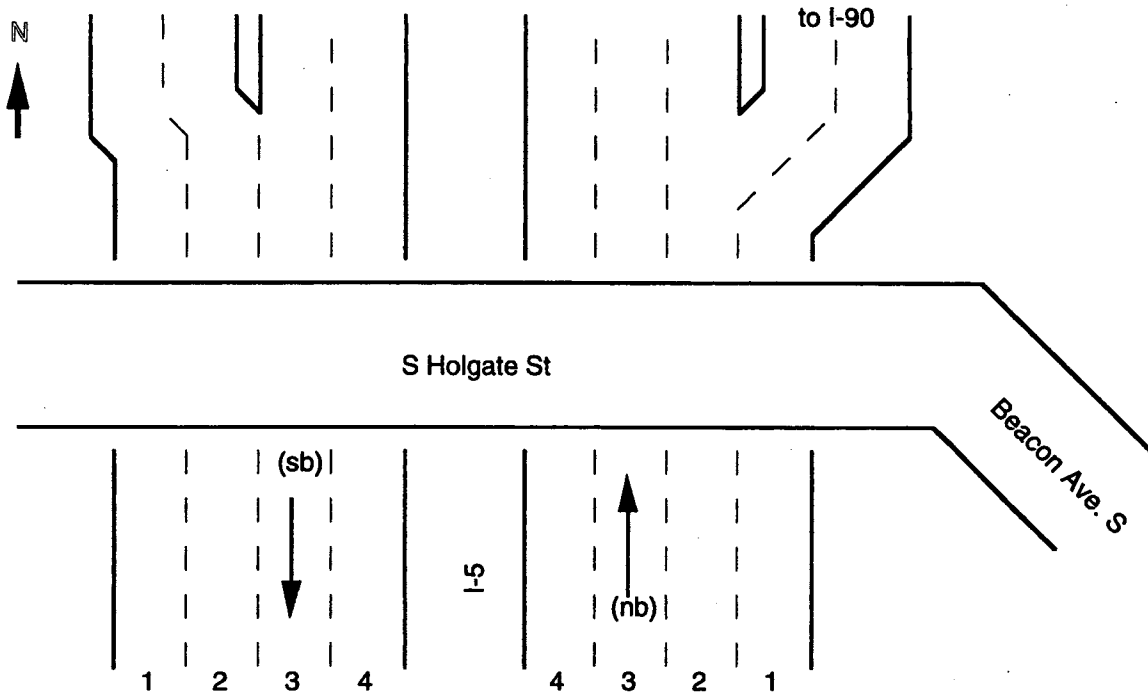

**Note:** There is a sidewalk only on the north side of Holgate over the freeway, so counting northbound travel times must be done with traffic moving away from you. The southbound lanes are on a considerably lower level than the northbound lanes, and are consequently somewhat harder to see.

Observations at site discontinued Q4/92.

**a.m. southbound**

	Qtr.	1	2	3	4+	Van	Public Transit	Other Bus	2 Axle	3+ Axle	Motor- cycle	TOTAL OBS.	ACO	Counts
GP	Q3/92	4751	625	23	5	14	41	8	90	126	11	5694	1.13	8
lanes 4	Q4/92	3292	312	19	7	2	58	10	95	111	7	3913	1.10	6
														14

**p.m. southbound**

	Qtr.	1	2	3	4+	Van	Public Transit	Other Bus	2 Axle	3+ Axle	Motor- cycle	TOTAL OBS.	ACO	Counts
GP	Q3/92	12011	3874	529	87	16	30	43	252	371		10317316	1.32	24
lanes 4	Q4/92	7108	1689	144	61	17	12	21	182	194		309458	1.24	16
														40

**I-5 DOWNTOWN - S. Holgate Street**

**a.m. northbound**

	Qtr.	1	2	3	4+	Van	Public Transit	Other Bus	2 Axle	3+ Axle	Motor- cycle	TOTAL OBS.	ACO	Counts
GP	Q3/92	2436	436	33	21	8	4	7	73	103	13	3134	1.19	6
lanes 4	Q4/92	1246	310	28	4	13	10	34	78	70	11	1804	1.24	4
														10

**p.m. northbound**

	Qtr.	1	2	3	4+	Van	Public Transit	Other Bus	2 Axle	3+ Axle	Motor- cycle	TOTAL OBS.	ACO	Counts
GP	Q3/92	2762	602	64	25	7	7	6	55	81	37	3646	1.24	5
lanes 4	Q4/92	No observations											--	
														5

**SITE #23. I-5 DOWNTOWN - Michigan St.**

- ACO onramp NB-am
- ACO onramp NB-pm

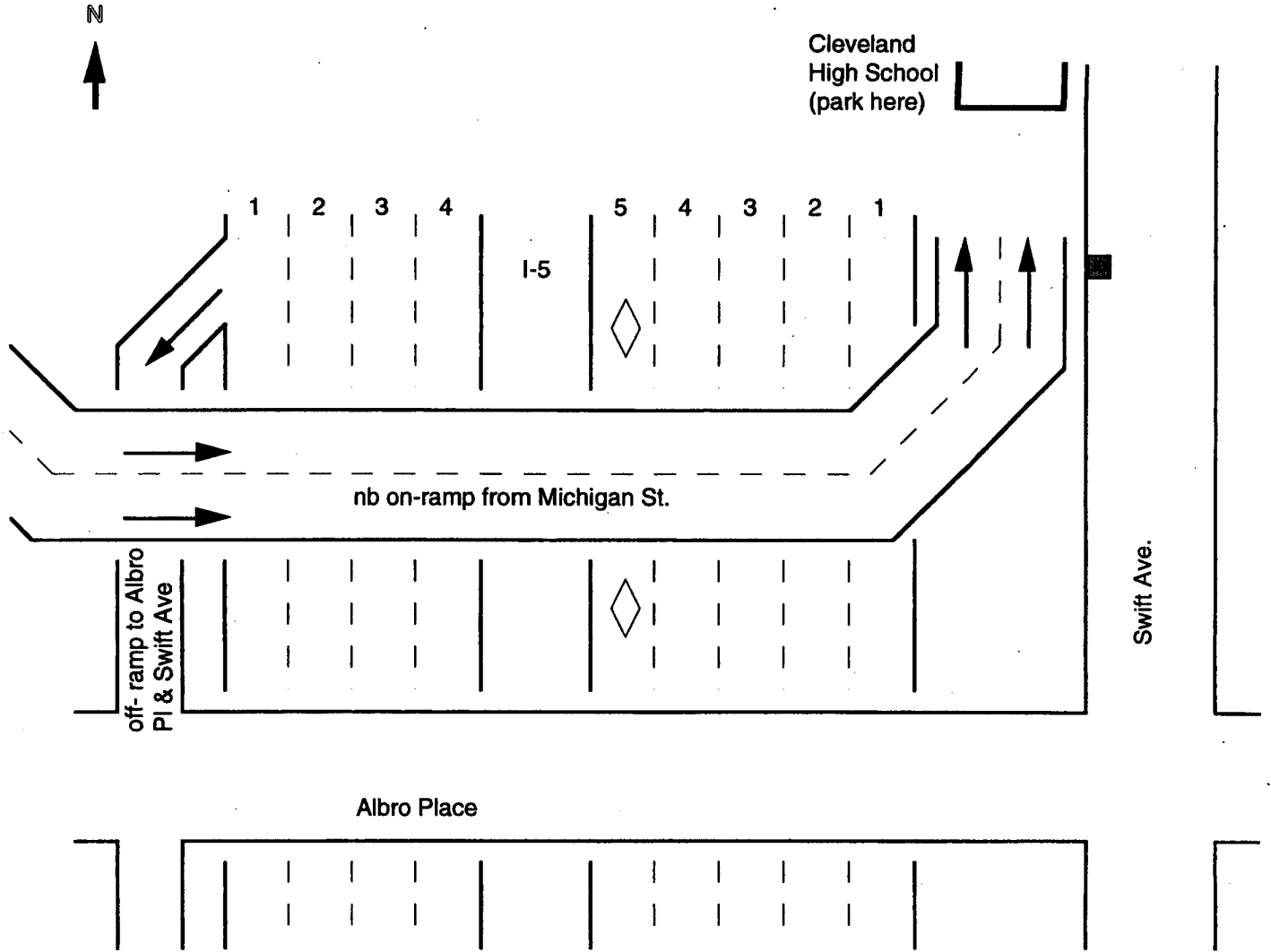

**I-5 DOWNTOWN - Michigan St.**

**a.m. northbound**

	Qtr.	1	2	3	4+	Van	Public Transit	Other Bus	2 Axle	3+ Axle	Motor- cycle	TOTAL OBS.	ACO	Counts
On ramp	Q3/92	2037	414	62	14	3	5	23	152	152	18	2880	1.23	8
	Q4/92	2096	299	41	17	18	12	8	48	56	7	2602	1.18	10
	Q1/93	1264	336	41	13	5	4	0	17	14	2	1696	1.28	4
														22

**p.m. northbound**

	Qtr.	1	2	3	4+	Van	Public Transit	Other Bus	2 Axle	3+ Axle	Motor- cycle	TOTAL OBS.	ACO	Counts
On ramp	Q3/92	5550	654	100	37	20	22	9	67	116	41	6616	1.15	15
	Q4/92	2096	299	41	17	18	12	8	48	56	7	2602	1.18	7
	Q1/93	1264	336	41	13	5	4	0	17	14	2	1696	1.28	4
														26

**SITE #24. I-5 DOWNTOWN - Corson Avenue S.**

- ACO offramp SB-am
- ACO offramp SB-pm

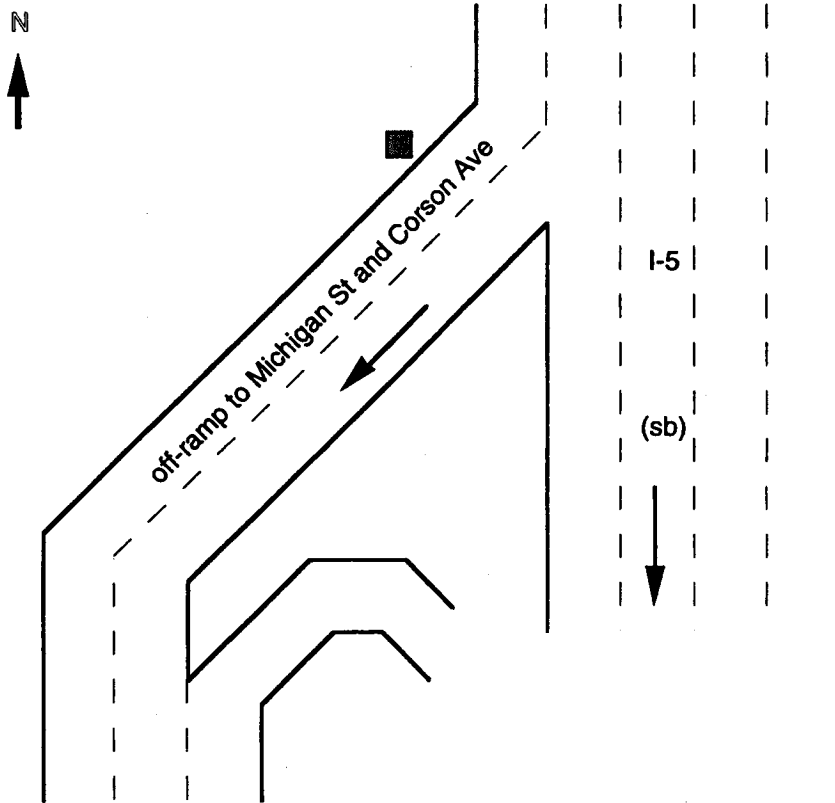

**Note: Observations at site discontinued Q1/93.**

**a.m. southbound**

	Qtr.	1	2	3	4+	Van	Public Transit	Other Bus	2 Axle	3+ Axle	Motor- cycle	TOTAL OBS.	ACO	Counts
Off ramp	Q3/92	2332	198	22	5	1	9	4	43	112	12	2738	1.10	8
	Q4/92	1060	44	1	0	0	3	2	31	29	3	1173	1.04	2
	Q1/93	No observations											--	

10

**p.m. southbound**

	Qtr.	1	2	3	4+	Van	Public Transit	Other Bus	2 Axle	3+ Axle	Motor- cycle	TOTAL OBS.	ACO	Counts
Off ramp	Q3/92	1610	359	35	28	6	5	29	41	119	19	2251	1.25	9
	Q4/92	808	185	27	17	2	2	17	68	41	4	1171	1.28	4
	Q1/93	No observations											--	

13



**SITE #25. I-5 DOWNTOWN - Albro Place**

**ACO mainline SB & NB-am & pm**

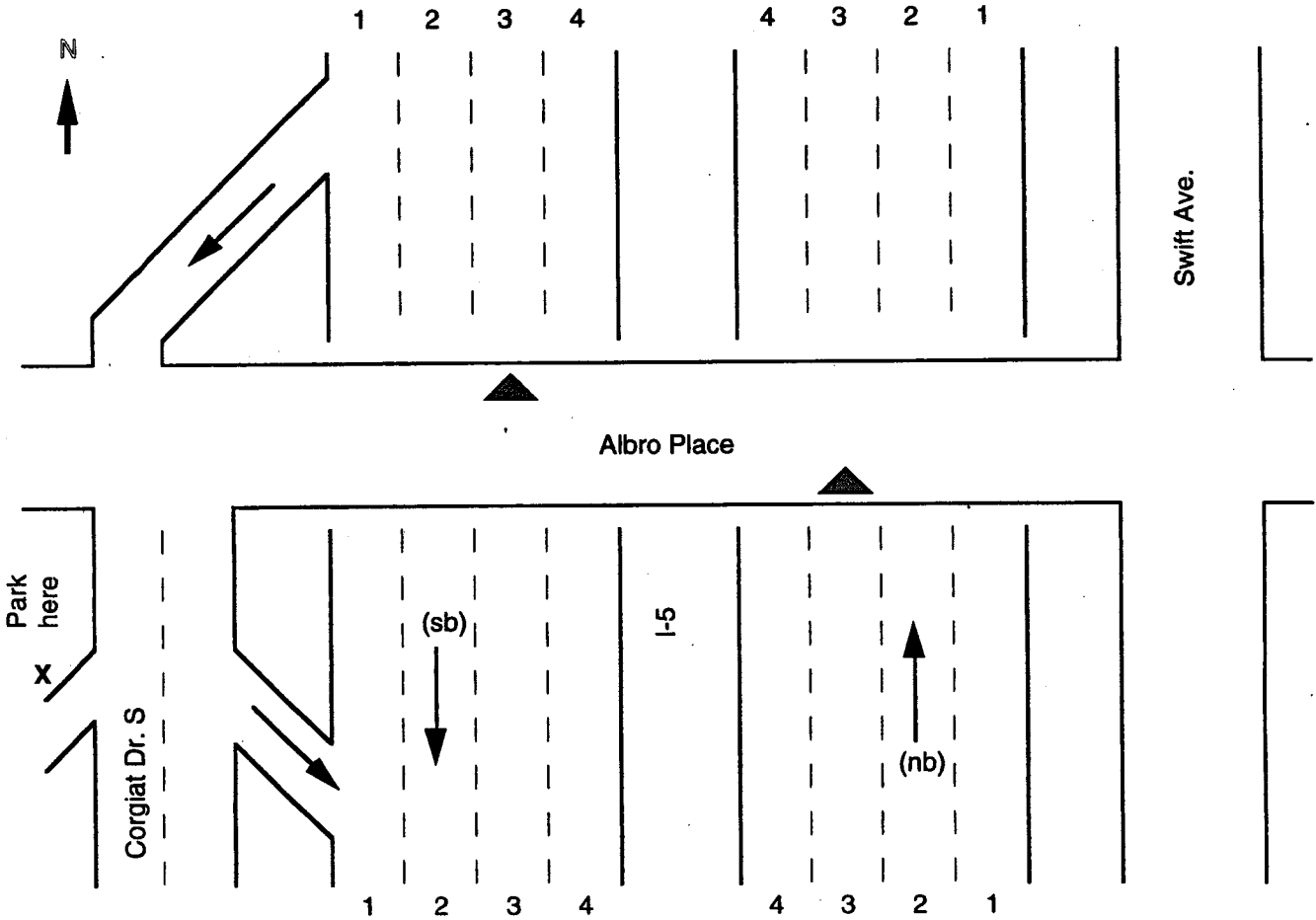

**Note:** Prior to 11-9-93, the HOV lanes northbound ended about a hundred yards south of this overpass. The southbound HOV lanes end about a hundred yards to the north of this overpass. For data after Q3/93, see following pages.

### I-5 Downtown - Albro Place

#### a.m. northbound

	Qtr.	1	2	3	4+	Van	Public Transit	Other Bus	2 Axle	3+ Axle	Motor- cycle	TOTAL OBS.	ACO	Counts
GP lanes	Q3/92	No observations											--	
	Q4/92	No observations											--	
4	Q1/93	2475	505	3	1	1	40	5	100	114	1	3245	1.17	6
	Q2/93	2436	369	30	11	2	16	8	69	108	5	3054	1.16	4
	Q3/93	9093	1580	152	54	21	110	24	328	413	43	11818	1.19	18
														28

#### p.m. northbound

	Qtr.	1	2	3	4+	Van	Public Transit	Other Bus	2 Axle	3+ Axle	Motor- cycle	TOTAL OBS.	ACO	Counts
GP lanes	Q3/92	No observations											--	
	Q4/92	No observations											--	
4	Q1/93	No observations											--	
	Q2/93	7014	1863	256	101	12	55	24	216	287	13	9841	1.29	21
	Q3/93	10331	3194	629	317	19	81	33	419	360	46	15429	1.38	24
														45

#### a.m. southbound

	Qtr.	1	2	3	4+	Van	Public Transit	Other Bus	2 Axle	3+ Axle	Motor- cycle	TOTAL OBS.	ACO	Counts
GP lanes	Q3/92	No observations											--	
	Q4/92	No observations											--	
4	Q1/93	No observations											--	
	Q2/93	1939	333	66	9	1	28	1	62	65	15	2519	1.21	4
	Q3/93	8473	1468	207	58	20	164	36	288	355	43	11112	1.20	19
														23

#### p.m. southbound

	Qtr.	1	2	3	4+	Van	Public Transit	Other Bus	2 Axle	3+ Axle	Motor- cycle	TOTAL OBS.	ACO	Counts
GP lanes	Q3/92	1853	448	65	47	8	13	11	49	49	9	2552	1.30	3
	Q4/92	No observations											--	
4	Q1/93	2380	606	11	2	0	42	4	80	113	3	3241	1.21	5
	Q2/93	7126	2479	151	62	14	98	11	171	224	22	10358	1.30	14
	Q3/93	9487	3071	353	161	17	121	29	312	346	52	13949	1.33	19
														41

**I-5 Downtown - Albro Place**

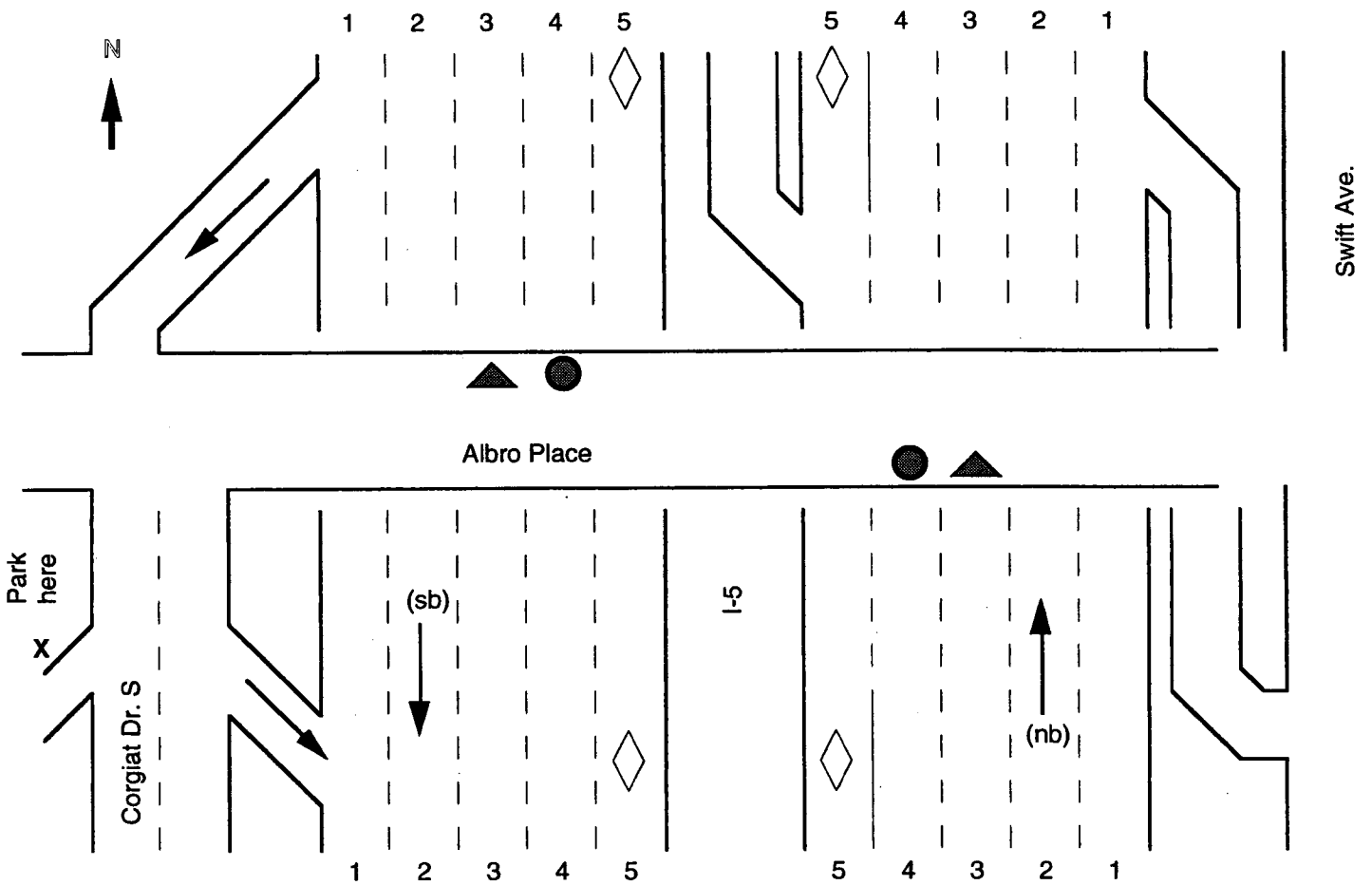

Note: For data prior to Q4/93 see the preceding pages.

**a.m. northbound**

	Qtr.	1	2	3	4+	Van	Public Transit	Other Bus	2 Axle	3+ Axle	Motor- cycle	TOTAL OBS.	ACO	Counts
HOV/ exit lane 1	Q4/93	No observations											--	
	Q1/94	176	121	18	4	1	2	2	6	7	5	342	1.53	2
	Q2/94	432	457	94	23	8	7	5	25	21	22	1094	1.71	3
	Q3/94	364	428	67	10	5	4	2	17	17	14	928	1.68	3
	Q4/94	509	519	35	5	3	20	6	19	15	2	1133	1.57	2
	Q1/95	575	1571	133	17	10	28	5	37	42	23	2441	1.82	6
	Q2/95	3017	2877	142	33	52	83	31	66	101	125	6527	1.54	13
	Q3/95	643	897	22	13	19	35	9	27	65	53	1783	1.62	7
	No observations conducted Q4/95 - Q2/96												--	
	Q3/96	1225	1528	88	30	45	57	5	44	59	36	3117	1.63	9
	No observations conducted Q4/96 - Q1/97												--	
	Q2/97	2090	4182	294	53	111	110	18	86	90	74	7108	1.75	11
	Q3/97	1875	3772	251	88	97	114	36	86	63	77	6459	1.76	11
	No observations conducted Q4/97 - Q1/98												--	
	Q2/98	2852	5042	428	63	110	199	48	213	133	49	9138	1.73	14

### I-5 Downtown - Albro Place

#### a.m. northbound

	Qtr.	1	2	3	4+	Van	Public Transit	Other Bus	2 Axle	3+ Axle	Motor- cycle	TOTAL OBS.	ACO	Counts	
GP lanes 4	Q4/93	5016	605	40	28	5	73	7	234	217	6	6231	1.14	11	
	Q1/94	6939	741	66	16	8	63	5	284	159	9	8290	1.12	13	
	Q2/94	7018	1182	173	40	15	60	8	262	236	26	9020	1.20	12	
	Q3/94	7501	1094	136	20	21	75	4	314	303	33	9501	1.16	13	
	Q4/94	3170	762	53	9	6	58	9	179	253	2	4501	1.22	7	
	Q1/95	4027	395	33	3	0	27	7	169	267	4	4932	1.11	10	
	Q2/95	2729	244	14	8	5	29	10	132	183	9	3363	1.10	13	
	Q3/95	2719	227	13	12	10	33	5	97	171	9	3296	1.10	12	
	No observations conducted Q4/95 - Q2/96												--		
	Q3/96	1830	171	10	7	4	34	1	73	146	2	2278	1.11	6	
	No observations conducted Q4/96 - Q1/97												--		
	Q2/97	4096	163	9	3	6	37	18	134	267	2	4735	1.04	9	
	Q3/97	4567	348	16	13	13	26	4	119	162	3	5271	1.09	9	
	No observations conducted Q4/97 - Q1/98												--		
Q2/98	10015	556	34	22	4	43	15	455	508	6	11658	1.07	19		
134															

#### p.m. northbound

	Qtr.	1	2	3	4+	Van	Public Transit	Other Bus	2 Axle	3+ Axle	Motor- cycle	TOTAL OBS.	ACO	Counts	
HOV/ exit lane 1	Q3/93	98	16	1	4	0	0	0	4	3	0	126	1.26	2	
	Q4/93	61	91	28	9	4	2	1	6	3	1	206	1.93	1	
	Q1/94	322	561	98	31	14	32	6	16	15	9	1104	1.85	3	
	Q2/94	270	761	111	34	24	16	18	16	25	14	1289	1.93	4	
	Q3/94	382	971	157	67	39	85	4	37	28	39	1809	1.95	5	
	Q4/94	102	420	44	16	11	36	9	8	8	8	662	1.96	3	
	Q1/95	857	2265	269	86	58	196	31	64	72	25	3923	1.89	9	
	Q2/95	906	1863	176	44	54	210	25	79	61	68	3486	1.79	11	
	Q3/95	654	1132	97	18	60	166	17	67	65	26	2302	1.73	8	
	No observations conducted Q4/95 - Q2/96												--		
	Q3/96	1880	388	64	23	11	29	1	73	136	8	2613	1.25	8	
	No observations conducted Q4/96 - Q1/97												--		
	Q2/97	373	2372	224	39	48	178	13	68	36	26	3377	1.98	8	
	Q3/97	1139	3070	581	223	95	231	33	51	53	82	5558	1.99	11	
No observations conducted Q4/97 - Q1/98												--			
Q2/98	2920	6650	711	207	124	398	103	212	154	139	11618	1.83	18		
91															

**I-5 Downtown - Albro Place**

<b>p.m.</b>		<b>northbound</b>												
GP lanes 4	Q4/93	5101	1309	193	85	19	56	11	160	184	9	7127	1.29	17
	Q1/94	7102	1863	324	90	27	79	10	197	261	15	9968	1.30	15
	Q2/94	7412	2149	276	114	33	84	41	194	275	21	10599	1.31	18
	Q3/94	6120	2175	282	117	50	129	13	151	223	67	9327	1.36	17
	Q4/94	5201	939	104	58	25	87	19	165	168	13	6799	1.21	11
	Q1/95	6459	803	28	15	1	48	8	129	220	4	7715	1.12	16
	Q2/95	5849	1197	88	32	2	37	8	137	176	16	7542	1.21	13
	Q3/95	4700	283	42	17	7	10	6	68	104	14	5251	1.08	9
	No observations conducted Q4/95 - Q2/96												--	
	Q3/96	1880	388	64	23	11	29	1	73	136	8	2613	1.25	8
	No observations conducted Q4/96 - Q1/97												--	
	Q2/97	4309	809	56	26	20	1	1	48	42	4	5316	1.19	7
	Q3/97	2983	773	99	63	13	23	2	72	155	17	4200	1.30	8
	No observations conducted Q4/97 - Q1/98													
	Q2/98	5123	920	80	17	3	36	6	143	235	21	6584	1.18	12
<b>151</b>														

<b>a.m.</b>		<b>southbound</b>										TOTAL	ACO	Counts
	Qtr.	1	2	3	4+	Van	Public Transit	Other Bus	2 Axle	3+ Axle	Motor- cycle	OBS.		
HOV lanes 1	Q2/97	4	194	37	3	17	26	5	4	0	4	294	2.17	4
	Q3/97	73	2212	192	92	103	135	19	18	2	50	2896	2.13	11
	No observations conducted Q4/97 - Q1/98													
	Q2/98	89	2553	300	66	78	215	65	52	4	47	3469	2.12	16
<b>31</b>														
GP lanes 4	Q4/93	4468	448	48	30	4	97	16	132	179	5	5427	1.13	12
	Q1/94	5959	739	82	16	9	112	19	190	274	8	7408	1.14	14
	Q2/94	6063	780	49	29	4	118	17	171	314	14	7559	1.14	18
	Q3/94	6043	812	84	39	23	118	16	152	252	33	7572	1.16	17
	Q4/94	3752	405	30	8	12	71	14	120	183	8	4603	1.12	10
	Q1/95	3785	405	21	5	13	55	15	89	210	6	4604	1.11	10
	Q2/95	6696	850	77	14	16	141	14	200	303	47	8358	1.14	16
	Q3/95	3131	264	33	40	9	46	10	68	105	16	3722	1.13	11
	No observations conducted Q4/95 - Q2/96												--	
	Q3/96	2794	175	18	23	15	60	6	62	110	11	3274	1.09	10
	No observations conducted Q4/96 - Q1/97												--	
	Q2/97	6836	561	49	22	44	128	20	170	358	23	8211	1.10	18
Q3/97	2606	161	10	5	4	85	6	69	199	6	3151	1.07	8	
No observations conducted Q4/97 - Q1/98														
Q2/98	7112	508	31	6	20	103	13	247	395	8	8443	1.08	16	
<b>160</b>														

**I-5 Downtown - Albro Place**

**p.m. southbound**

	Qtr.	1	2	3	4+	Van	Public Transit	Other Bus	2 Axle	3+ Axle	Motor- cycle	TOTAL OBS.	ACO	Counts
HOV lanes 1	Q2/97	348	2319	229	129	51	41	9	11	0	29	3166	2.05	5
	Q3/97	543	3836	653	261	125	87	19	32	26	97	5679	2.13	12
	No observations conducted Q4/97 - Q1/98													
	Q2/98	196	8029	1060	273	97	311	96	143	0	97	10302	2.15	18
														35
GP lanes 4	Q4/93	7551	1988	264	62	27	98	18	253	251	17	10511	1.27	14
	Q1/94	6970	2002	301	176	25	77	13	255	260	21	10100	1.34	14
	Q2/94	10871	2992	305	184	33	140	18	336	374	27	15280	1.29	21
	Q3/94	10113	2920	498	321	49	132	21	383	463	40	14945	1.36	21
	Q4/94	7243	1588	156	50	39	93	10	231	326	14	9750	1.23	14
	Q1/95	7925	1059	83	41	39	81	20	250	267	5	9770	1.15	14
	Q2/95	8701	3615	275	124	69	129	23	286	376	76	13674	1.36	21
	Q3/95	9670	2095	269	112	80	90	10	281	369	54	13030	1.25	16
	No observations conducted Q4/95 - Q2/96												--	
	Q3/96	7254	1434	176	88	52	86	22	178	318	53	9661	1.23	16
	No observations conducted Q4/96 - Q1/97												--	
	Q2/97	4533	1419	57	21	24	43	4	143	154	25	6423	1.27	9
	Q3/97	6113	1098	97	51	24	65	7	170	281	15	7921	1.20	13
	No observations conducted Q4/97 - Q1/98													
Q2/98	7242	994	109	20	8	29	10	266	271	12	8961	1.15	15	
														188

**SITE #26. I-5 DOWNTOWN - South 144th St.**

**ACO Mainline NB am & SB pm**

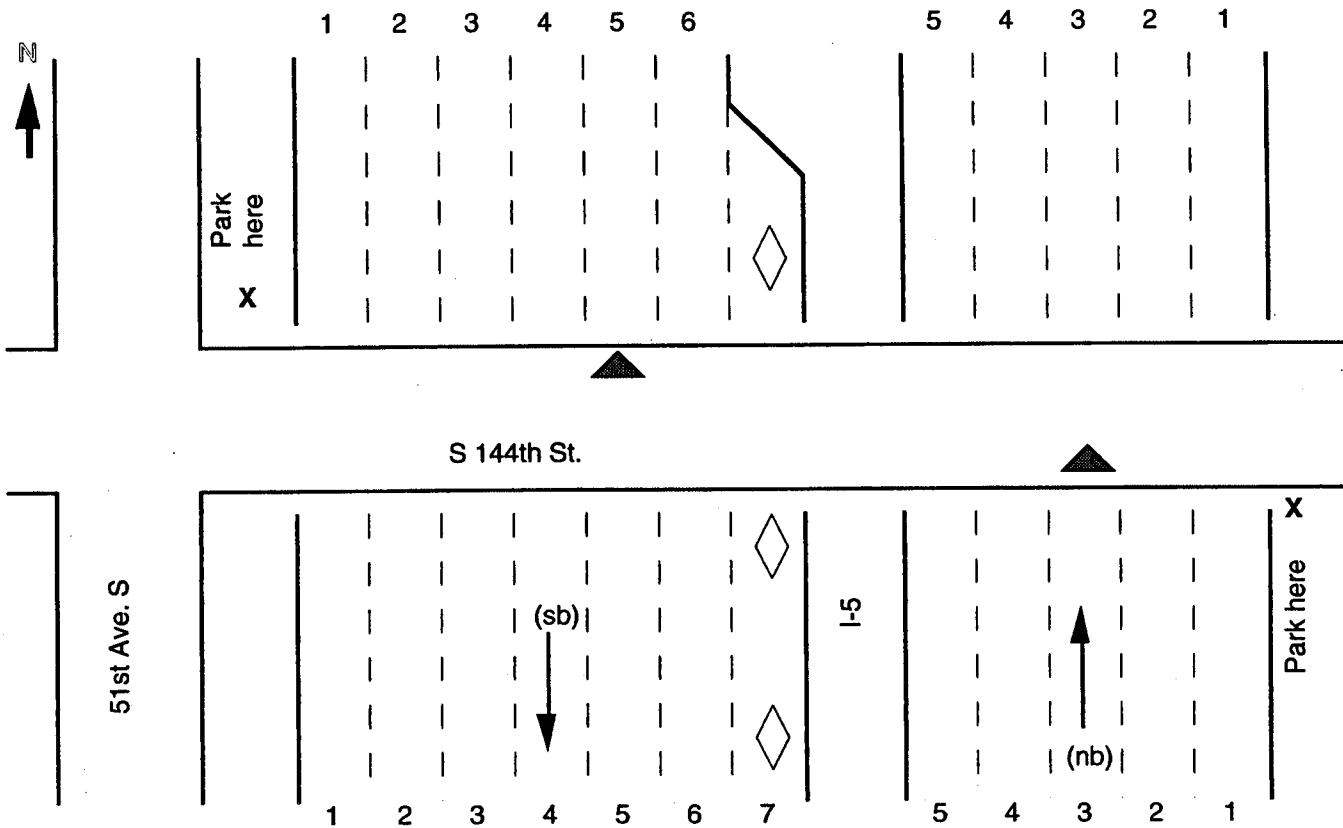

Note: Observations at site discontinued Q1/93.

**a.m. northbound**

	Qtr.	1	2	3	4+	Van	Public Transit	Other Bus	2 Axle	3+ Axle	Motor- cycle	TOTAL OBS.	ACO	Counts
GP	Q3/92	6015	1039	127	36	10	38	13	263	361	54	7956	1.20	16
lanes	Q4/92	270	14	1	0	1	1	0	5	14	2	308	1.06	1
5	Q1/93	1987	168	14	2	3	8	6	74	109	2	2373	1.09	3
														20

**p.m. southbound**

	Qtr.	1	2	3	4+	Van	Public Transit	Other Bus	2 Axle	3+ Axle	Motor- cycle	TOTAL OBS.	ACO	Counts
GP	Q3/92	5246	1212	246	99	16	47	12	158	253	44	7333	1.30	14
lanes	Q4/92	No observations											--	
6	Q1/93	No observations											--	
														14

**SITE #27 I-5 DOWNTOWN - Olive Street**

■ ACO on/ramp NB-am & pm

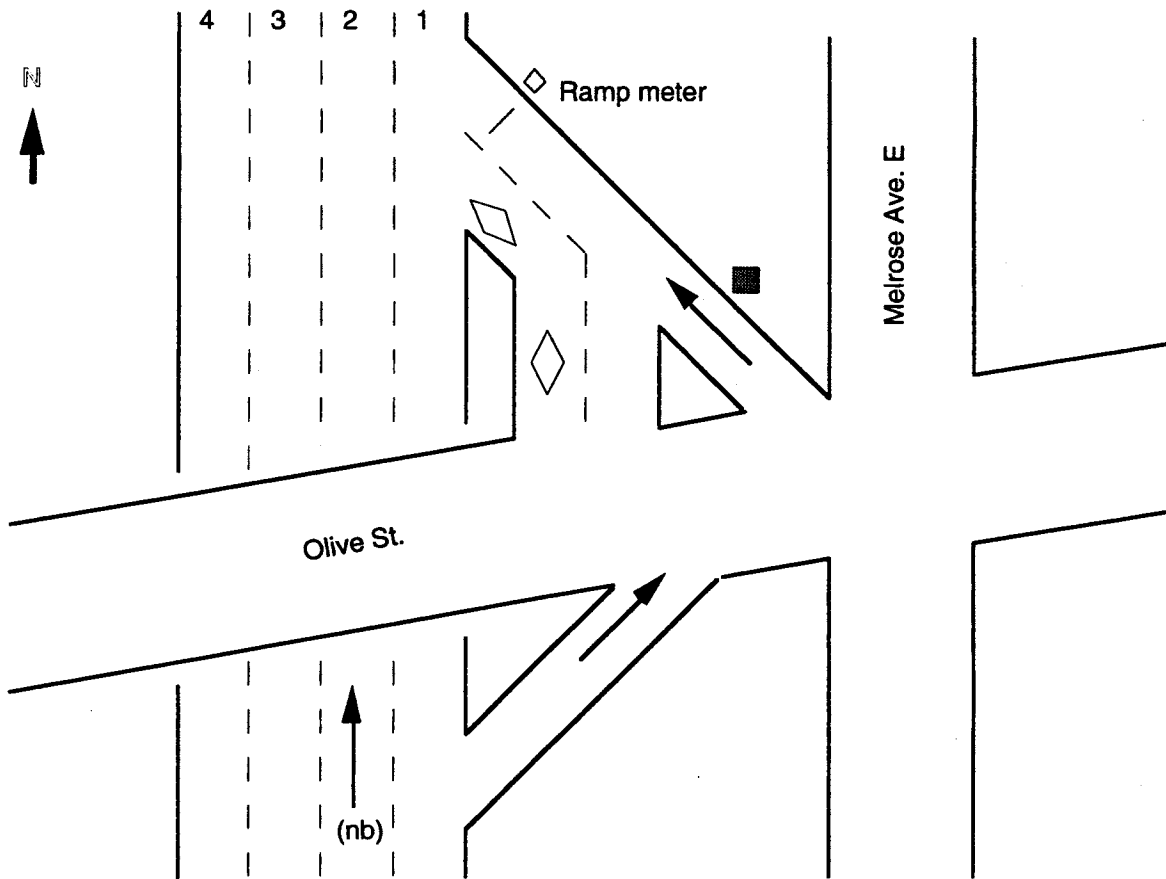

**a.m. northbound**

	Qtr.	1	2	3	4+	Van	Public Transit	Other Bus	2 Axle	3+ Axle	Motor- cycle	TOTAL OBS.	ACO	Counts
On ramp	Q3/92	No observations											--	
	Q4/92	2258	500	32	4	1	3	5	24	6	0	2833	1.21	4
	Q1/93	4006	522	45	15	9	520	33	36	12	12	5210	1.14	19
	Q2/93	1051	111	14	8	0	122	11	11	5	8	1341	1.14	5
	Q3/93	No observations											--	
	Q4/93	938	130	18	6	4	125	4	14	4	0	1243	1.17	4
	Q1/94	1757	190	19	5	2	201	16	19	4	7	2220	1.12	7
	Q2/94	1818	170	24	6	2	234	17	25	5	10	2311	1.12	4
	Q3/94	1119	143	19	5	0	139	13	11	2	10	1461	1.15	10
	Q4/94	734	68	7	4	1	130	5	14	3	0	966	1.12	5
	Q1/95	1375	120	13	0	1	176	6	21	5	6	1723	1.10	7
	Q2/95	1353	91	15	3	3	237	18	25	4	8	1757	1.09	11
	Q3/95	No observations											--	



**I-5 Downtown - Roanoke Blvd.**

p.m.	northbound											TOTAL OBS.	ACO	Counts
	Qtr.	1	2	3	4+	Van	Public Transit	Other Bus	2 Axle	3+ Axle	Motor- cycle			
On ramp	Q3/92	2041	441	72	21	1	51	4	14	3	12	2660	1.25	4
	Q4/92	1522	299	21	5	1	44	4	14	2	3	1915	1.19	3
	Q1/93	8443	1649	195	76	2	335	15	626	11	31	11383	1.22	21
	Q2/93	3407	766	138	54	0	123	4	668	2	21	5183	1.28	10
	Q3/93	1223	292	53	32	0	21	1	16	0	8	1646	1.31	5
	Q4/93	4579	931	123	41	0	138	2	34	7	15	5870	1.23	10
	Q1/94	2144	440	73	21	3	57	3	15	1	3	2760	1.24	5
	Q2/94	2149	519	97	36	0	75	7	23	1	17	2924	1.30	5
	Q3/94	3469	823	116	90	1	134	7	32	0	24	4696	1.30	8
	Q4/94	4811	438	39	13	4	141	3	38	3	9	5499	1.11	10
Q1/95	5106	770	79	19	7	138	3	41	4	16	6183	1.17	10	
Q2/95	4100	957	98	50	13	115	9	46	5	15	5408	1.25	10	
Q3/95	No observations											--		

**SITE #28. I-5 DOWNTOWN - Howell/Yale Streets**

■ ACO on/ramp SB-am & pm

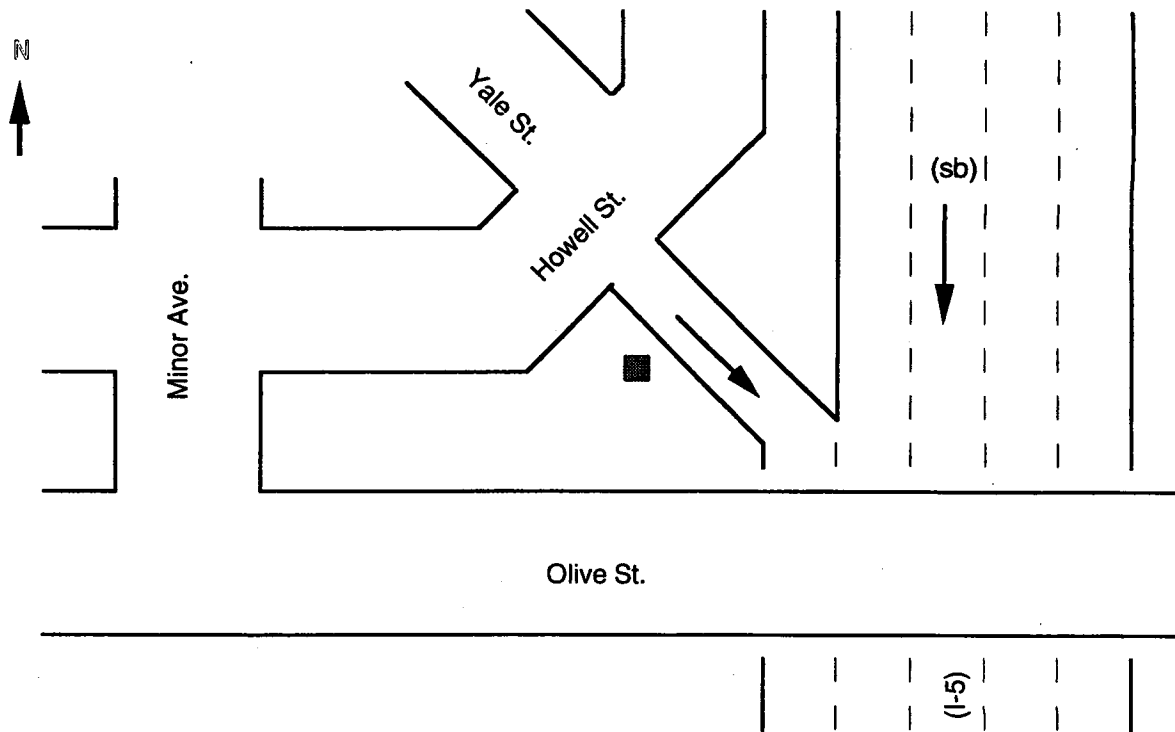

**Note:** It is okay to park in the loading zone, as long as you try to stay away from the docks and out of the way as much as possible. It is a good idea to leave a big note on your dashboard that you are counting at the ramp, in case your car needs to be moved.

**a.m. southbound**

	Qtr.	1	2	3	4+	Van	Public Transit	Other Bus	2 Axle	3+	Motor- cycle	TOTAL OBS.	ACO	Counts
On ramp	Q3/92	No observations											--	
	Q4/92	No observations											--	
	Q1/93	1099	123	8	0	1	147	4	36	15	0	1433	1.11	4
	Q2/93	1510	211	34	17	0	173	7	42	19	8	2021	1.19	5
	Q3/93	No observations											--	
	Q4/93	801	37	5	3	0	92	4	18	6	1	967	1.07	3
	Q1/94	2466	235	21	23	2	231	17	64	11	9	3079	1.13	7
	Q2/94	1269	135	19	8	0	135	10	34	5	5	1620	1.14	4
	Q3/94	975	114	6	13	1	148	5	21	11	5	1299	1.15	5
	Q4/94	2211	236	26	11	5	230	5	27	9	2	2762	1.13	6
	Q1/95	2371	239	25	4	6	243	5	33	10	7	2943	1.11	7
	Q2/95	2417	269	35	18	1	235	10	54	25	24	3088	1.14	11
Q3/95	No observations											--		

## I-5 DOWNTOWN - Howell/Yale Streets

p.m.	southbound											TOTAL OBS.	ACO	Counts
	Qtr.	1	2	3	4+	Van	Public Transit	Other Bus	2 Axle	3+ Axle	Motor- cycle			
On ramp	Q3/92	1967	409	54	21	2	3	7	16	2	9	2490	1.24	3
	Q4/92	4757	1158	162	69	4	6	22	48	9	15	6250	1.28	11
	Q1/93	12106	2555	290	124	16	7	64	824	19	30	16034	1.23	25
	Q2/93	5017	1229	152	87	8	17	15	78	8	33	6644	1.28	10
	Q3/93	5806	1363	248	178	10	4	21	93	17	34	7774	1.32	12
	Q4/93	2245	589	90	29	7	3	8	5	4	9	2989	1.29	3
	Q1/94	2712	556	61	19	5	4	15	58	7	6	3443	1.22	5
	Q2/94	2425	683	125	43	27	10	8	34	0	18	3373	1.33	4
	Q3/94	5812	1498	328	145	54	17	3	95	12	48	8012	1.34	12
	Q4/94	5409	917	104	66	10	2	24	92	14	9	6647	1.21	11
Q1/95	5706	986	106	23	25	1	19	79	14	21	6980	1.19	11	
Q2/95	5516	1361	179	61	10	3	15	85	7	46	7283	1.27	11	
Q3/95	No observations											--		

118

**SITE #29. I-5 DOWNTOWN - Madison Street**

- ▲ ACO mainline SB-am & pm
- ACO off/ramp NB-am

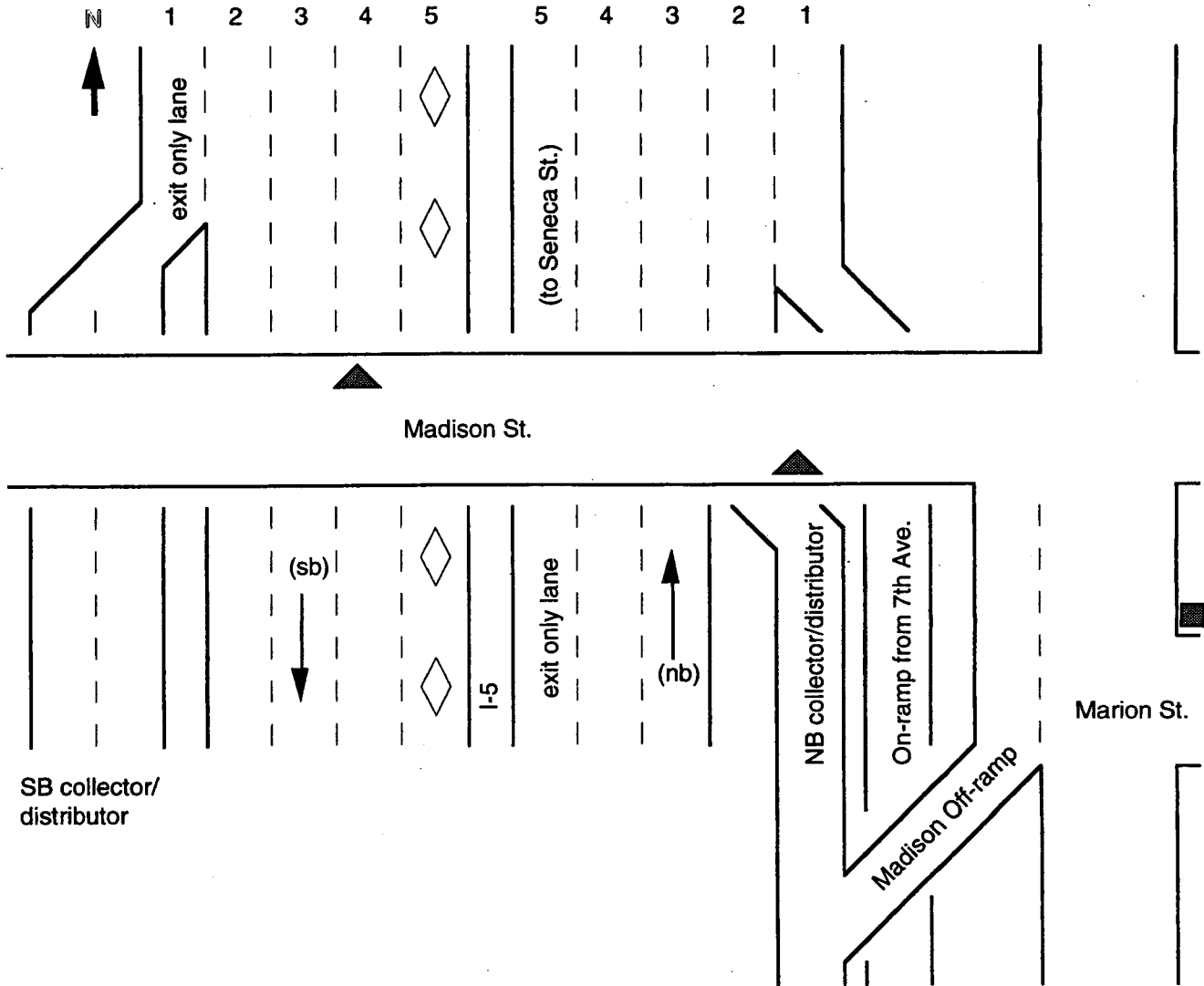

**Note:** The southbound mainline site was observed by special request to evaluate HOV lane effectiveness. SB HOV lane went from 3+ persons to 2+ persons 8/18/93.

Count the collector/distributor lanes at this location as lanes #1 and #2 in each direction (this is different than most other sites with collector/distributor lanes). When counting the off/ramp northbound, be sure to include only the traffic coming off the freeway, and not traffic merging from 7th Avenue.

**I-5 Downtown - Madison Street**

**a.m. northbound**

	Qtr.	1	2	3	4+	Van	Public Transit	Other Bus	2 Axle	3+ Axle	Motor- cycle	TOTAL OBS.	ACO	Counts	
Off ramp	Q3/92	No observations											--		
	Q4/92	1658	404	35	4	1	5	2	24	5	0	2138	1.23	4	
	Q1/93	11762	2251	207	36	8	19	31	114	22	12	14461	1.20	19	
	Q2/93	4855	983	93	17	6	7	15	72	19	8	6075	1.21	8	
	Q3/93	7044	1581	161	24	5	12	18	97	33	14	8989	1.22	12	
	Q4/93	No observations											--		
	Q1/94	4179	757	52	9	3	8	10	52	4	3	5077	1.18	7	
	Q2/94	1521	197	14	2	1	3	11	8	3	3	1763	1.13	4	
	Q3/94	4279	553	40	23	3	8	19	48	19	8	5000	1.14	10	
	Q4/94	1988	153	15	4	0	3	1	25	8	3	2200	1.09	7	
	Q1/95	2038	392	14	4	1	3	2	11	9	1	2475	1.18	3	
	Q2/95	4197	630	34	20	7	6	12	33	19	6	4964	1.18	10	
	Q3/95	No observations											--		
														84	

**p.m. northbound**

	Qtr.	1	2	3	4+	Van	Public Transit	Other Bus	2 Axle	3+ Axle	Motor- cycle	TOTAL OBS.	ACO	Counts	
Off ramp	Q4/93	3462	740	124	44	22	6	14	22	4	9	4447	1.26	12	
	Q1/94	1390	257	30	22	1	3	10	10	2	4	1731	1.23	5	
	Q2/94	1192	339	50	14	0	4	3	10	1	4	1617	1.30	5	
	Q3/94	3008	676	76	51	7	3	24	32	6	30	3913	1.26	10	
	Q4/94	3245	642	61	44	8	8	12	34	1	1	4056	1.23	11	
	Q1/95	1228	207	42	7	2	5	5	8	5	5	1514	1.21	4	
	Q2/95	2357	554	75	39	15	4	14	22	4	4	3088	1.27	10	
	Q3/95	No observations											--		
														57	

**a.m. southbound**

	Qtr.	1	2	3	4+	Van	Public Transit	Other Bus	2 Axle	3+ Axle	Motor- cycle	TOTAL OBS.	ACO	Counts
HOV lanes 1	Q2/93	6	16	42	31	2	14	8	1	0	7	127	3.10	6
														6
GP lanes 4	Q2/93	12624	1053	92	36	13	206	40	300	336	19	14719	1.10	21
														21

**p.m. southbound**

	Qtr.	1	2	3	4+	Van	Public Transit	Other Bus	2 Axle	3+ Axle	Motor- cycle	TOTAL OBS.	ACO	Counts
HOV lanes 1	Q2/93	245	858	192	30	52	13	22	76	2	64	1154	2.01	6
														6
GP lanes 4	Q2/93	12456	2932	77	4	14	61	22	1107	358	28	17059	1.20	24
														24

**SITE #20. I-5 DOWNTOWN - Stewart Street**

■ ACO off/ramp SB-am & pm

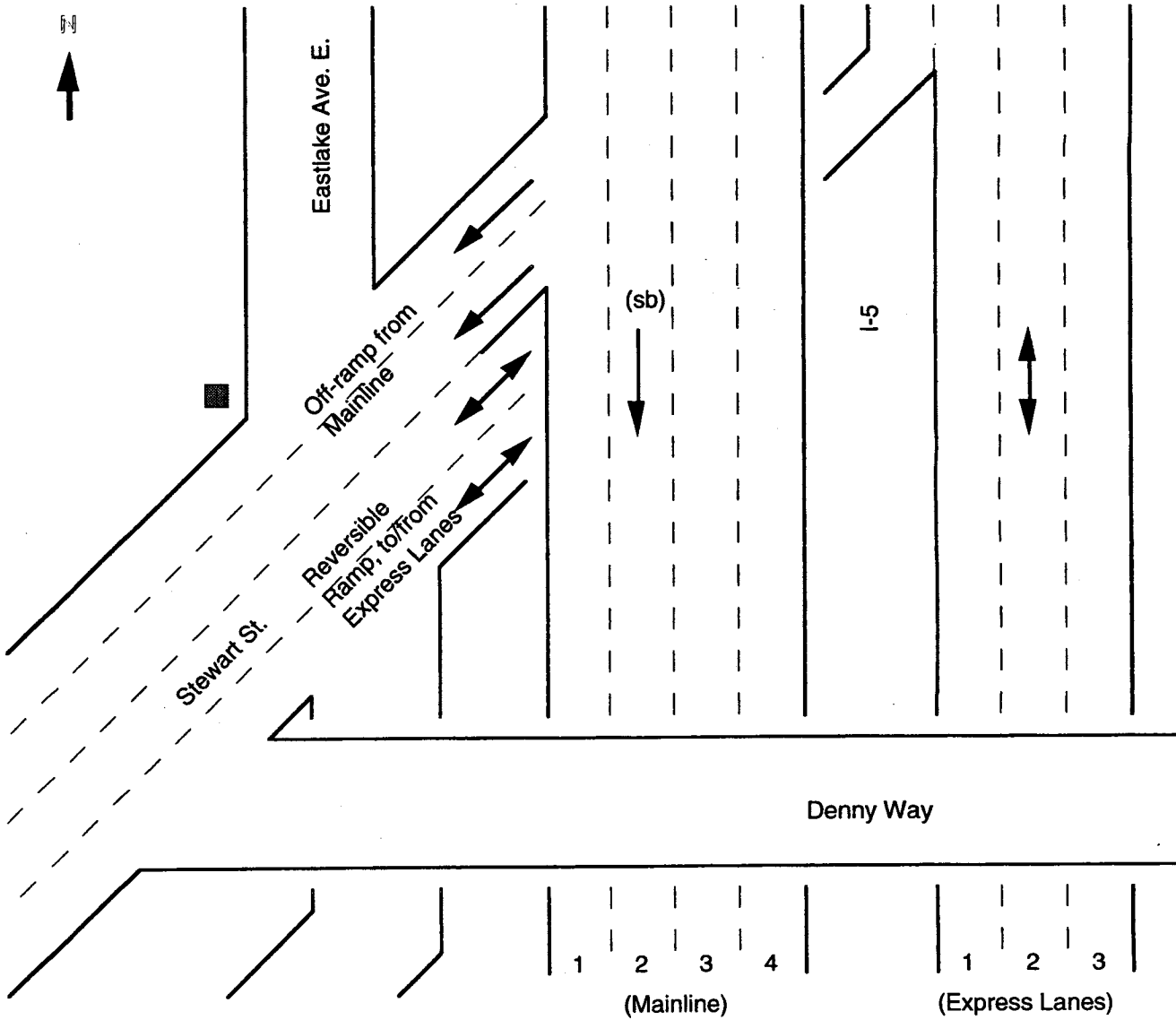

**Note:** The best place to sit is on the triangular island directly across the street from the ramp traffic as it goes through the stoplight at Eastlake Avenue. The two lanes to the north at the stoplight are traffic from the mainline, and the two lanes to the south at the stoplight are traffic from the express lanes. Do not count the express lane off/ramp traffic. Count both mainline off/ramp lanes at the same time.

**I-5 Downtown - Stewart Street**

**a.m. southbound**

	Qtr.	1	2	3	4+	Van	Public Transit	Other Bus	2 Axle	3+ Axle	Motor- cycle	TOTAL OBS.	ACO	Counts	
Off ramp	Q3/92	No observations											--		
	Q4/92	491	73	10	4	2	25	2	5	2	0	614	1.18	3	
	Q1/93	9399	1146	66	11	4	429	4	127	28	13	11227	1.12	29	
	Q2/93	5571	502	44	20	2	264	6	515	10	12	6946	1.11	17	
	Q3/93	3691	290	43	18	1	127	0	24	8	14	4216	1.11	13	
	Q4/93	No observations											--		
	Q1/94	3154	394	16	6	0	150	2	28	0	6	3756	1.12	4	
	Q2/94	4507	536	40	8	2	167	6	14	5	7	5292	1.13	5	
	Q3/94	1715	230	33	5	0	66	1	29	1	5	2085	1.16	5	
	Q4/94	3613	386	19	1	2	179	3	22	7	3	4235	1.11	7	
	Q1/95	2743	279	14	0	0	115	1	26	6	5	3189	1.10	8	
	Q2/95	3960	319	13	6	7	167	3	27	19	27	4548	1.08	11	
	Q3/95	No observations											--		

102

**p.m. southbound**

	Qtr.	1	2	3	4+	Van	Public Transit	Other Bus	2 Axle	3+ Axle	Motor- cycle	TOTAL OBS.	ACO	Counts	
Off ramp	Q3/92	No observations											--		
	Q4/92	No observations											--		
	Q1/93	No observations											--		
	Q2/93	No observations											--		
	Q3/93	No observations											--		
	Q4/93	1431	358	42	20	1	69	5	18	3	8	1955	1.27	6	
	Q1/94	1227	308	25	11	1	66	2	19	0	4	1663	1.25	5	
	Q2/94	1462	427	61	29	7	88	0	12	1	11	2098	1.32	6	
	Q3/94	2758	840	163	85	10	152	11	45	1	30	4095	1.37	11	
	Q4/94	2351	413	38	14	6	116	13	26	0	2	2979	1.19	9	
	Q1/95	2171	571	61	29	7	109	8	25	0	9	2990	1.28	8	
	Q2/95	2562	792	112	72	11	158	13	27	7	25	3779	1.35	11	
Q3/95	No observations											--			

56

**Vehicle Occupancy (ACO) Sites  
I-5 South (Corridor #3)**

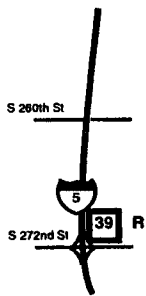
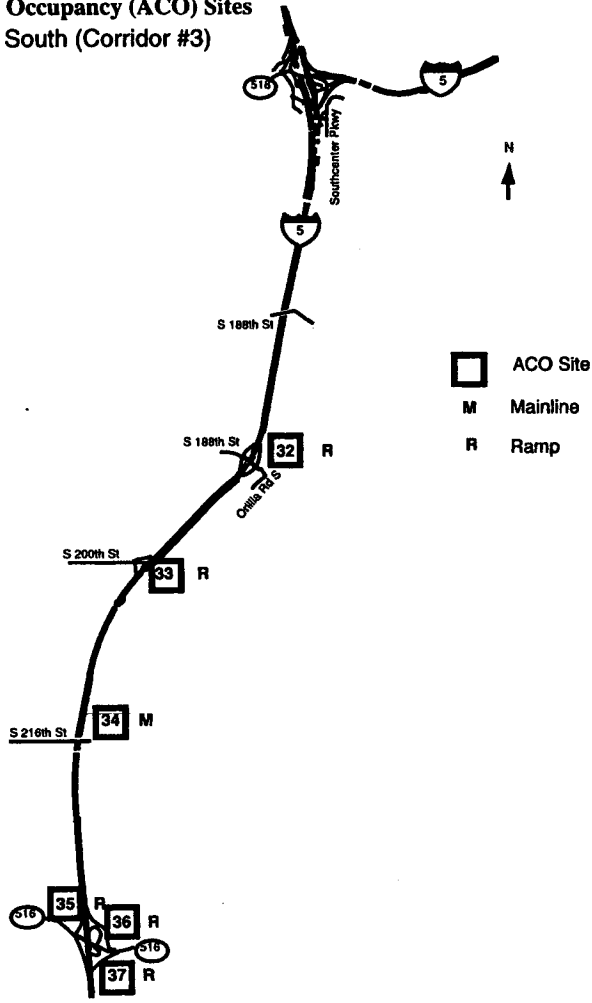



**SITE #32. I-5 SOUTH - South 188th St./Orillia Road**

- ACO on/ramp NB-am
- ACO off/ramp SB-pm

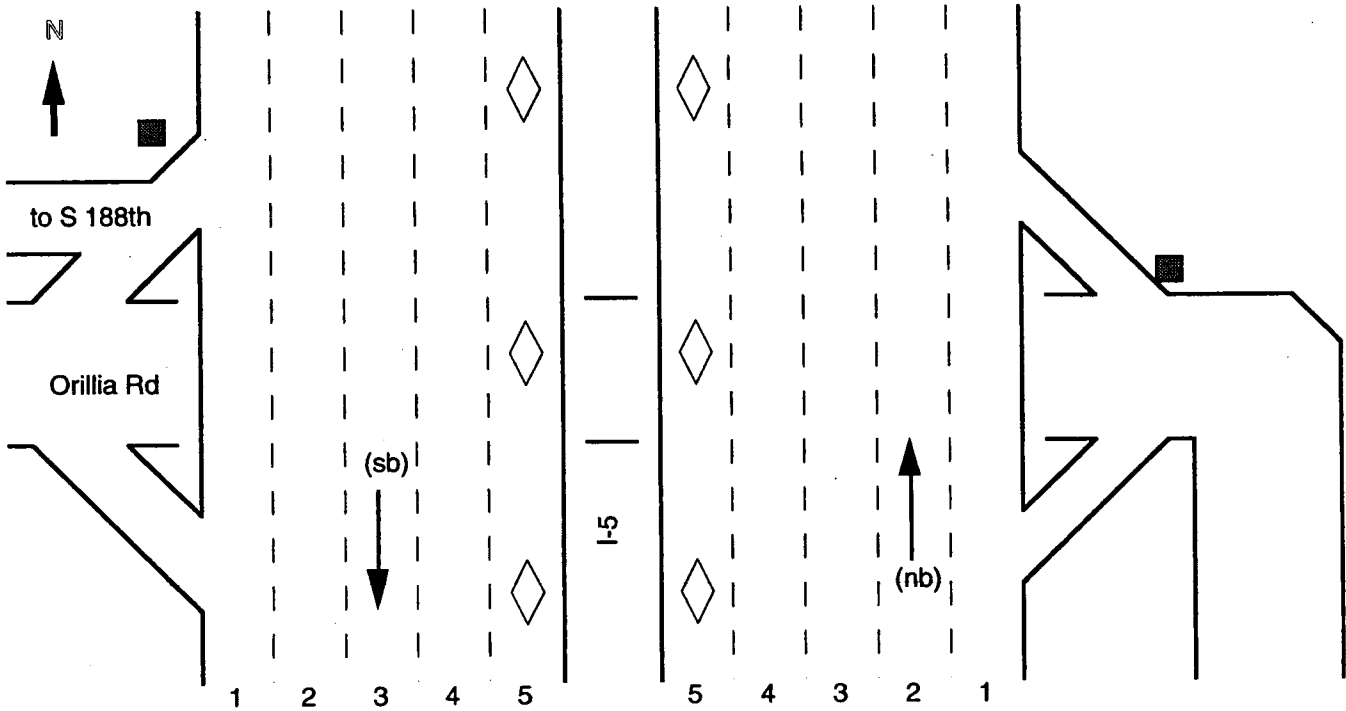

**Note:** Since both these ramps are very busy, and there is not a lot of clearance at the edges of the ramps, it is important that you have a vest and hard hat with you and make sure that you sit where drivers may be able to see you when sitting at the edge of the ramp.

**a.m. northbound**

	Qtr.	1	2	3	4+	Van	Public Transit	Other Bus	2 Axle	3+ Axle	Motor - cycle	TOTAL OBS.	ACO	Counts
On ramp	Q3/92	4582	656	86	30	4	1	7	303	422	13	6104	1.17	14
	Q4/92	1274	190	9	11	0	1	5	106	128	3	1727	1.16	6
	Q1/93	2905	357	24	8	2	2	11	238	200	2	3749	1.13	9
	Q2/93	971	125	9	2	0	1	4	75	76	1	1264	1.13	3
	Q3/93	4581	581	92	64	3	11	15	451	403	31	6232	1.18	10
	Q4/93	760	100	9	1	1	3	4	32	18	0	928	1.14	7
	Q1/94	2469	264	28	9	4	15	16	267	136	1	3209	1.13	9
	Q2/94	1054	149	14	12	1	4	1	90	101	4	1430	1.18	5
	Q3/94	1747	166	21	12	0	7	6	136	215	9	2319	1.13	15
	Q4/94	1038	120	6	5	2	2	2	106	142	0	1423	1.13	6
	Q1/95	1660	93	6	5	1	5	8	139	173	0	2090	1.07	7
	Q2/95	1921	184	10	9	1	11	8	141	210	16	2504	1.11	12
	Q3/95.	No observations											--	

**I-5 SOUTH - South 188th St./Orillia Road**

<b>p.m. southbound</b>															
	Qtr.	1	2	3	4+	Van	Public Transit	Other Bus	2 Axle	3+ Axle	Motor - cycle	TOTAL OBS.	ACO	Counts	
Off ramp	Q3/92	1390	351	50	36	4	8	1	79	122	6	2047	1.31	9	
	Q4/92	901	201	11	4	1	6	2	73	86	5	1290	1.21	4	
	Q1/93	1871	362	30	21	0	8	2	115	154	4	2567	1.21	9	
	Q2/93	1593	378	53	49	4	4	0	30	32	7	2150	1.31	5	
	Q3/93	1183	240	61	28	0	0	1	50	61	4	1628	1.30	5	
	Q4/93	1550	363	50	21	12	7	2	60	70	3	2138	1.27	10	
	Q1/94	1984	382	42	27	6	12	2	150	120	5	2730	1.23	8	
	Q2/94	No observations											--		
	Q3/94	993	166	34	10	2	5	1	82	106	2	1401	1.22	5	
	Q4/94	1859	310	36	10	10	10	1	186	110	3	2535	1.19	8	
	Q1/95	2567	442	49	22	11	8	4	113	95	3	3314	1.20	11	
	Q2/95	1131	182	22	8	4	7	0	161	58	0	1513	1.19	5	
	Q3/95	No observations											--		

**SITE #33. I-5 SOUTH - South 200th Street**

- ACO on/ramp NB-am
- ACO off/ramp SB-pm

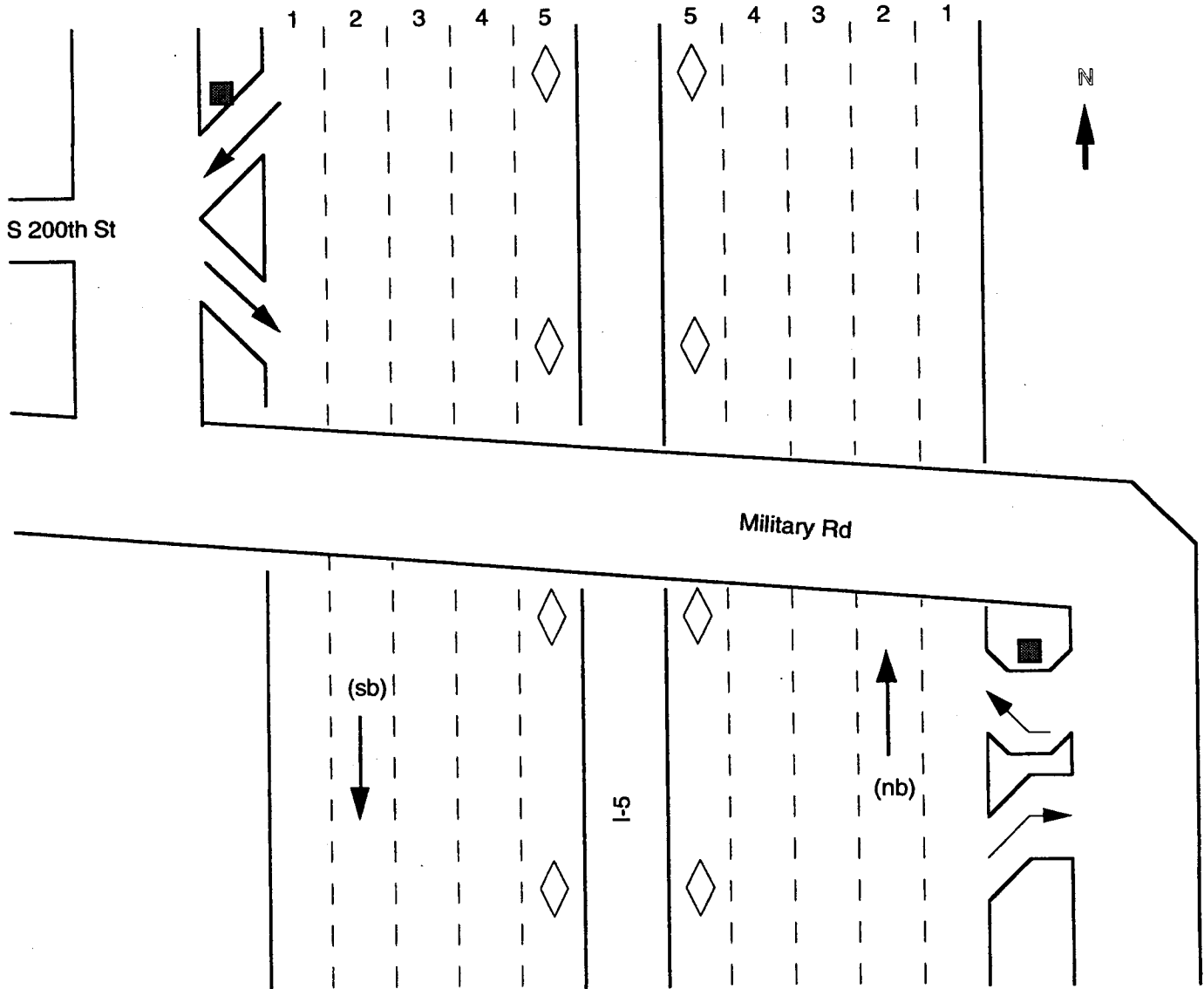

**I-5 South - South 200th Street**

**a.m. northbound**

	Qtr.	1	2	3	4+	Van	Public Transit	Other Bus	2 Axle	3+ Axle	Motor - cycle	TOTAL OBS.	ACO	Counts
On ramp	Q3/92	3620	435	56	27	5	0	2	35	18	9	4207	1.15	18
	Q4/92	1508	163	10	3	0	0	0	24	5	0	1713	1.11	6
	Q1/93	1149	130	5	10	1	0	0	15	12	9	1318	1.12	7
	Q2/93	562	15	1	0	0	0	0	9	6	3	596	1.03	4
	Q3/93	563	58	8	9	0	1	0	8	13	12	672	1.16	4
	Q4/93	243	35	4	1	0	0	2	13	3	0	301	1.16	1
	Q1/94	1161	140	17	6	0	0	1	16	5	3	1349	1.15	8
	Q2/94	784	99	10	1	0	0	3	22	11	2	932	1.14	5
	Q3/94	1396	158	15	10	0	0	2	35	13	9	1638	1.14	10
	Q4/94	645	95	11	4	1	0	0	16	11	2	785	1.17	6
	Q1/95	836	85	6	8	0	0	1	8	18	0	962	1.13	7
	Q2/95	954	123	14	2	4	0	1	18	14	5	1135	1.14	6
	Q3/95	No observations											--	

82

**p.m. southbound**

	Qtr.	1	2	3	4+	Van	Public Transit	Other Bus	2 Axle	3+ Axle	Motor - cycle	TOTAL OBS.	ACO	Counts
Off ramp	Q3/92	2122	408	73	29	1	1	5	25	18	22	2704	1.25	15
	Q4/92	1389	288	43	16	0	0	0	30	12	11	1789	1.24	13
	Q1/93	1386	294	36	15	3	7	0	265	19	3	2028	1.24	10
	Q2/93	480	82	24	4	0	0	0	254	8	3	855	1.24	6
	Q3/93	337	106	15	1	0	0	0	6	1	0	466	1.30	4
	Q4/93	1374	244	50	20	2	0	0	39	15	4	1748	1.24	10
	Q1/94	559	126	17	5	0	0	1	10	3	0	721	1.25	4
	Q2/94	1249	153	15	5	2	0	4	25	13	3	1469	1.14	9
	Q3/94	1121	258	49	25	5	0	2	21	9	5	1495	1.30	11
	Q4/94	1071	193	17	11	2	0	2	20	4	1	1321	1.20	9
	Q1/95	1398	177	10	13	3	2	0	23	14	2	1642	1.15	11
	Q2/95	1699	234	34	46	5	2	1	26	14	5	2066	1.22	9
	Q3/95	No observations											--	

111

**SITE #34. I-5 SOUTH - S 216th St.**

**▲ ACO mainline NB-am & SB-pm**

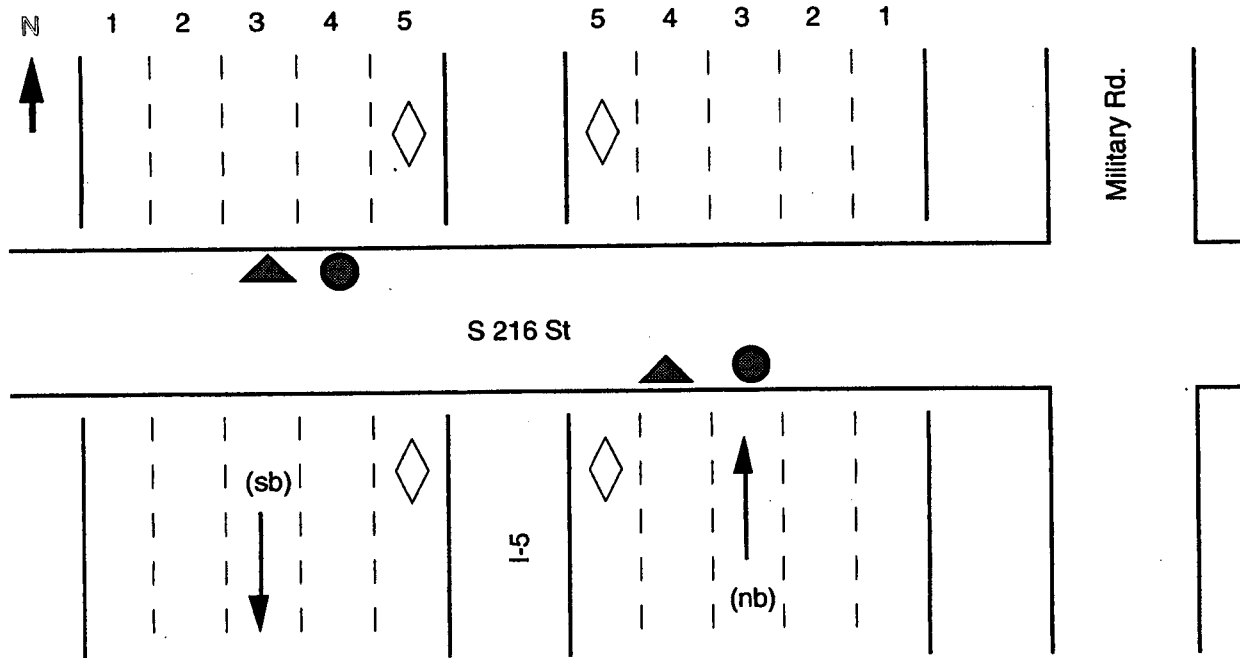

**Note: The NB HOV lane was changed from 3+ to 2+ effective December 21, 1992. The SB HOV lane was similarly changed effective December 7, 1992.**

**a.m. northbound**

HOV lanes	Qtr.	1	2	3	4+	Van	Public Transit	Other Bus	2 Axle	3+ Axle	Motor - cycle	TOTAL OBS.	ACO	Counts
1	Q3/92	7	24	25	14	2	2	1	0	0	7	82	2.70	2
	Q4/92	No observations											--	
	Q1/93	2	24	6	5	0	0	0	0	0	1	38	2.41	1
	Q2/93	5	159	33	19	3	7	0	2	0	10	238	2.32	2
	Q3/93	20	523	80	38	3	27	3	2	0	29	725	2.22	3
	Q4/93	17	264	54	27	5	10	1	1	0	1	380	2.27	3
	Q1/94	15	33	6	4	1	0	1	0	0	0	60	2.00	1
	Q2/94	5	85	6	8	2	3	2	0	0	0	113	2.18	1
	Q3/94	7	90	24	11	2	3	1	0	0	5	143	2.13	2
	Q4/94	33	700	47	12	2	26	1	16	0	4	841	2.05	4
	Q1/95	19	744	56	15	11	36	2	5	1	2	891	2.08	7
	Q2/95	28	2162	91	23	50	137	6	12	0	46	2555	2.05	17
	Q3/95	49	907	51	21	11	74	2	10	0	41	1166	2.05	8
	No observations conducted Q4/95 - Q2/96												--	
	Q3/96	87	3610	189	43	78	200	8	5	1	123	4344	2.05	13
	No observations conducted Q4/96 - Q1/97												--	
	Q2/97	75	3332	141	34	95	156	7	8	0	79	3927	2.04	9
	Q3/97	73	5295	195	36	134	231	9	5	0	140	6118	2.04	14
	No observations conducted Q4/97 - Q1/98												--	
	Q2/98	87	59229	555	104	109	236	33	141	0	57	7251	2.10	16

**I-5 South - 216th St**

**a.m. northbound**

	Qtr.	1	2	3	4+	Van	Public Transit	Other Bus	2 Axl e	3+ Axle	Motor - cycle	TOTAL OBS.	ACO	Counts
GP lanes 4	Q3/92	6040	883	72	29	3	11	4	80	200	8	7330	1.16	11
	Q4/92	5521	547	48	9	0	8	2	104	244	7	6190	1.12	8
	Q1/93	4929	360	21	14	3	7	4	103	171	1	5613	1.08	7
	Q2/93	6981	562	60	20	0	10	2	132	235	1	8003	1.10	12
	Q3/93	8411	936	168	57	3	21	10	238	353	27	10224	1.15	14
	Q4/93	5890	262	28	27	2	9	6	109	294	4	6631	1.07	14
	Q1/94	6525	378	37	12	1	14	4	148	329	3	7451	1.07	13
	Q2/94	5778	533	40	19	2	16	6	139	376	9	6918	1.11	10
	Q3/94	5060	618	52	44	2	25	6	124	245	25	6201	1.15	13
	Q4/94	1563	97	6	4	3	1	0	35	113	0	1822	1.07	3
	Q1/95	3776	215	11	6	7	4	5	59	240	2	4325	1.06	8
	Q2/95	5575	386	34	14	8	6	4	83	245	5	6360	1.08	10
	Q3/95	2600	152	16	8	2	2	1	61	102	4	2948	1.08	7
	No observations conducted Q4/95 - Q2/96												--	
	Q3/96	6152	452	52	27	5	10	3	109	391	4	7205	1.10	10
	No observations conducted Q4/96 - Q1/97												--	
	Q2/97	5244	302	40	11	6	3	2	83	336	8	6035	1.07	8
	Q3/97	6967	452	64	29	14	10	1	120	508	9	8174	1.07	12
	No observations conducted Q4/97 - Q1/98												--	
	Q2/98	8251	531	42	17	1	6	12	265	451	4	9580	1.08	12

172

**p.m. southbound**

	Qtr.	1	2	3	4+	Van	Public Transit	Other Bus	2 Axle	3+ Axle	Motor - cycle	TOTAL OBS.	ACO	Counts
HOV lanes 1	Q3/92	4	11	112	63	3	11	4	0	0	26	271	2.92	1
	Q4/92	7	46	43	8	9	4	0	2	0	3	122	2.52	1
	Q1/93	36	642	68	28	12	35	4	2	0	5	832	2.12	3
	Q2/93	16	802	168	61	14	31	5	15	0	8	1120	2.27	2
	Q3/93	57	982	212	92	11	33	6	18	1	20	1432	2.27	3
	Q4/93	36	898	83	43	7	31	3	9	0	22	1132	2.13	3
	Q1/94	49	1152	210	59	19	36	8	6	0	9	1548	2.20	1
	Q2/94	18	911	85	56	15	28	2	5	0	12	1132	2.18	3
	Q3/94	37	1972	229	90	42	63	2	15	0	51	2501	2.17	4
	Q4/94	86	3212	209	43	134	38	2	18	0	16	3758	2.06	6
	Q1/95	100	3409	158	21	156	106	11	8	1	16	3986	2.03	9
	Q2/95	86	4422	465	109	139	95	10	34	3	116	5479	2.12	10
	Q3/95	93	4035	209	44	133	91	11	12	0	98	4726	2.05	8
	No observations conducted Q4/95 - Q2/96												--	
	Q3/96	95	4872	465	169	148	157	9	19	1	151	6086	2.13	11
	No observations conducted Q4/96 - Q1/97												--	
	Q2/97	126	3295	541	134	93	70	14	13	0	57	4343	2.17	7
	Q3/97	131	4218	633	288	116	130	14	26	1	121	5678	2.22	11
	No observations conducted Q4/97 - Q1/98												--	
	Q2/98	190	4904	948	247	220	160	45	201	1	74	6990	2.21	15

98

**I-5 South - 216th St**

**p.m. southbound**

	Qtr.	1	2	3	4+	Van	Public Transit	Other Bus	2 Axle	3+ Axle	Motor - cycle	TOTAL OBS.	ACO	Counts
GP lanes 4	Q3/92	6558	1215	188	68	8	17	7	102	197	27	8387	1.23	13
	Q4/92	3420	451	21	7	0	8	8	67	168	0	4150	1.13	7
	Q1/93	10469	1294	95	30	4	15	9	368	344	12	12640	1.13	14
	Q2/93	14311	2047	83	4	6	26	6	225	442	14	17164	1.14	20
	Q3/93	10551	1162	162	57	6	21	7	220	325	27	12538	1.14	16
	Q4/93	8806	1078	106	110	12	12	6	217	355	5	10707	1.16	12
	Q1/94	7767	974	148	47	14	16	7	172	246	6	9397	1.16	7
	Q2/94	6027	702	97	42	15	12	4	127	190	7	7223	1.15	13
	Q3/94	10627	1172	155	85	15	25	3	190	408	27	12707	1.15	18
	Q4/94	2623	336	31	13	11	10	0	72	128	0	3224	1.15	4
	Q1/95	6967	457	49	35	6	15	8	100	250	5	7892	1.09	10
	Q2/95	6512	527	71	58	5	14	4	103	177	9	7480	1.12	11
	Q3/95	4278	307	63	15	12	9	2	75	222	3	4986	1.10	8
	No observations conducted Q4/95 - Q2/96												--	
	Q3/96	5450	646	95	56	8	26	1	93	293	7	6675	1.16	11
	No observations conducted Q4/96 - Q1/97												--	
	Q2/97	3685	298	35	14	10	1	0	46	91	1	4181	1.10	6
	Q3/97	9340	755	137	66	62	26	19	187	307	12	10911	1.12	15
	No observations conducted Q4/97 - Q1/98													
	Q2/98	6803	559	64	13	11	19	7	186	290	6	7958	1.10	13

198

**SITES #35,36,37. I-5 SOUTH - SR 516: Kent/Des Moines Road**

■ ACO on/ramp NB from Kent-am & from DesMoines-am

■ ACO off/ramp SB-pm

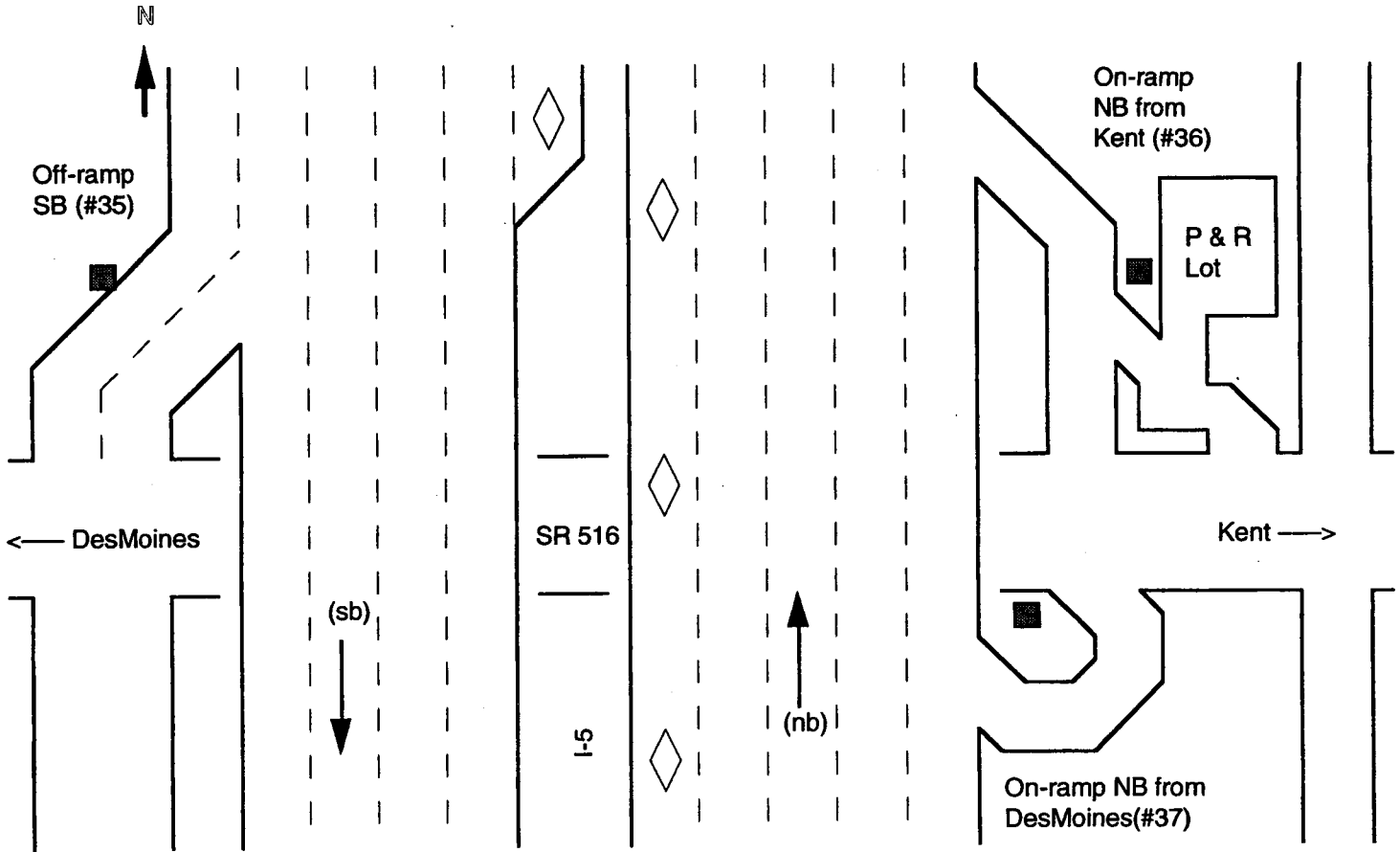

**p.m. southbound**

	Qtr.	1	2	3	4+	Van	Public Transit	Other Bus	2 Axle	3+ Axle	Motor -cycle	TOTAL OBS.	ACO	Counts
Off ramp	Q3/92	7681	1429	273	62	17	101	11	161	73	72	9880	1.23	20
	Q4/92	3400	476	70	28	14	34	14	93	50	6	4185	1.16	7
	Q1/93	5364	838	91	46	16	58	3	67	50	8	6541	1.18	11
	Q2/93	2414	419	57	15	7	22	5	49	26	13	3027	1.20	5
	Q3/93	2308	444	111	46	5	25	1	67	33	45	3085	1.28	5
	Q4/93	3906	517	30	47	13	44	3	64	15	3	4642	1.16	9
	Q1/94	4546	870	170	52	22	53	6	59	56	9	5843	1.24	11
	Q2/94	5072	885	107	51	26	66	5	97	71	19	6399	1.21	12
	Q3/94	2689	555	108	49	16	27	1	56	32	32	3565	1.27	5
	Q4/94	5670	874	92	20	29	61	4	86	67	10	6913	1.17	13
	Q1/95	6346	786	101	29	29	67	12	79	68	25	7542	1.15	12
	Q2/95	4279	405	29	61	15	40	1	60	28	15	4933	1.14	10
	Q3/95	No observations											--	



### I-5 South - SR516: Kent/Des Moines Road

#### a.m. northbound, Kent

	Qtr.	1	2	3	4+	Van	Public Transit	Other Bus	2 Axle	3+ Axle	Motor - cycle	TOTAL OBS.	ACO	Counts
On ramp	Q3/92	4739	580	80	28	9	77	5	122	90	26	5756	1.15	15
	Q4/92	1099	106	8	2	5	18	0	23	18	1	1280	1.11	3
	Q1/93	6917	666	64	19	17	118	8	111	133	7	8060	1.11	19
	Q2/93	934	117	11	6	3	20	0	32	22	4	1149	1.15	3
	Q3/93	1190	187	21	3	2	20	0	35	24	8	1490	1.17	4
	Q4/93	435	52	6	4	0	9	2	23	15	0	546	1.15	2
	Q1/94	814	104	10	2	0	16	3	33	8	1	991	1.14	4
	Q2/94	2160	254	28	10	5	52	3	68	61	8	2649	1.14	9
	Q3/94	840	122	16	7	4	30	2	18	28	7	1074	1.18	5
	Q4/94	807	69	5	5	1	22	3	36	37	3	988	1.11	4
	Q1/95	1674	125	20	4	2	31	4	48	62	0	1970	1.10	9
	Q2/95	2859	244	32	6	7	61	1	51	57	9	3327	1.10	10
	Q3/95	No observations											--	

87

#### a.m. northbound, Des Moines

	Qtr.	1	2	3	4+	Van	Public Transit	Other Bus	2 Axle	3+ Axle	Motor - cycle	TOTAL OBS.	ACO	Counts
On ramp	Q3/92	2778	332	36	17	2	18	3	59	50	10	3305	1.14	16
	Q4/92	800	88	12	1	0	5	1	18	10	2	937	1.13	3
	Q1/93	1770	162	12	1	0	12	1	18	26	2	2011	1.10	10
	Q2/93	No observations											--	
	Q3/93	604	51	1	7	0	8	0	12	7	3	693	1.11	4
	Q4/93	385	53	2	1	0	2	1	8	6	0	458	1.14	3
	Q1/94	815	41	5	1	0	6	0	6	6	0	880	1.06	5
	Q2/94	1470	197	33	8	0	12	1	15	14	14	1764	1.17	9
	Q3/94	279	40	5	3	0	6	0	7	5	4	349	1.18	5
	Q4/94	1092	134	11	6	0	7	1	18	24	1	1294	1.14	10
	Q1/95	1000	52	9	2	1	5	1	18	9	2	1099	1.07	8
	Q2/95	1218	129	6	6	0	7	2	20	14	2	1404	1.07	9
	Q3/95	No observations											--	

82

**SITE #39. I-5 SOUTH - South 272nd Street**

- ACO on/ramp NB-am
- ACO off/ramp SB-pm

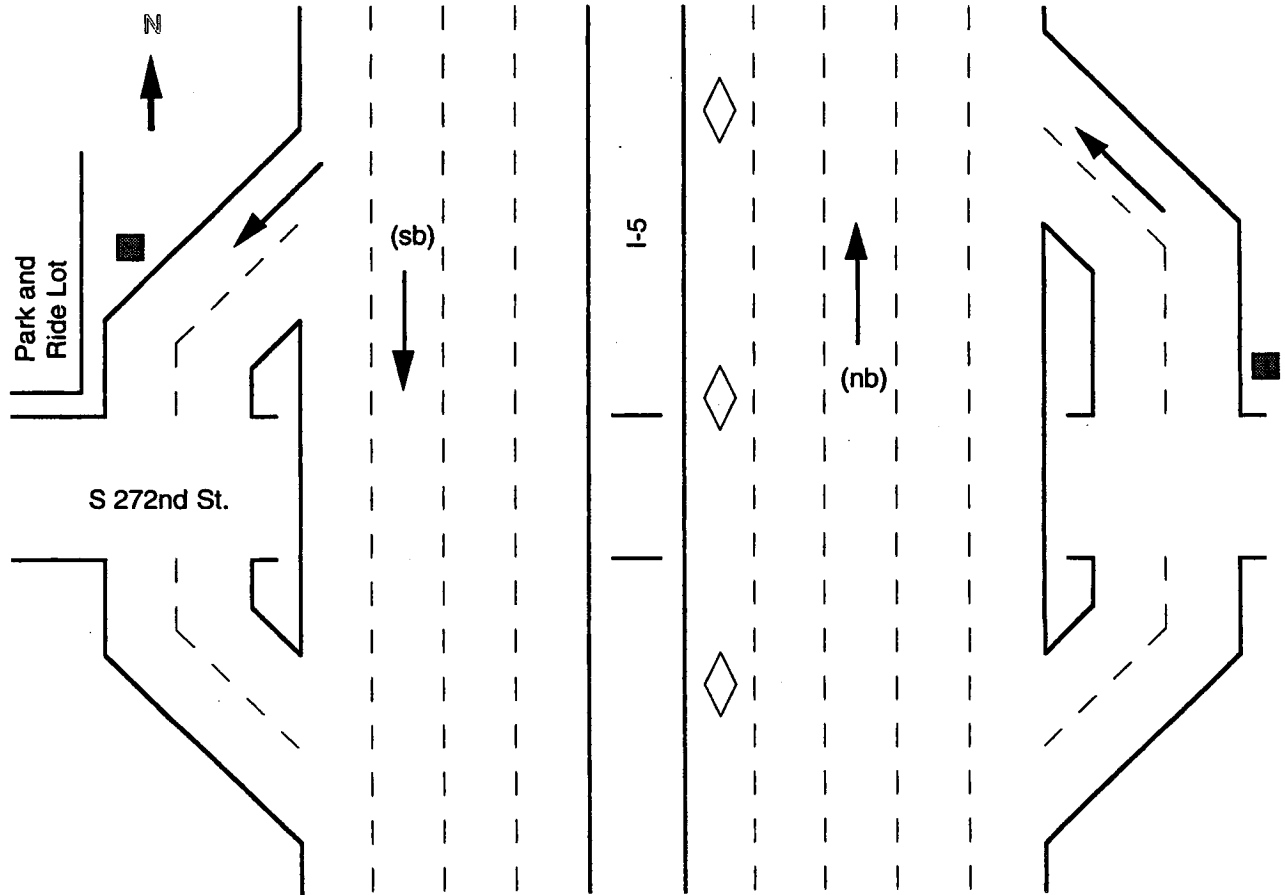

**a.m. northbound**

	Qtr.	1	2	3	4+	Van	Public Transit	Other Bus	2 Axle	3+ Axle	Motor - cycle	TOTAL OBS.	ACO	Counts
On ramp	Q3/92	11866	1324	189	87	30	124	5	187	69	99	13980	1.15	27
	Q4/92	4902	452	46	21	8	61	5	69	37	8	5609	1.11	13
	Q1/93	6177	689	57	16	15	80	7	74	27	3	7145	1.12	13
	Q2/93	2071	141	22	9	5	18	1	32	11	6	2316	1.10	4
	Q3/93	5689	462	49	41	5	60	5	108	48	41	6508	1.11	14
	Q4/93	1251	39	10	3	1	22	0	27	11	3	1367	1.05	4
	Q1/94	No observations											--	
	Q2/94	3658	533	63	19	6	39	5	71	30	27	4451	1.17	8
	Q3/94	1270	140	12	7	3	26	0	26	21	3	1508	1.13	5
	Q4/94	2740	272	20	14	0	26	4	59	40	6	3181	1.12	8
	Q1/95	920	40	5	0	0	9	3	17	13	0	1007	1.05	2
	Q2/95	5303	244	18	23	13	39	1	52	25	20	5738	1.06	9
	Q3/95	No observations											--	

**I-5 SOUTH - South 272nd Street**

p.m.	southbound												TOTAL OBS.	ACO	Counts
	Qtr.	1	2	3	4+	Van	Public Transit	Other Bus	2 Axle	3+ Axle	Motor - cycle				
Off ramp	Q3/92	6903	1226	279	115	45	66	3	115	28	51	8831	1.25	15	
	Q4/92	3133	397	59	25	14	21	1	50	18	7	3725	1.16	7	
	Q1/93	1541	214	32	9	4	16	0	25	8	1	1850	1.17	3	
	Q2/93	2196	437	72	43	13	21	0	29	21	7	2839	1.26	5	
	Q3/93	3548	684	87	66	21	28	1	78	20	38	4571	1.24	11	
	Q4/93	No observations											--		
	Q1/94	1875	301	43	17	15	17	0	39	17	3	2327	1.20	4	
	Q2/94	4360	853	83	44	28	37	3	125	32	25	5590	1.22	9	
	Q3/94	4800	805	130	87	38	39	2	103	47	35	6086	1.23	10	
	Q4/94	2562	308	41	7	21	25	1	20	21	7	3013	1.14	6	
	Q1/95	3678	455	38	28	39	27	3	42	18	2	4330	1.15	10	
	Q2/95	4512	406	27	69	26	29	0	79	24	11	5183	1.14	10	
	Q3/95	No observations											--		

90

# Vehicle Occupancy (ACO) Sites SR 520 (Corridor #4)

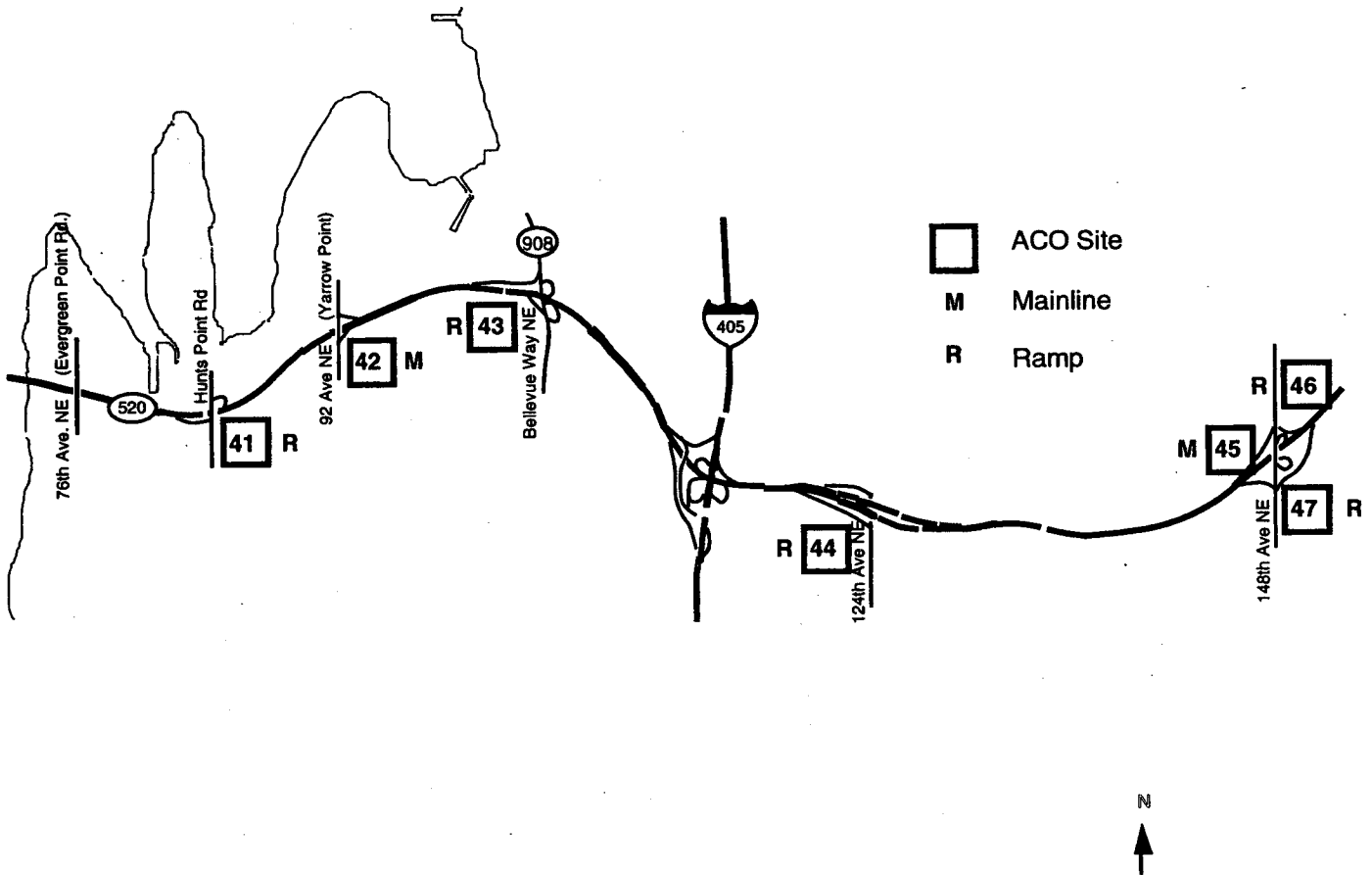

**SITE #41. SR 520 - Hunt's Point**

■ ACO on/ramp WB-am

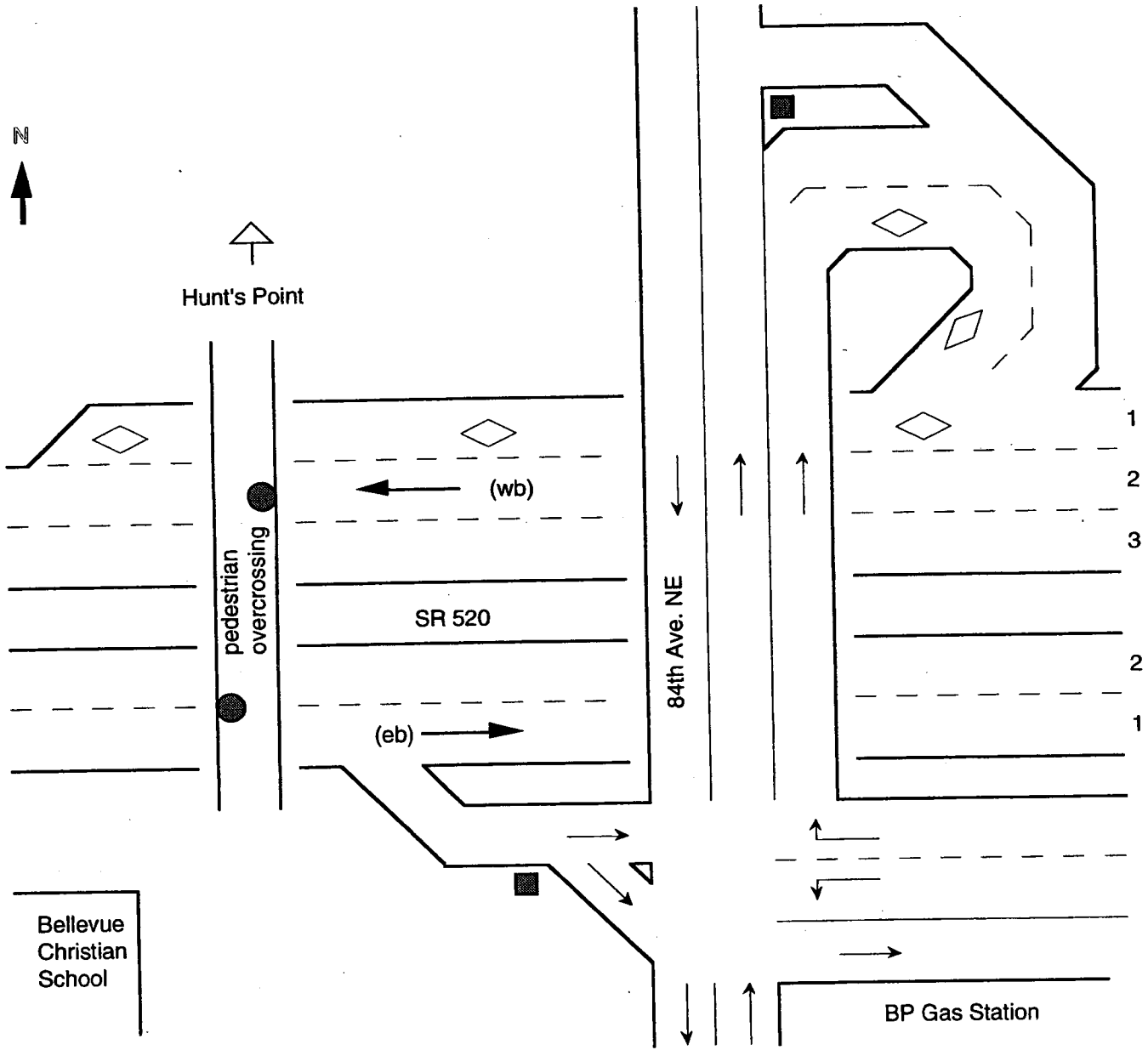

**Note:** There is an HOV lane on the outside, but only going westbound. There is currently no HOV lane going eastbound at this location.

**SR 520 - Hunt's Point**

**a.m. westbound**

	Qtr.	1	2	3	4+	Van	Public Transit	Other Bus	2 Axle	3+ Axle	Motor- cycle	TOTAL OBS.	ACO	Counts	
On ramp	Q3/92	2917	355	33	23	1	32	3	25	2	5	3396	1.15	15	
	Q4/92	No observations											-		
	Q1/93	922	69	3	1	0	8	0	7	1	0	1011	1.08	4	
	Q2/93	No observations											-		
	Q3/93	1720	176	35	19	0	21	2	25	2	1	2001	1.16	10	
	Q4/93	917	127	13	7	0	7	0	1	0	0	1072	1.16	3	
	Q1/94	957	116	17	5	0	7	1	8	1	0	1112	1.15	4	
	Q2/94	874	99	9	1	0	10	1	5	0	1	1000	1.12	5	
	Q3/94	650	96	10	2	0	9	0	5	1	0	773	1.16	5	
	Q4/94	1575	127	9	3	0	17	0	9	0	0	1740	1.09	8	
	Q1/95	1948	192	17	11	3	20	0	16	1	0	2208	1.12	11	
	Q2/95	888	71	7	2	0	12	0	9	2	3	994	1.09	9	
	Q3/95	No observations											-		

74

**p.m. eastbound**

	Qtr.	1	2	3	4+	Van	Public Transit	Other Bus	2 Axle	3+ Axle	Motor- cycle	TOTAL OBS.	ACO	Counts
Off ramp	Q1/94	900	211	31	12	0	13	0	10	0	2	1179	1.27	6
	Q2/94	809	165	28	13	0	12	1	8	0	3	1039	1.26	5
	Q3/94	1595	331	60	37	5	25	0	7	1	7	2068	1.28	13
	Q4/94	1365	188	17	14	0	16	0	9	0	2	1611	1.17	10
	Q1/95	910	140	19	4	2	13	0	3	0	0	1091	1.18	6
	Q2/95	731	122	20	9	0	10	4	5	0	3	904	1.22	5
	Q3/95	No observations											-	

45

**SITE #42. SR 520 - Yarrow Point**

▲ ACO mainline WB-am & EB-pm

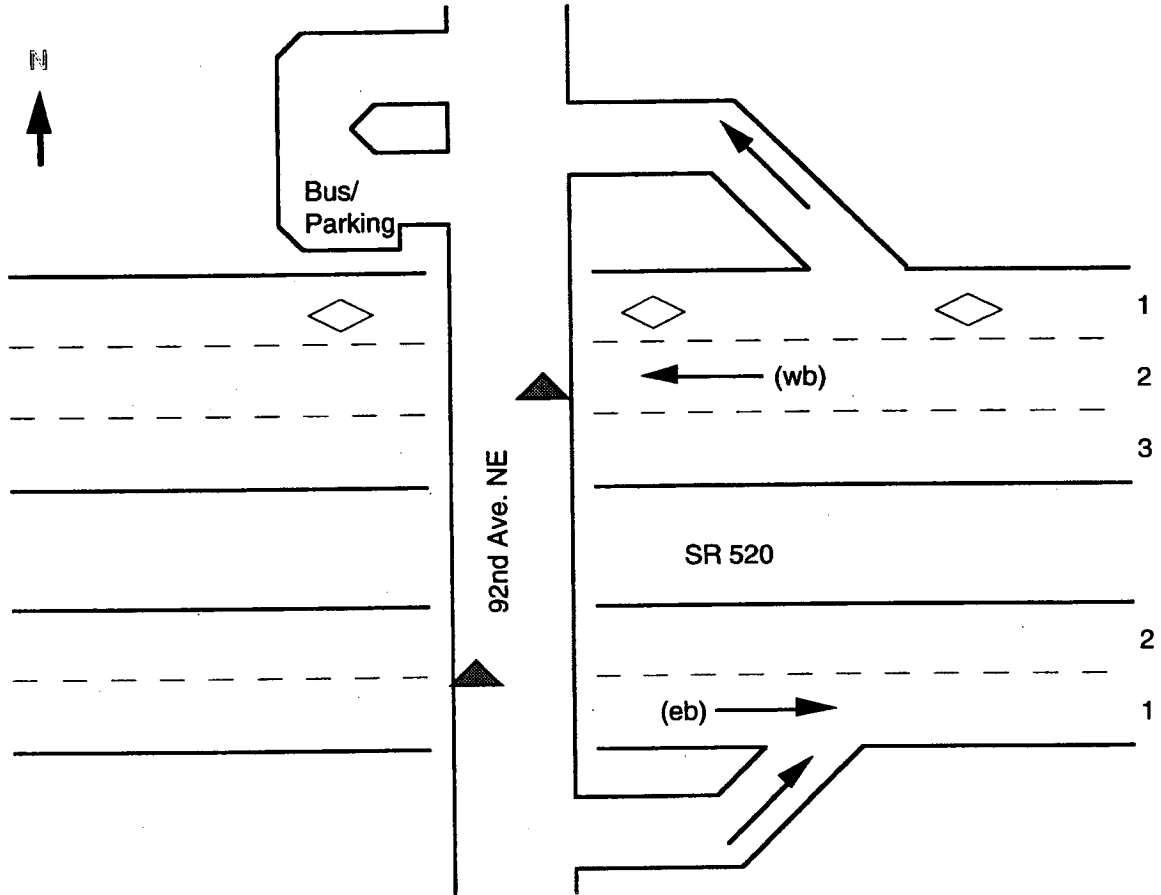

**Note:** There is an HOV lane on the outside of the westbound mainline lanes in this location. Be sure to count it as lane #1.

**SR 520 - Yarrow Point**

**a.m. westbound**

	Qtr.	1	2	3	4+	Van	Public Transit	Other Bus	2 Axle	3+ Axle	Motor- cycle	TOTAL OBS.	ACO	Counts
HOV	Q3/92	5	6	26	3	1	20	1	0	0	10	72	2.69	2
lanes	Q4/92	23	9	1	0	0	24	0	0	0	4	61	1.33	1
1	Q1/93	3	12	34	8	2	36	1	0	0	6	102	2.85	2
	Q2/93	5	14	79	29	5	94	2	0	0	20	248	3.09	4
	Q3/93	18	52	62	25	6	116	2	0	0	32	313	2.63	7
	Q4/93	9	18	38	5	0	30	4	1	0	4	109	2.57	5
	Q1/94	6	25	43	5	1	31	1	0	0	0	112	2.61	3
	Q2/94	2	2	15	4	2	44	1	0	0	7	77	2.95	2
	Q3/94	14	29	106	23	4	128	2	2	1	34	343	2.83	8
	Q4/94	12	159	51	4	8	101	2	1	0	9	347	2.21	5
	Q1/95	30	127	187	33	7	199	3	1	0	24	611	2.61	12
	Q2/95	40	141	151	5	11	210	7	1	0	59	625	2.36	10
	Q3/95	8	8	90	21	1	90	0	0	2	26	246	3.01	8
	No observations conducted Q4/95 - Q2/96												-	
	Q3/96	26	72	131	29	6	138	3	0	0	40	445	2.65	9
	No observations conducted Q4/96 - Q1/97												-	
	Q2/97	41	66	206	18	18	187	4	1	0	18	559	2.62	12
	Q3/97	40	72	216	21	18	198	10	2	0	35	612	2.64	11
	No observations conducted Q4/97 - Q1/98												-	
	Q2/98	154	204	157	63	25	226	10	40	3	40	922	2.24	13



**SR 520 - Yarrow Point**

**a.m. westbound**

		Qtr.	1	2	3	4+	Van	Public Transit	Other Bus	2 Axle	3+ Axle	Motor- cycle	TOTAL OBS.	ACO	Counts	
GP lanes 2	Q3/92	3170	394	10	3	0	8	1	57	26	2	<b>3671</b>	<b>1.12</b>		6	
	Q4/92	1082	86	0	0	0	0	0	22	6	0	<b>1196</b>	<b>1.07</b>		2	
	Q1/93	2964	340	6	0	0	0	0	42	18	0	<b>3370</b>	<b>1.11</b>		4	
	Q2/93	7004	823	29	5	3	13	3	145	78	3	<b>8106</b>	<b>1.11</b>		12	
	Q3/93	10737	1260	68	24	1	18	7	240	161	13	<b>12529</b>	<b>1.12</b>		17	
	Q4/93	3507	276	11	3	0	2	0	60	34	3	<b>3896</b>	<b>1.08</b>		9	
	Q1/94	5260	531	9	2	0	10	4	105	55	0	<b>5976</b>	<b>1.10</b>		11	
	Q2/94	4849	466	20	13	0	4	0	104	47	3	<b>5506</b>	<b>1.10</b>		7	
	Q3/94	6277	653	22	4	2	11	3	137	61	26	<b>7196</b>	<b>1.10</b>		12	
	Q4/94	3548	395	7	0	0	0	0	120	23	0	<b>4093</b>	<b>1.10</b>		7	
	Q1/95	4297	536	4	2	1	2	0	106	70	0	<b>5018</b>	<b>1.11</b>		8	
	Q2/95	4835	510	16	4	0	8	2	117	45	4	<b>5541</b>	<b>1.10</b>		9	
	Q3/95	1858	136	2	5	0	0	1	45	19	0	<b>2066</b>	<b>1.08</b>		6	
	No observations conducted Q4/95 - Q2/96													-		
	Q3/96	4172	424	13	3	0	3	0	87	51	5	<b>4758</b>	<b>1.10</b>		8	
	No observations conducted Q4/96 - Q1/97													-		
	Q2/97	4226	307	7	19	1	8	1	70	49	1	<b>4689</b>	<b>1.08</b>		11	
	Q3/97	5094	323	8	2	0	6	0	84	43	2	<b>5562</b>	<b>1.06</b>		8	
	No observations conducted Q4/97 - Q1/98													-		
	Q2/98	10003	1045	38	16	7	10	5	297	78	11	<b>11510</b>	<b>1.11</b>		17	
<b>154</b>																

**p.m. westbound**

		Qtr.	1	2	3	4+	Van	Public Transit	Other Bus	2 Axle	3+ Axle	Motor- cycle	TOTAL OBS.	ACO	Counts	
HOV lanes 1	Q2/97	47	311	375	82	5	69	5	7	0	62	<b>963</b>	<b>2.62</b>		6	
	Q3/97	9	53	150	92	44	45	3	6	2	21	<b>425</b>	<b>3.13</b>		6	
	No observations conducted Q4/97 - Q1/98													-		
	Q2/98	128	343	762	174	71	163	18	21	1	130	<b>1811</b>	<b>2.72</b>		17	
<b>29</b>																

**p.m. westbound**

		Qtr.	1	2	3	4+	Van	Public Transit	Other Bus	2 Axle	3+ Axle	Motor- cycle	TOTAL OBS.	ACO	Counts
GP lanes 2	Q2/97	2291	359	5	6	2	0	0	21	8	0	<b>2692</b>	<b>1.15</b>		4
	Q3/97	1191	206	9	4	3	3	1	9	5	1	<b>1432</b>	<b>1.17</b>		4
	No observations conducted Q4/97 - Q1/98													-	
Q2/98	7990	1022	25	4	3	11	1	103	19	7	<b>9185</b>	<b>1.12</b>		15	
<b>23</b>															

**SR 520 - Yarrow Point**

**a.m. eastbound**

	Qtr.	1	2	3	4+	Van	Public Transit	Other Bus	2 Axle	3+ Axle	Motor- cycle	TOTAL OBS.	ACO	Counts
GP lanes	Q2/97	10316	608	39	12	28	90	3	96	46	54	11292	1.07	16
	Q3/97	5412	364	25	5	14	56	2	47	36	39	6000	1.07	8
2	No observations conducted Q4/97 - Q1/98													
	Q2/98	20212	1646	129	33	85	209	11	359	135	154	22973	1.09	31
														55

**p.m. eastbound**

	Qtr.	1	2	3	4+	Van	Public Transit	Other Bus	2 Axle	3+ Axle	Motor- cycle	TOTAL OBS.	ACO	Counts
GP lanes	Q3/92	4480	879	99	32	2	49	0	46	16	28	5630	1.21	15
	Q4/92	4157	626	36	8	1	49	3	61	24	11	4976	1.15	6
2	Q1/93	1897	310	38	8	8	20	5	51	1	3	2341	1.18	6
	Q2/93	10760	1997	151	28	4	138	5	2245	53	63	15444	1.18	21
	Q3/93	15060	2778	282	115	3	200	1	284	67	86	18876	1.20	25
	Q4/93	14684	2745	299	115	20	207	6	290	88	55	18509	1.21	24
	Q1/94	8351	1751	216	67	5	100	4	121	37	24	10676	1.23	16
	Q2/94	12651	2448	275	142	13	175	2	186	61	42	15995	1.22	24
	Q3/94	11063	1611	176	122	1	195	7	158	56	74	13463	1.18	21
	Q4/94	9698	1318	152	78	8	117	0	148	40	25	11584	1.17	17
	Q1/95	7896	1344	121	43	3	82	3	108	37	12	9649	1.18	13
	Q2/95	9003	1516	140	52	19	124	2	123	60	47	11086	1.18	15
	Q3/95	9604	1782	322	75	46	119	10	131	53	42	12184	1.23	17
	No observations conducted Q4/95 - Q2/96													
	Q3/96	8444	1454	181	88	32	136	10	115	52	52	10564	1.21	17
	No observations conducted Q4/96 - Q1/97													
	Q2/97	6397	1473	165	46	18	87	0	75	23	38	8322	1.24	12
	Q3/97	11714	2667	314	159	38	224	1	151	64	53	15385	1.26	23
	No observations conducted Q4/97 - Q1/98													
	Q2/98	16813	3053	254	106	37	246	17	416	68	52	21052	1.19	27
														299

**SITE #43. SR 520 - SR 908: Bellevue/Kirkland**

- ACO on/ramp WB from Kirkland-am
- ACO off/ramp EB to Kirkland-pm

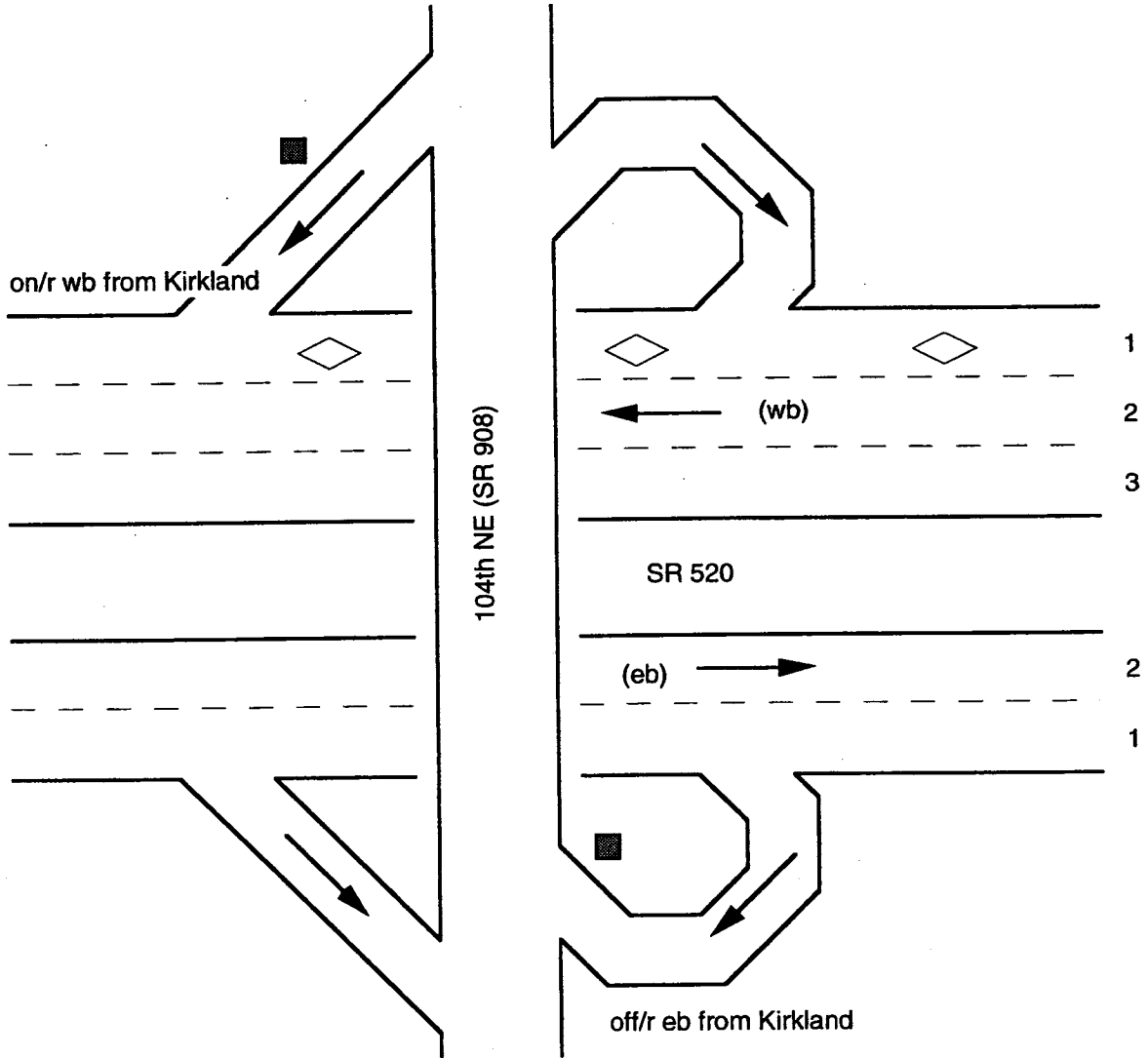

**SR 520 - SR 908: Bellevue/Kirkland**

**a.m. westbound**

	Qtr.	1	2	3	4+	Van	Public Transit	Other Bus	2 Axle	3+ Axle	Motor- cycle	TOTAL OBS.	ACO	Counts
On ramp	Q3/92	1776	212	20	9	3	7	0	11	3	7	2048	1.14	11
	Q4/92	1914	178	19	2	3	9	0	14	5	3	2147	1.11	8
	Q1/93	954	64	12	4	1	4	0	4	0	1	1044	1.10	4
	Q2/93	1784	140	12	5	0	6	0	16	4	6	1973	1.09	7
	Q3/93	2791	188	22	8	2	9	0	34	4	12	3070	1.09	10
	Q4/93	318	32	6	0	0	0	0	11	15	0	382	1.12	3
	Q1/94	744	66	7	4	0	4	0	7	1	1	834	1.11	3
	Q2/94	1004	106	15	8	1	5	0	7	1	10	1157	1.14	5
	Q3/94	2766	217	27	4	3	15	4	25	10	2	3073	1.09	5
	Q4/94	1096	63	7	7	2	4	0	10	2	4	1195	1.08	7
	Q1/95	1191	91	20	3	1	7	0	10	1	1	1325	1.11	7
	Q2/95	1108	87	14	8	2	7	3	8	2	5	1244	1.12	11
	Q3/95	No observations											--	

81

**p.m. eastbound**

	Qtr.	1	2	3	4+	Van	Public Transit	Other Bus	2 Axle	3+ Axle	Motor- cycle	TOTAL OBS.	ACO	Counts
Off ramp	Q3/92	940	228	33	16	2	14	1	5	2	7	1248	1.28	4
	Q4/92	2892	433	41	26	2	38	2	22	4	7	3467	1.18	15
	Q1/93	3481	612	76	54	4	70	0	458	6	12	4773	1.22	14
	Q2/93	1326	263	36	22	0	17	0	10	2	13	1689	1.25	6
	Q3/93	2345	499	101	40	5	42	0	18	2	22	3074	1.28	10
	Q4/93	1337	231	24	10	4	24	0	13	3	2	1648	1.19	5
	Q1/94	2455	514	69	24	2	45	0	24	2	11	3146	1.24	10
	Q2/94	1823	366	59	19	4	24	2	10	2	12	2323	1.24	10
	Q3/94	2341	458	93	49	10	46	1	19	4	16	3037	1.27	10
	Q4/94	1617	248	22	9	6	28	0	12	1	0	1943	1.17	6
	Q1/95	747	114	12	5	0	14	0	2	1	0	895	1.18	4
	Q2/95	901	136	15	8	2	22	0	1	0	7	1092	1.18	5
	Q3/95	No observations											--	

99

**SITE #44. SR 520 - 124th Avenue NE**

- ACO on/ramp WB-am
- ACO off/ramp EB-pm

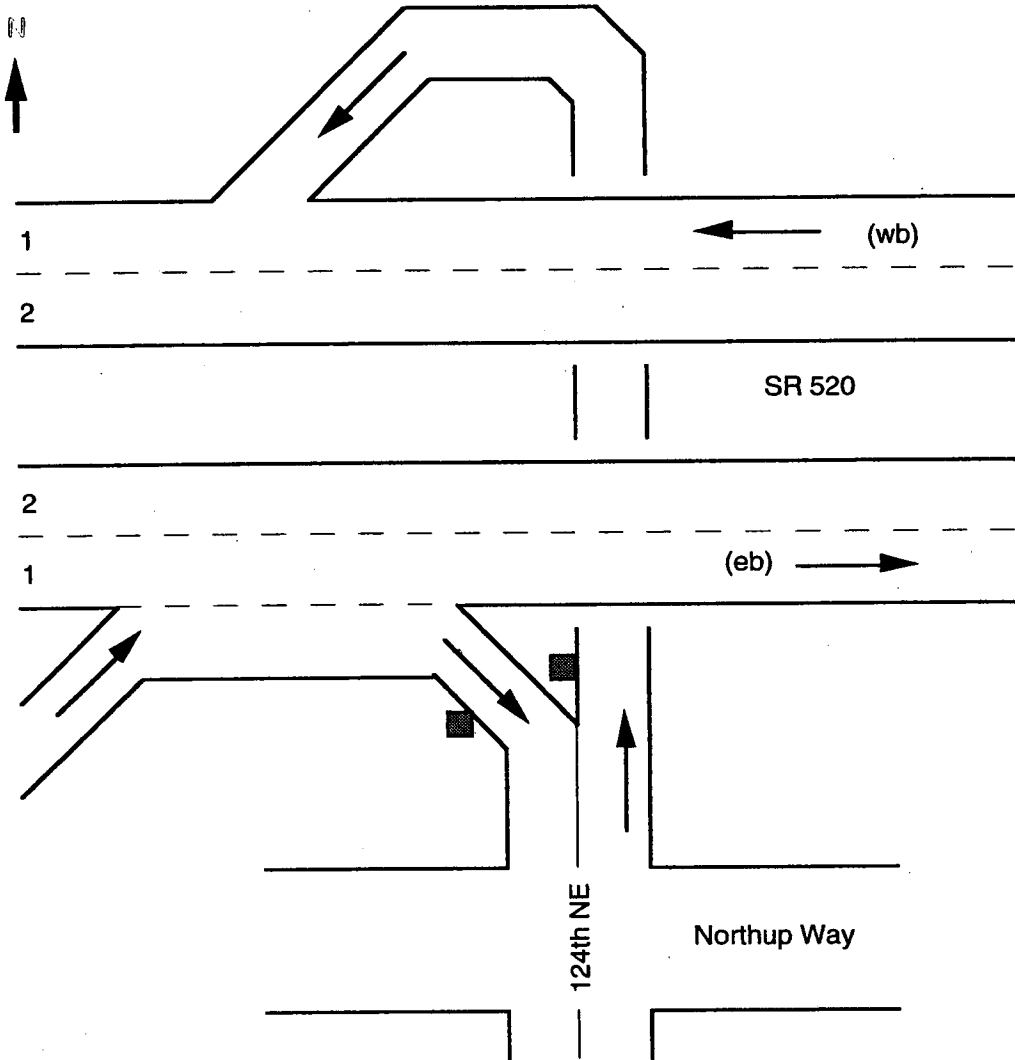

**SR 520 - 124th Avenue NE**

**a.m. westbound**

	Qtr.	1	2	3	4+	Van	Public Transit	Other Bus	2 Axle	3+ Axle	Motor- cycle	TOTAL OBS.	ACO	Counts
On ramp	Q3/92	2604	314	50	24	4	25	2	134	149	9	3315	1.16	15
	Q4/92	3225	265	29	13	3	30	4	271	242	2	4077	1.10	19
	Q1/93	No observations											--	
	Q2/93	1802	199	19	9	0	23	2	140	121	2	2317	1.13	9
	Q3/93	1881	164	15	7	0	27	2	110	162	5	2373	1.10	9
	Q4/93	654	72	7	2	0	1	2	49	28	0	815	1.13	3
	Q1/94	1539	109	15	4	1	3	1	94	120	2	1888	1.09	8
	Q2/94	927	77	8	3	0	3	0	57	74	1	1150	1.10	4
	Q3/94	940	58	5	2	0	22	2	61	81	5	1176	1.07	5
	Q4/94	1344	126	10	2	3	13	3	105	94	2	1702	1.10	8
	Q1/95	870	65	3	3	0	3	1	73	62	0	1080	1.09	5
	Q2/95	1095	98	9	1	2	11	0	58	68	0	1342	1.10	5
	Q3/95	No observations											--	

90

**p.m. eastbound**

	Qtr.	1	2	3	4+	Van	Public Transit	Other Bus	2 Axle	3+ Axle	Motor- cycle	TOTAL OBS.	ACO	Counts
Off ramp	Q3/92	4565	844	153	71	1	35	6	160	187	39	6061	1.24	17
	Q4/92	2748	435	45	13	2	7	1	116	77	5	3449	1.17	7
	Q1/93	1873	262	44	8	2	9	3	55	69	8	2333	1.17	7
	Q2/93	No observations											--	
	Q3/93	3568	746	85	59	0	23	2	151	135	19	4788	1.25	14
	Q4/93	1784	355	43	17	0	2	0	77	61	4	2343	1.25	8
	Q1/94	3322	547	74	26	1	26	4	122	86	2	4210	1.20	10
	Q2/94	1939	345	14	8	74	10	2	81	54	24	2484	1.17	5
	Q3/94	4005	757	76	35	18	25	4	187	136	21	5264	1.21	13
	Q4/94	3452	566	72	51	0	10	1	152	148	4	4456	1.21	10
	Q1/95	1650	214	10	6	0	3	3	75	64	2	2027	1.13	5
	Q2/95	1871	414	28	18	3	15	0	72	96	2	2519	1.23	5
	Q3/95	No observations											--	

101

**Note:** This is a very busy ramp, so it is a good idea to have a vest with you for visibility and safety.

**SITES #45, 46, & 47. SR 520 - 148th Avenue NE**

- ▲ ACO mainline WB-am & EB-pm
- ACO on/ramp WB from Bellevue-am & from Redmond-am
- ACO off/ramp EB to Bellevue-pm & to Redmond-pm

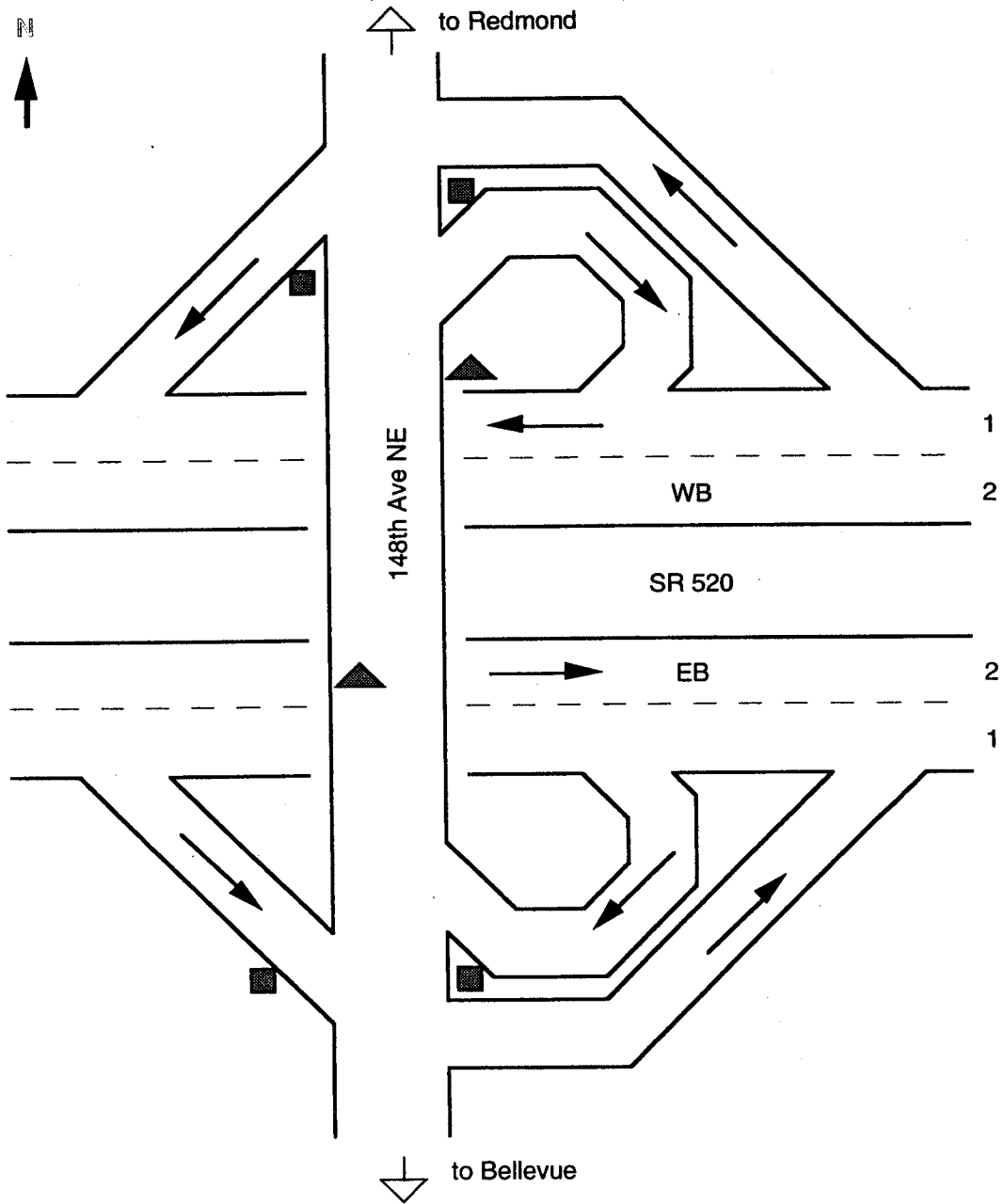

**Note:** To count ACO mainline westbound in the morning, you must walk down the east side of 148th NE and go behind the concrete overpass barrier to find a place to sit in the grassy embankment. You will be looking down and to the side to see the mainline traffic.

To count ACO mainline eastbound in the afternoon, you can sit on the sidewalk on the west side of the 148th NE overpass. The entrance and exit ramps in this location are split, so you have to look carefully to be sure you are counting the correct ramp.

**SR 520 - 148th Avenue NE**

**a.m. westbound**

	Qtr.	1	2	3	4+	Van	Public Transit	Other Bus	2 Axle	3+ Axle	Motor- cycle	TOTAL OBS.	ACO	Counts
GP lanes	Q3/92	5289	533	51	15	3	13	0	172	77	16	6169	1.12	12
	Q4/92	No observations											--	
3	Q1/93	1971	191	13	6	1	5	2	46	18	4	2257	1.11	4
	Q2/93	3472	238	14	5	0	17	3	89	68	6	3912	1.08	10
	Q3/93	8786	640	49	45	4	29	10	230	145	67	10005	1.09	27
	Q4/93	2128	214	32	13	1	14	0	100	59	5	2566	1.13	6
	Q1/94	6326	609	74	13	5	14	6	249	58	9	7363	1.11	14
	Q2/94	5872	402	44	33	0	15	5	225	124	22	6742	1.09	23
	Q3/94	8852	379	25	11	2	35	5	328	158	46	9841	1.05	21
	Q4/94	5008	351	23	10	1	17	6	193	90	7	5706	1.08	12
	Q1/95	3748	220	9	4	1	9	8	108	67	1	4175	1.06	5
	Q2/95	6978	462	40	11	5	21	8	197	118	11	7851	1.08	15
	Q3/95	3922	172	9	8	5	6	7	101	44	22	4296	1.05	17
	No observations conducted Q4/95 - Q2/96												-	
	Q3/96	5874	335	25	11	8	16	5	169	88	11	6542	1.07	15
	No observations conducted Q4/96 - Q1/97												-	
	Q2/97	10425	582	29	2	9	32	8	271	159	16	11533	1.06	22
	Q3/97	11867	588	49	15	14	31	2	277	231	23	13097	1.06	22
	No observations conducted Q4/97 - Q1/98												-	
	Q2/98	12958	1298	113	40	22	31	20	596	278	39	15393	1.11	26

251



**SR 520 - 148th Avenue NE**

**p.m. eastbound**

	Qtr.	1	2	3	4+	Van	Public Transit	Other Bus	2 Axle	3+ Axle	Motor- cycle	TOTAL OBS.	ACO	Counts
GP lanes	Q3/92	2446	465	46	9	1	8	2	50	30	18	3075	1.20	7
	Q4/92	2435	389	31	5	1	9	2	61	27	13	2973	1.16	7
2	Q1/93	No observations											--	
	Q2/93	3633	584	28	4	1	14	1	101	21	14	4401	1.15	9
	Q3/93	9387	1296	153	36	4	32	6	272	98	55	11339	1.16	24
	Q4/93	7176	845	37	8	5	27	3	215	81	25	8422	1.12	22
	Q1/94	4619	694	65	32	2	13	3	119	67	11	5625	1.17	12
	Q2/94	7942	996	150	74	1	22	6	200	80	22	9493	1.17	20
	Q3/94	7850	706	41	13	17	34	4	183	84	50	8982	1.10	16
	Q4/94	3515	421	38	21	1	11	2	85	41	7	4142	1.14	9
	Q1/95	5640	681	71	28	2	21	6	148	95	12	6704	1.14	5
	Q2/95	6099	1183	102	57	11	28	9	160	105	23	8377	1.20	16
	Q3/95	8417	1078	112	32	19	30	10	167	105	47	10017	1.15	18
	No observations conducted Q4/95 - Q2/96											-		
	Q3/96	8347	1038	143	34	13	28	5	166	98	35	9907	1.15	18
	No observations conducted Q4/96 - Q1/97											-		
	Q2/97	3821	645	64	33	8	18	1	124	20	20	4754	1.19	10
	Q3/97	6229	1466	257	87	66	31	3	114	84	33	8370	1.28	18
	No observations conducted Q4/97 - Q1/98											-		
	Q2/98	16972	2422	251	78	25	34	32	499	147	50	20510	1.16	32
														243

**SR 520 - 148th Avenue NE**

**a.m. westbound - Redmond Ramp**

	Qtr.	1	2	3	4+	Van	Public Transit	Other Bus	2 Axle	3+ Axle	Motor- cycle	TOTAL OBS.	ACO	Counts	
On ramp	Q3/92	2068	242	44	16	2	23	2	24	11	4	2436	1.16	13	
	Q4/92	782	106	9	5	0	10	0	4	3	0	919	1.16	6	
	Q1/93	1792	230	20	14	1	24	2	170	3	2	2258	1.15	11	
	Q2/93	1096	105	18	4	0	14	0	171	1	3	1413	1.13	8	
	Q3/93	804	91	16	5	0	5	0	17	5	2	945	1.15	9	
	Q4/93	1021	109	7	8	0	12	1	22	2	0	1182	1.13	9	
	Q1/94	543	67	2	2	0	7	2	13	3	1	640	1.13	4	
	Q2/94	547	89	5	0	2	6	1	7	5	0	662	1.15	4	
	Q3/94	1502	180	11	9	3	16	2	24	11	5	1763	1.14	10	
	Q4/94	1132	75	8	7	1	12	0	13	9	2	1259	1.09	8	
	Q1/95	1167	85	10	3	1	13	3	13	9	4	1308	1.09	8	
	Q2/95	2379	171	22	4	2	20	1	27	15	8	2378	1.10	11	
	Q3/95	No observations											--		

101

**p.m. eastbound - Redmond Ramp**

	Qtr.	1	2	3	4+	Van	Public Transit	Other Bus	2 Axle	3+ Axle	Motor- cycle	TOTAL OBS.	ACO	Counts	
Off ramp	Q3/92	1038	171	35	30	1	12	0	11	6	8	1312	1.26	9	
	Q4/92	1583	225	24	6	0	21	0	21	12	2	1894	1.16	15	
	Q1/93	No observations											--		
	Q2/93	488	85	6	1	0	2	0	9	3	3	597	1.17	4	
	Q3/93	1807	355	75	36	1	14	3	16	7	6	2320	1.27	9	
	Q4/93	470	31	2	16	2	6	0	2	0	0	529	1.17	4	
	Q1/94	2190	294	39	12	3	17	0	20	3	3	2581	1.16	10	
	Q2/94	570	110	16	3	0	5	1	8	1	3	717	1.22	5	
	Q3/94	1417	242	44	32	3	12	1	20	4	7	1782	1.25	11	
	Q4/94	830	85	14	3	1	6	0	7	7	4	957	1.13	6	
	Q1/95	1010	191	17	10	0	6	0	21	11	1	1267	1.21	9	
	Q2/95	565	103	17	6	5	6	0	4	3	0	709	1.23	10	
	Q3/95	No observations											--		

92

**SR 520 - 148th Avenue NE**

**a.m. westbound - Bellevue Ramp**

	Qtr.	1	2	3	4+	Van	Public Transit	Other Bus	2 Axle	3+ Axle	Motor- cycle	TOTAL OBS.	ACO	Counts
On ramp	Q3/92	2657	274	47	28	0	26	1	36	10	6	3085	1.15	12
	Q4/92	1383	128	10	1	2	13	2	8	6	1	1554	1.10	7
	Q1/93	2987	289	29	2	2	25	2	45	13	2	3396	1.11	14
	Q2/93	2035	240	28	14	2	27	8	17	17	10	2398	1.15	9
	Q3/93	1770	170	21	16	0	13	4	24	10	9	2037	1.13	10
	Q4/93	676	73	10	6	7	11	1	10	12	3	807	1.15	3
	Q1/94	750	88	9	5	4	7	0	9	4	0	876	1.14	4
	Q2/94	988	107	6	4	5	9	1	15	8	2	1145	1.12	5
	Q3/94	2279	225	26	18	8	23	0	50	10	8	2647	1.13	10
	Q4/94	961	51	10	6	1	8	3	15	12	1	1068	1.09	7
	Q1/95	1522	136	18	4	2	13	3	24	17	1	1740	1.11	8
	Q2/95	1895	174	26	5	11	17	2	28	20	4	2182	1.12	10
	Q3/95	No observations											--	

99

**p.m. eastbound - Bellevue Ramp**

	Qtr.	1	2	3	4+	Van	Public Transit	Other Bus	2 Axle	3+ Axle	Motor- cycle	TOTAL OBS.	ACO	Counts
Off ramp	Q3/92	2397	503	103	55	4	15	6	15	11	14	3123	1.29	11
	Q4/92	4177	621	79	24	3	25	7	59	10	5	5010	1.17	14
	Q1/93	1038	141	17	1	1	4	2	2	0	3	1209	1.15	3
	Q2/93	1507	271	47	19	1	7	4	22	1	11	1890	1.23	5
	Q3/93	3658	703	136	85	3	23	4	42	16	12	4682	1.17	16
	Q4/93	1908	435	88	52	6	10	1	19	9	7	2535	1.31	9
	Q1/94	1960	348	51	8	3	14	1	15	1	6	2407	1.20	6
	Q2/94	1648	301	43	5	1	9	0	8	2	10	2027	1.20	5
	Q3/94	1859	403	77	42	10	12	1	10	3	9	2416	1.29	9
	Q4/94	3084	543	66	21	7	24	1	33	7	12	3798	1.20	9
	Q1/95	3687	752	65	30	4	23	1	41	7	11	4621	1.22	10
	Q2/95	3821	690	83	12	7	26	1	35	6	18	4699	1.19	11
	Q3/95	No observations											--	

108

### Vehicle Occupancy (ACO) Sites I-90 (Corridor #5)

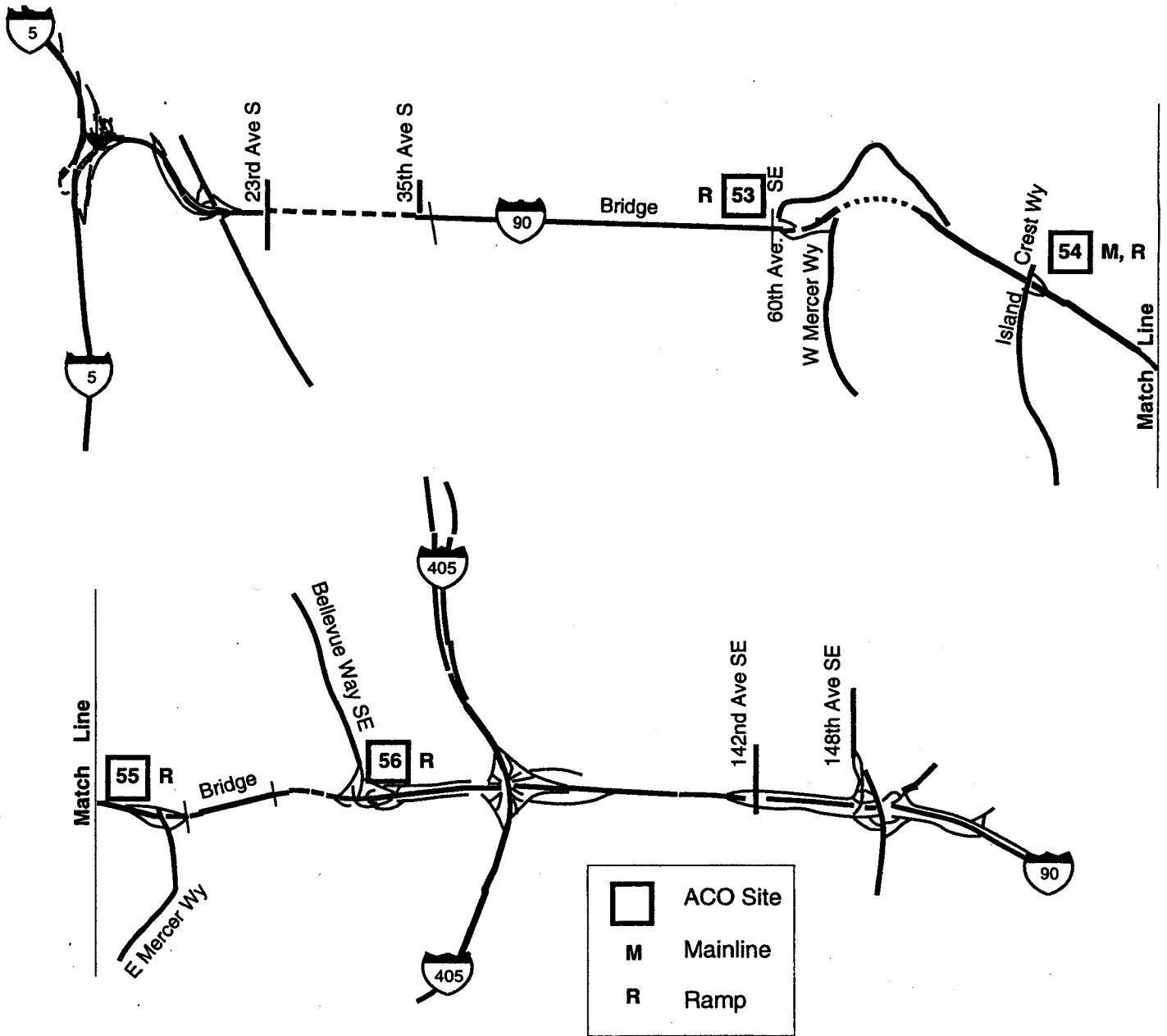

**SITE #52. I-90 Reversible Lanes**

- ACO reversible lanes WB-am
- ACO reversible lanes EB-pm

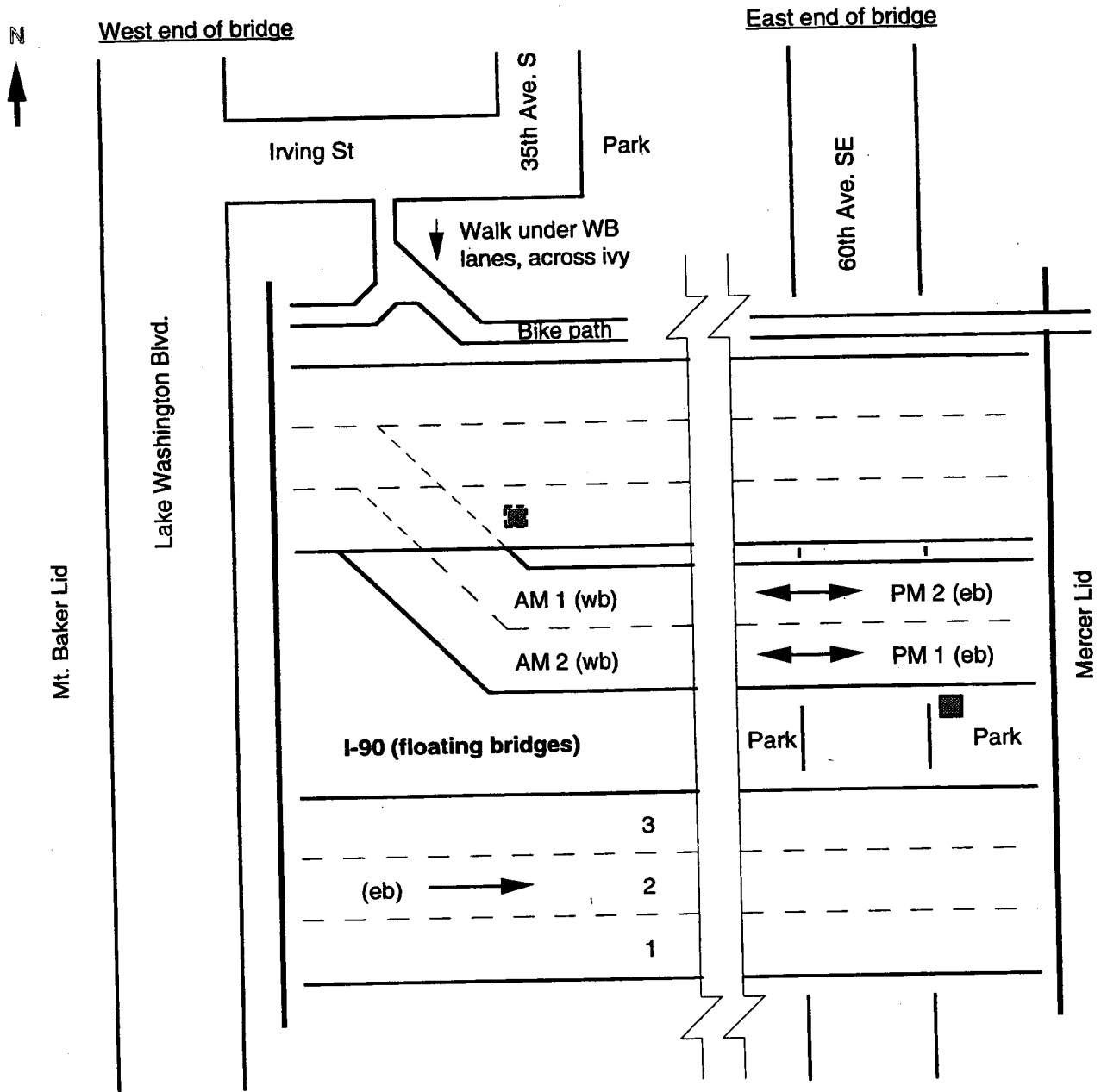

**Note: The two lanes in the center roadway are for use by HOVs and Mercer Island SOVs.**

## I-90 Reversible Lanes

### a.m. westbound

	Qtr.	1	2	3	4+	Van	Public Transit	Other Bus	2 Axle	3+ Axle	Motor- cycle	TOTAL OBS.	ACO	Counts
Reversible	Q3/94	1004	811	56	22	6	37	0	7	0	41	1984	1.52	9
Lanes	Q4/94	752	1837	46	22	4	54	5	8	0	17	2745	1.75	11
	Q1/95	8	2612	39	28	7	67	9	9	0	14	2793	2.03	13
	Q2/95	1712	1683	141	34	23	77	5	12	2	73	3762	1.58	15
	Q3/95	859	1008	62	25	6	53	2	11	0	35	2061	1.62	15
	Observations suspended Q4/95- 2/97											-		
	Q3/97	1762	1168	60	24	15	54	2	9	2	17	3113	1.45	8
	No observations conducted Q4/97 - Q1/98													
	Q2/98	2418	2259	284	94	57	96	11	65	5	49	5338	1.62	19
														90

### p.m. eastbound

	Qtr.	1	2	3	4+	Van	Public Transit	Other Bus	2 Axle	3+ Axle	Motor- cycle	TOTAL OBS.	ACO	Counts
Reversible	Q3/94	1141	1486	163	82	21	60	2	14	0	68	3307	1.66	12
Lanes	Q4/94	1256	1983	144	56	15	78	5	15	1	39	3592	1.71	16
	Q1/95	1685	2048	210	60	18	85	9	25	0	33	4173	1.66	22
	Q2/95	1444	1661	134	64	25	46	6	8	0	26	3414	1.65	17
	Q3/95	2496	2278	269	67	31	82	3	15	1	59	5301	1.59	16
	Observations suspended Q4/95 - 2/97											-		
	Q3/97	1355	1847	339	150	86	76	9	16	0	51	3929	1.81	15
	No observations conducted Q4/97 - Q1/98													
	Q2/98	5181	4611	569	183	105	179	22	121	2	95	11068	1.60	31
														48

**SITE #53. I-90 - 60th Avenue SE**

- ACO on/ramp WB-am
- ACO off/ramp EB-pm

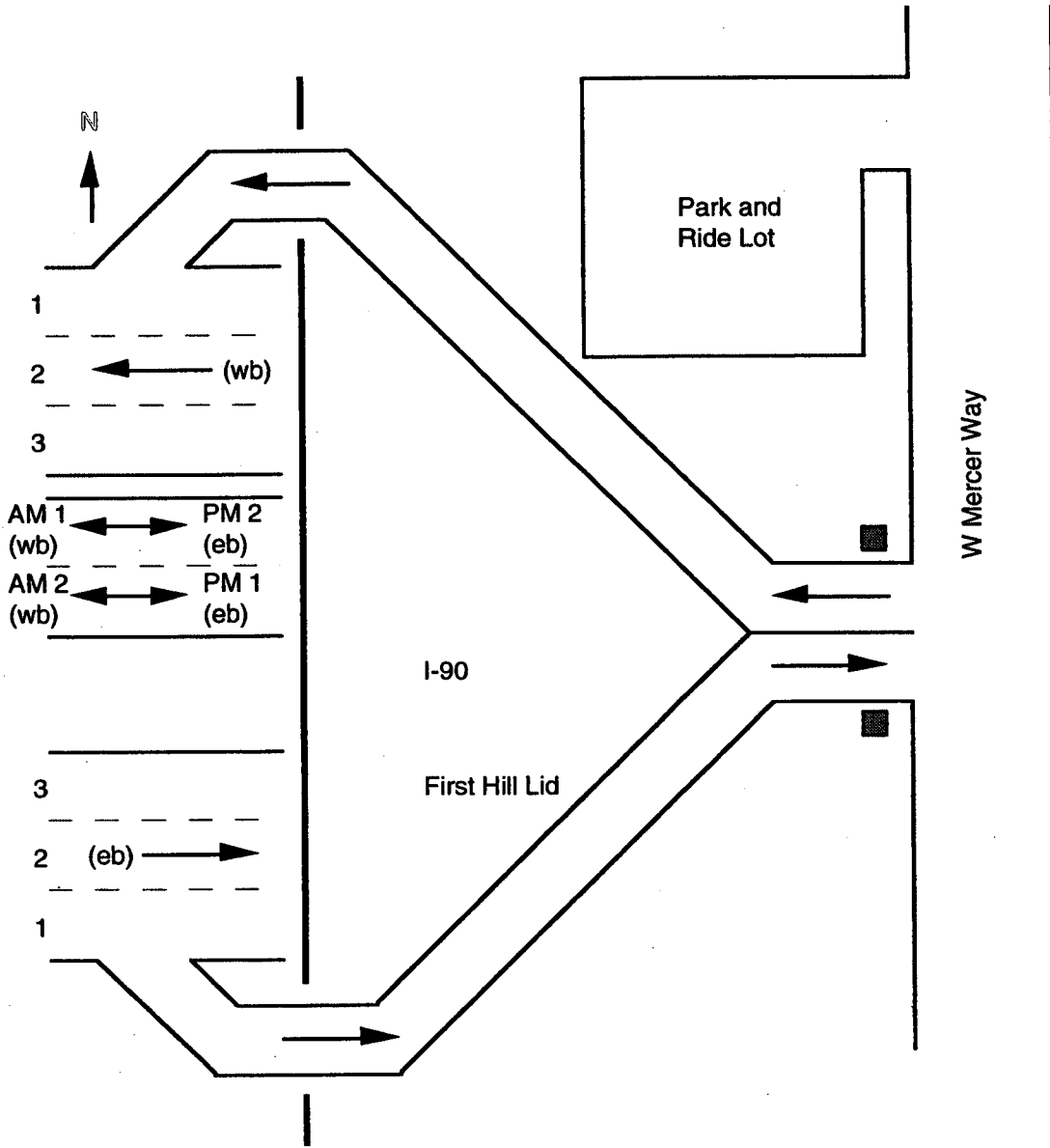

**I-90 - 60th Avenue SE**

**a.m. westbound**

	Qtr.	1	2	3	4+	Van	Public Transit	Other Bus	2 Axle	3+ Axle	Motor- cycle	TOTAL ACO OBS.	Counts	
On ramp	Q3/92	1570	185	21	10	0	18	1	6	2	1	1814	1.15	13
	Q4/92	1201	154	13	6	0	15	2	7	1	2	1401	1.14	8
	Q1/93	1697	166	12	3	0	18	1	5	1	0	1903	1.11	10
	Q2/93	538	59	17	1	0	7	1	9	0	0	632	1.16	4
	Q3/93	1211	120	13	5	1	14	1	8	11	1	1385	1.12	9
	Q4/93	550	53	3	1	0	7	3	2	4	0	623	1.10	3
	Q1/94	767	77	7	4	0	7	3	19	2	2	878	1.12	8
	Q2/94	397	33	5	2	0	6	1	4	2	0	450	1.11	3
	Q3/94	544	65	6	1	1	8	0	1	6	1	633	1.13	6
	Q4/94	517	48	8	5	0	8	1	1	2	1	591	1.14	5
	Q1/95	945	74	5	1	0	17	3	6	3	0	1054	1.09	13
	Q2/95	544	51	9	3	1	11	1	1	3	0	624	1.13	6
	Q3/95	No observations											--	

88

**p.m. eastbound**

	Qtr.	1	2	3	4+	Van	Public Transit	Other Bus	2 Axle	3+ Axle	Motor- cycle	TOTAL ACO OBS.	Counts	
Off ramp	Q3/92	1256	278	52	28	0	13	0	8	2	6	1643	1.29	10
	Q4/92	2269	301	37	17	0	22	8	34	1	4	2693	1.16	14
	Q1/93	1110	220	40	11	0	16	1	465	0	4	1867	1.24	12
	Q2/93	956	189	30	18	0	12	1	156	1	1	1364	1.26	9
	Q3/93	No observations											--	
	Q4/93	1148	198	25	13	0	16	3	18	0	1	1422	1.21	13
	Q1/94	480	76	15	7	0	9	1	1	1	1	591	1.22	6
	Q2/94	1057	226	47	17	5	15	0	5	0	3	1375	1.28	16
	Q3/94	1597	258	56	33	4	23	2	17	5	9	2004	1.24	17
	Q4/94	939	96	9	6	2	12	3	5	0	1	1073	1.13	9
	Q1/95	557	70	9	2	1	12	1	3	1	0	656	1.15	6
	Q2/95	743	145	13	9	4	14	0	1	3	1	933	1.22	8
	Q3/95	No observations											--	

120



**SITE #54. I-90 - Island Crest Way**

- ACO on/ramp WB-am
- ACO off/ramp EB-pm
- ▲ ACO mainline WB-am
- ▲ ACO mainline EB-pm

For Period Ending Q1/94: See following pages for data after HOV lane opened.

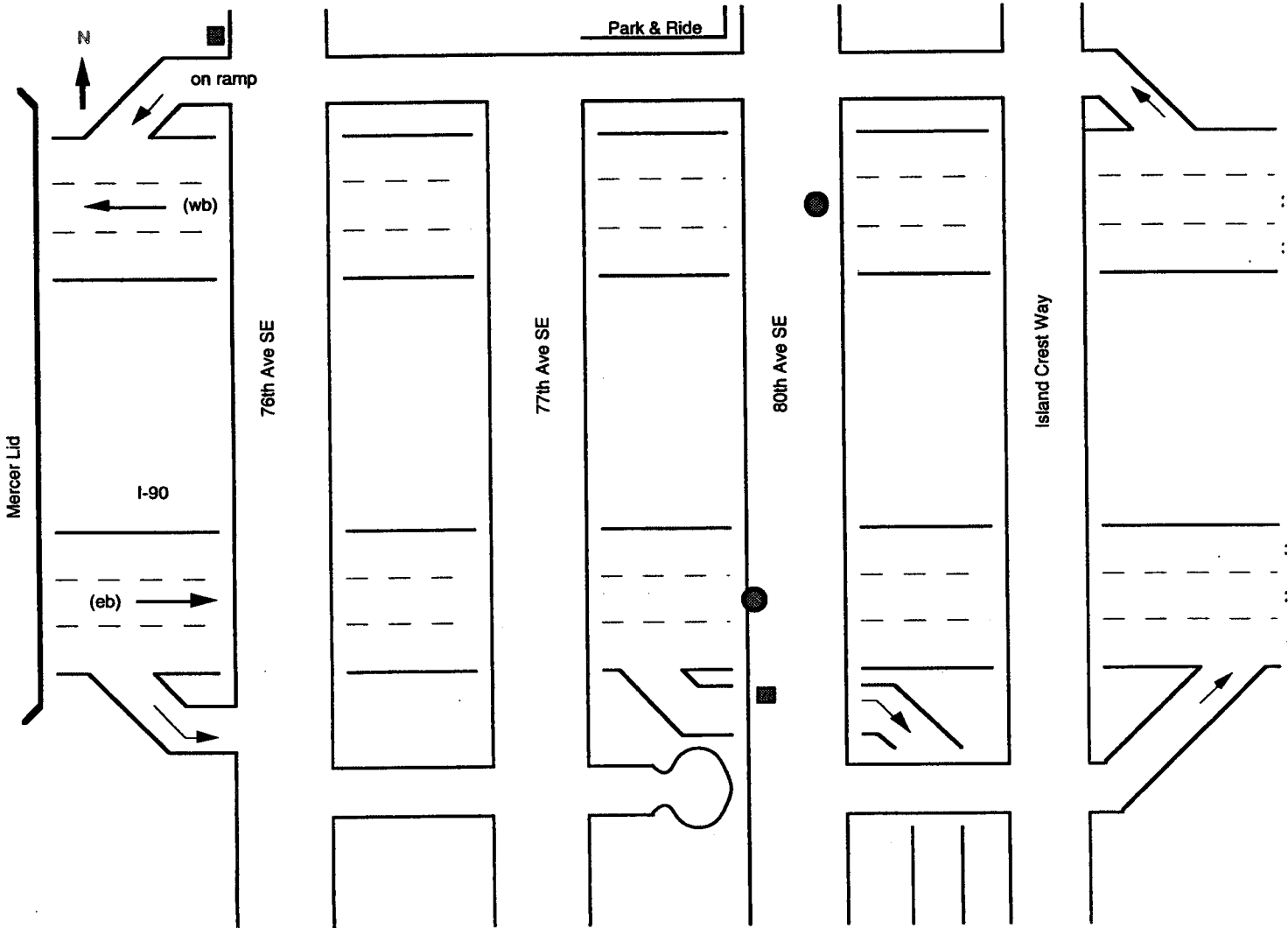

Note: The interim outside mainline westbound HOV lane was removed when the reversible center roadway was open to use during Q1/94

### I-90 - Island Crest Way

#### a.m. westbound

	Qtr.	1	2	3	4+	Van	Public Transit	Other Bus	2 Axle	3+ Axle	Motor- cycle	TOTAL OBS.	ACO	Counts
HOV lanes 1	Q3/92	26	919	84	15	4	46	2	0	1	49	1146	2.09	7
	Q4/92	No observations											--	
	Q1/93	No observations											--	
	Q2/93	5	311	15	6	0	8	3	2	0	4	354	2.07	2
	Q3/93	22	735	131	47	0	30	1	6	1	22	995	2.23	4
	Q4/93	29	409	34	13	0	18	1	3	0	5	512	2.07	3
	Q1/94	10	149	16	4	1	5	1	1	0	1	188	2.08	1
GP lanes 3	Q3/92	4777	294	18	6	0	1	0	56	93	4	5249	1.07	13
	Q4/92	No observations											--	
	Q1/93	No observations											--	
	Q2/93	4863	156	18	7	3	17	1	82	114	2	5263	1.04	10
	Q3/93	8561	421	54	23	3	3	5	128	158	8	9364	1.07	15
	Q4/93	4869	84	5	4	1	0	1	39	76	2	5081	1.02	9
	Q1/94	5845	321	48	13	0	0	0	81	118	0	6426	1.07	7
														54

#### p.m. eastbound

	Qtr.	1	2	3	4+	Van	Public Transit	Other Bus	2 Axle	3+ Axle	Motor- cycle	TOTAL OBS.	ACO	Counts
GP lanes 3	Q3/92	14886	2890	319	112	9	60	5	156	204	83	18724	1.21	28
	Q4/92	2139	278	23	7	2	8	6	19	30	5	2517	1.14	4
	Q1/93	5904	708	26	4	2	0	5	85	72	4	6810	1.12	9
	Q2/93	9828	1165	45	18	1	1	7	1024	144	21	12254	1.12	21
	Q3/93	12609	2045	276	44	3	5	16	161	230	39	15428	1.18	19
	Q4/93	12012	2156	197	65	10	11	5	227	176	29	14888	1.19	21
	Q1/94	6426	745	60	8	0	1	2	61	83	11	7397	1.12	11

**I-90 - Island Crest Way**

**a.m. westbound**

	Qtr.	1	2	3	4+	Van	Public Transit	Other Bus	2 Axle	3+ Axle	Motor- cycle	TOTAL OBS.	ACO	Counts	
On ramp	Q3/92	2351	351	41	10	3	38	2	22	9	3	2830	1.17	15	
	Q4/92	989	111	8	1	0	0	3	2	1	0	1115	1.12	5	
	Q1/93	No observations											--		
	Q2/93	480	73	7	2	0	19	0	197	2	1	781	1.17	5	
	Q3/93	1148	157	16	5	2	37	0	19	3	1	1388	1.15	14	
	Q4/93	906	120	21	5	1	22	1	8	3	3	1090	1.17	6	
	Q1/94	967	91	8	4	0	28	1	8	4	1	1112	1.11	7	
															52

**p.m. eastbound**

	Qtr.	1	2	3	4+	Van	Public Transit	Other Bus	2 Axle	3+ Axle	Motor- cycle	TOTAL OBS.	ACO	Counts
Off ramp	Q3/92	2725	476	101	25	0	1	2	14	3	12	3359	1.23	24
	Q4/92	2253	272	40	16	2	0	0	7	1	0	2591	1.16	19
	Q1/93	1422	207	18	10	0	0	6	9	0	0	1672	1.17	15
	Q2/93	1888	391	39	7	0	0	0	8	3	2	2338	1.21	22
	Q3/93	1338	317	27	2	0	22	2	9	1	2	1720	1.22	19
	Q4/93	2741	499	86	31	0	0	6	17	1	1	3382	1.23	22
	Q1/94	723	167	34	9	0	0	2	6	3	1	945	1.28	11

**Site # 54. I-90 - Island Crest Way**

**Beginning Q2/94: See preceding pages for data prior to HOV lane completion.**

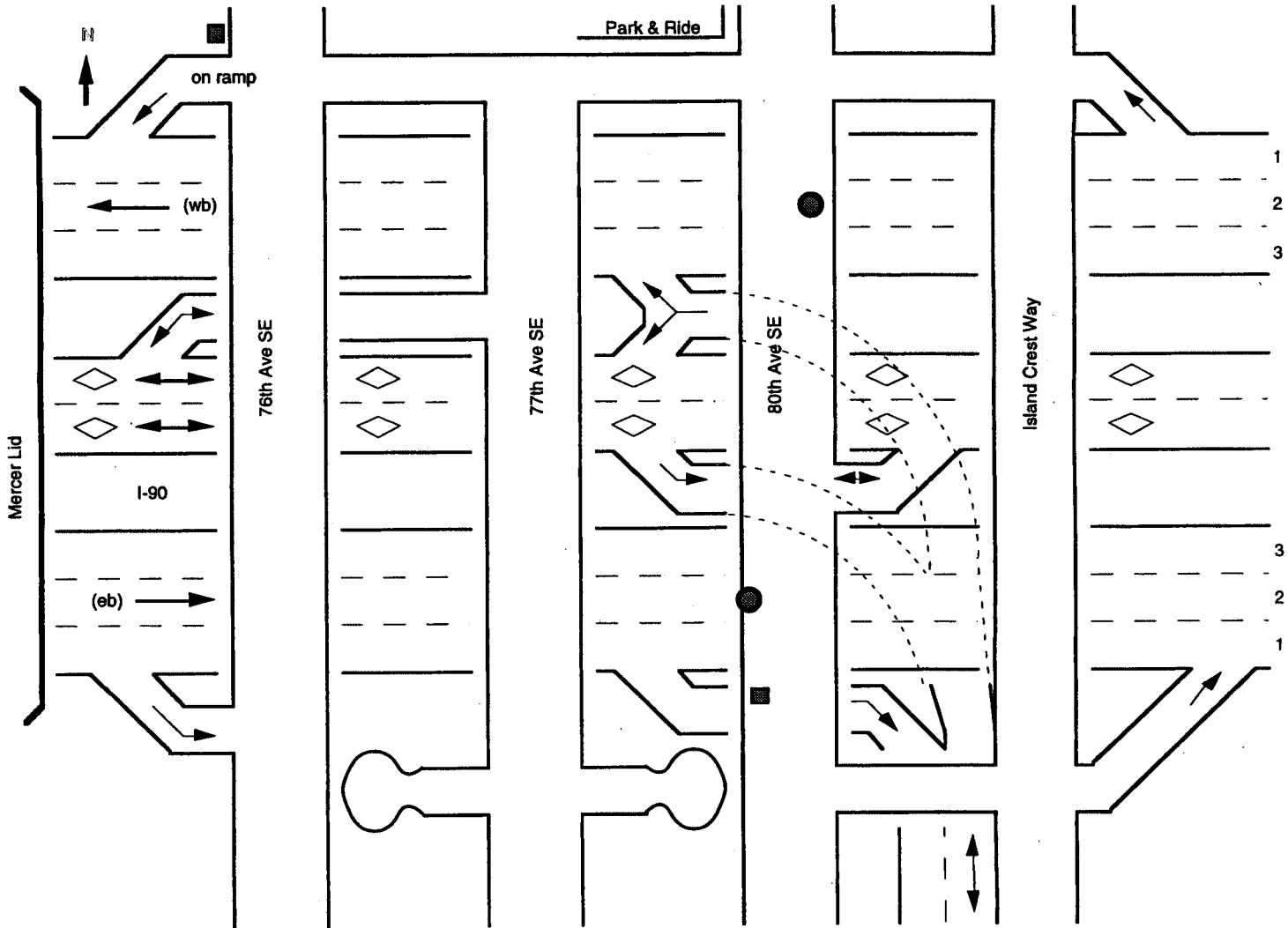

**Note:** The on/ramp westbound at this location is actually located at 76th Avenue SE. Occasionally the sprinklers in the landscaping will turn on unexpectedly, so it is a good idea to always have plastic bags and ponchos with you when you count at this location! HOV lanes are counted at Site #52.

**I-90 - Island Crest Way**

**a.m. westbound**

	Qtr.	1	2	3	4+	Van	Public Transit	Other Bus	2 Axle	3+ Axle	Motor- cycle	TOTAL OBS.	ACO	Counts	
GP lanes 3	Q2/94	9220	484	47	18	2	3	0	112	185	8	10079	1.07	14	
	Q3/94	7988	442	56	15	1	1	3	123	185	9	8823	1.07	15	
	Q4/94	5467	143	13	3	0	1	3	63	115	2	5807	1.03	11	
	Q1/95	6318	191	7	29	0	6	4	107	125	0	6787	1.05	11	
	Q2/95	5822	185	8	4	1	0	1	73	142	17	6253	1.04	12	
	Q3/95	5552	205	15	6	0	0	1	85	141	3	6008	1.04	14	
	No observations conducted Q4/95 - Q2/96												-		
	Q3/96	5658	116	10	4	1	2	4	64	163	1	6023	1.03	9	
	No observations conducted Q4/96 - Q1/97												-		
	Q2/97	12483	389	24	11	4	3	5	116	292	1	13328	1.04	21	
	Q3/97	9676	214	18	9	6	5	6	81	208	3	10226	1.03	15	
	No observations conducted Q4/97 - Q1/98												-		
	Q2/98	17288	636	33	7	9	2	16	304	409	2	18706	1.04	28	
<b>150</b>															

**p.m. westbound**

	Qtr.	1	2	3	4+	Van	Public Transit	Other Bus	2 Axle	3+ Axle	Motor- cycle	TOTAL OBS.	ACO	Counts	
GP lanes 3	Q3/97	5916	1354	217	118	59	39	11	128	84	35	7961	1.28	14	
	No observations conducted Q4/97 - Q1/98												-		
	Q2/98	17424	3307	299	92	46	108	23	469	280	73	22121	1.20	30	
<b>44</b>															

**a.m. eastbound**

	Qtr.	1	2	3	4+	Van	Public Transit	Other Bus	2 Axle	3+ Axle	Motor- cycle	TOTAL OBS.	ACO	Counts
GP lanes 3	Q2/97	5631	563	26	17	8	30	6	110	102	31	6524	1.11	12
	Q3/97	5817	445	20	4	18	26	8	100	149	19	6606	1.08	10
	No observations conducted Q4/97 - Q1/98												-	
Q2/98	13296	1251	111	37	47	102	19	450	331	64	15708	1.11	28	
<b>50</b>														

**I-90 - Island Crest Way**

**p.m. eastbound**

	Qtr.	1	2	3	4+	Van	Public Transit	Other Bus	2 Axle	3+ Axle	Motor- cycle	TOTAL OBS.	ACO	Counts	
GP lanes 3	Q2/94	13065	1114	173	121	1	2	8	199	227	24	14934	1.13	20	
	Q3/94	12417	1155	194	136	11	0	4	166	239	19	14341	1.14	27	
	Q4/94	7279	625	59	35	2	0	1	137	129	7	8274	1.11	14	
	Q1/95	11356	983	54	33	9	0	4	124	184	12	12759	1.10	18	
	Q2/95	8286	685	40	16	2	0	2	104	144	20	9299	1.09	14	
	Q3/95	10638	936	147	45	19	0	2	131	181	16	12115	1.12	18	
	No observations conducted Q4/95 - Q2/96												-		
	Q3/96	10684	765	81	46	4	0	3	97	203	8	11891	1.09	17	
	No observations conducted Q4/96 - Q1/97												-		
	Q2/97	5714	459	19	4	6	0	1	61	95	11	6370	1.08	9	
	Q3/97	6187	553	73	35	21	4	4	60	150	9	7096	1.12	13	
	No observations conducted Q4/97 - Q1/98												-		
	Q2/98	19280	1966	254	64	5	20	24	344	394	24	22375	1.12	31	
	<b>181</b>														

**a.m. westbound**

	Qtr.	1	2	3	4+	Van	Public Transit	Other Bus	2 Axle	3+ Axle	Motor- cycle	TOTAL OBS.	ACO	Counts
On ramp	Q2/94	1727	171	17	7	0	25	0	43	9	1	2000	1.12	15
	Q3/94	1109	109	16	2	0	16	0	20	8	3	1283	1.12	10
	Q4/94	696	50	8	1	1	7	1	13	5	0	782	1.09	8
	Q1/95	565	41	4	1	0	5	0	12	2	0	630	1.09	7
	Q2/95	979	89	7	2	0	6	0	15	9	1	1108	1.10	10
	Q3/95	No observations											--	
<b>50</b>														

**p.m. eastbound**

	Qtr.	1	2	3	4+	Van	Public Transit	Other Bus	2 Axle	3+ Axle	Motor- cycle	TOTAL OBS.	ACO	Counts
Off ramp	Q2/94	328	73	13	4	2	0	2	5	1	2	930	1.27	7
	Q3/94	912	219	46	20	2	0	0	10	4	0	1213	1.31	17
	Q4/94	641	92	15	9	0	0	2	8	4	0	771	1.20	10
	Q1/95	532	87	22	10	0	0	0	4	0	0	655	1.25	9
	Q2/95	369	89	12	5	0	0	0	5	1	0	481	1.27	10
Q3/95	No observations											--		
<b>53</b>														

**SITE #55. I-90 - East Mercer Way**

- ACO on/ramp WB-am
- ACO off/ramp EB-pm

Ending Q1/94

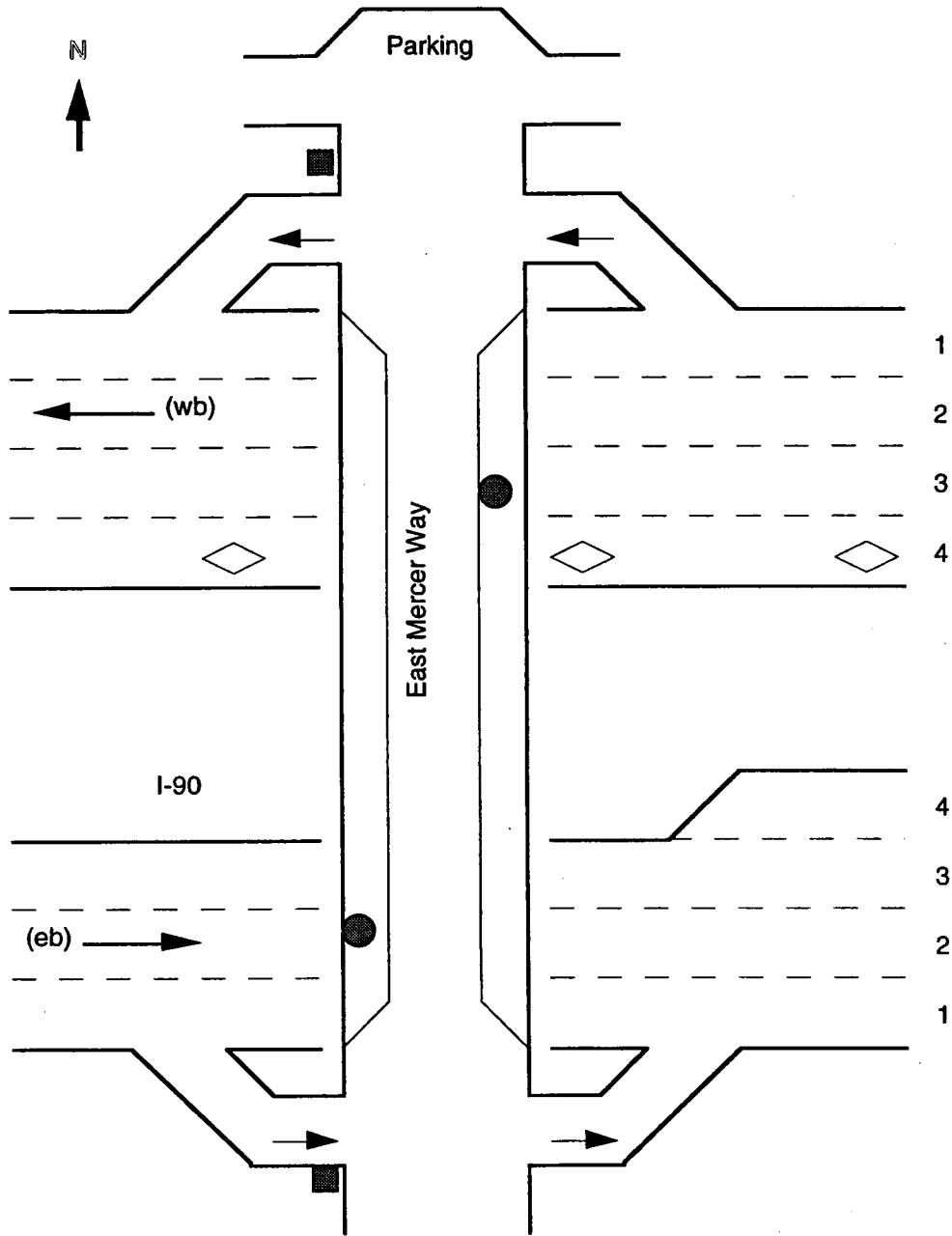

**I-90 - East Mercer Way**

**a.m. westbound**

	Qtr.	1	2	3	4+	Van	Public Transit	Other Bus	2 Axle	3+ Axle	Motor- cycle	TOTAL OBS.	ACO	Counts
On ramp	Q3/92	213	23	6	0	0	4	0	3	0	1	250	1.14	5
	Q4/92	406	36	7	2	0	4	1	3	2	0	461	1.13	3
	Q1/93	36	6	1	0	0	0	0	0	0	0	43	1.19	1
	Q2/93	No observations											--	
	Q3/93	No observations											--	
	Q4/93	217	10	0	0	0	4	0	1	0	0	232	1.04	3
	Q1/94	301	35	2	2	0	6	0	3	0	0	349	1.13	8
														20

**p.m. eastbound**

	Qtr.	1	2	3	4+	Van	Public Transit	Other Bus	2 Axle	3+ Axle	Motor- cycle	TOTAL OBS.	ACO	Counts
Off ramp	Q3/92	No observations											--	
	Q4/92	No observations											--	
	Q1/93	199	47	2	2	0	6	0	1	0	0	257	1.23	6
	Q2/93	241	51	10	6	0	6	0	4	0	1	319	1.29	5
	Q3/93	No observations											--	
	Q4/93	608	138	30	16	0	16	1	3	0	1	813	1.31	15
	Q1/94	223	44	13	3	0	6	0	6	0	1	296	1.28	5
														31



**I-90 - East Mercer Way**

Beginning Q2/94

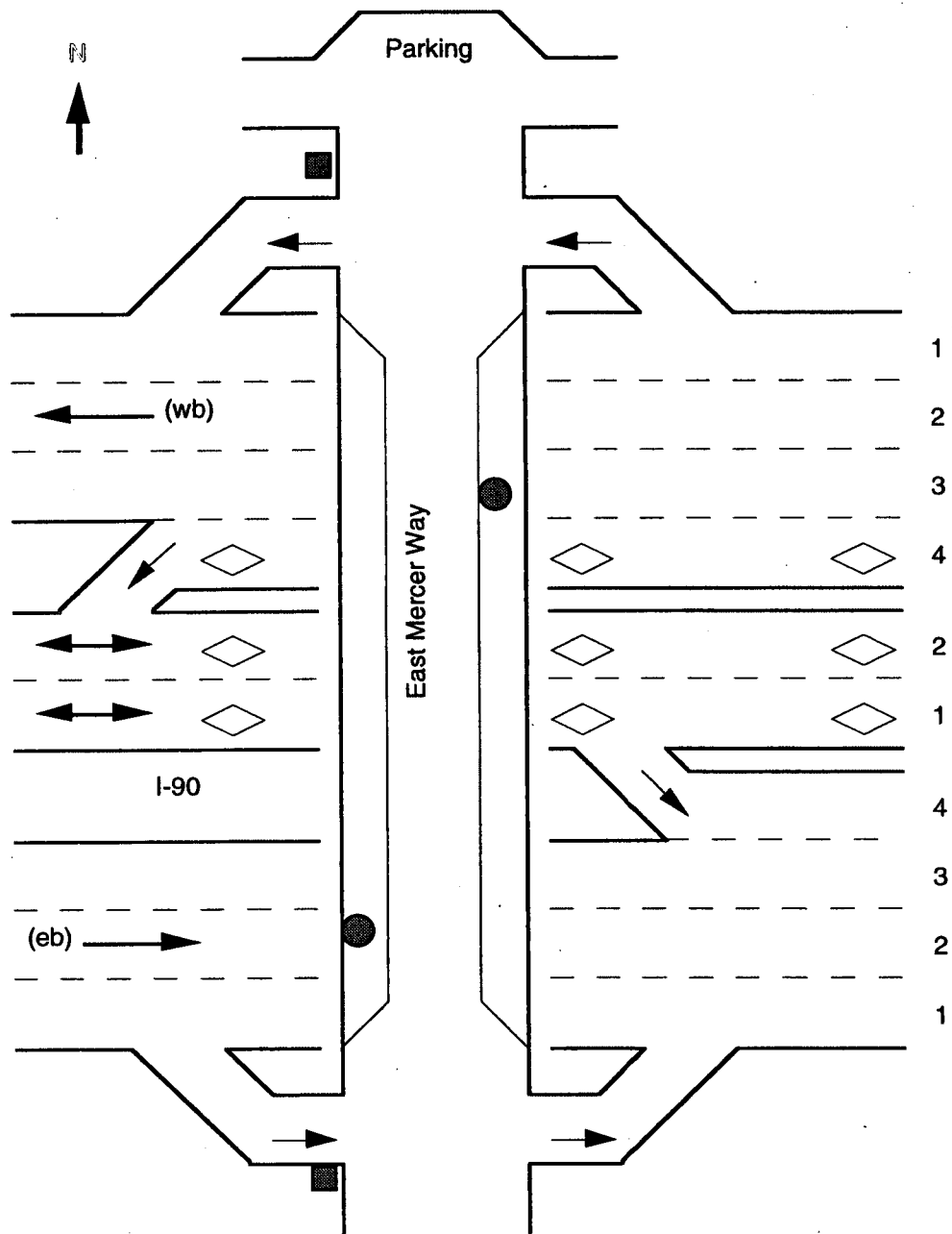

Note: Observations suspended as of Q4/94 and may resume at a later date.

**I-90 - East Mercer Way**

**a.m. westbound**

	Qtr.	1	2	3	4+	Van	Public Transit	Other Bus	2 Axle	3+ Axle	Motor- cycle	TOTAL OBS.	ACO	Counts
On ramp	Q2/94	150	16	0	0	0	4	0	0	1	0	171	1.10	4
	Q3/94	174	14	2	0	0	4	1	0	0	0	195	1.09	5
	Q4/94	No observations											- -	

**p.m. eastbound**

	Qtr.	1	2	3	4+	Van	Public Transit	Other Bus	2 Axle	3+ Axle	Motor- cycle	TOTAL OBS.	ACO	Counts
Off ramp	Q2/94	240	37	7	2	0	6	0	4	0	1	297	1.20	5
	Q3/94	196	38	10	9	0	6	1	12	0	1	273	1.34	5
	Q4/94	No observations											- -	

**SITE #56. I-90 - Bellevue Way**

- ACO on/ramp WB-am
- ACO off/ramp EB-pm

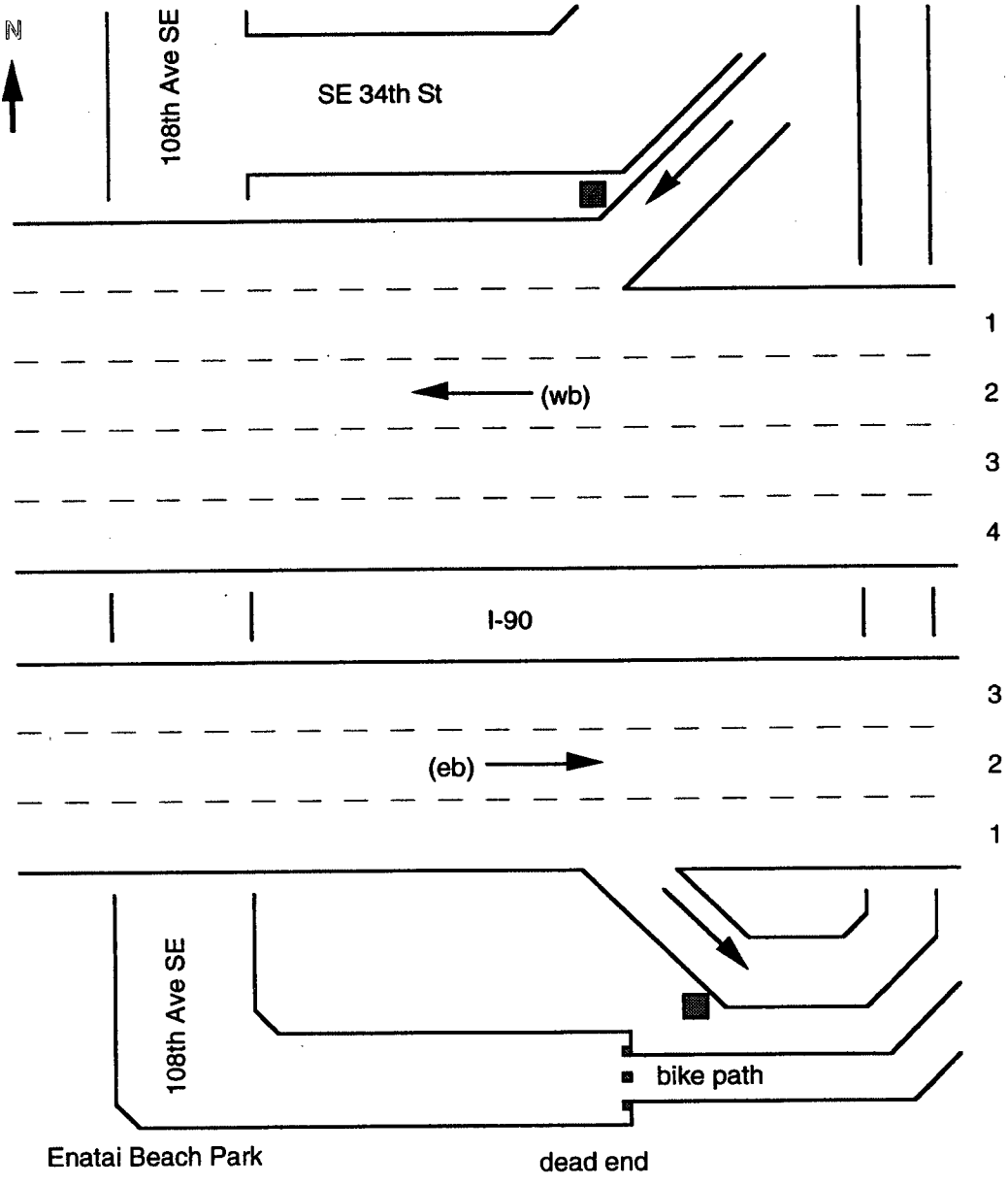

## I-90 - Bellevue Way

### a.m. westbound

	Qtr.	1	2	3	4+	Van	Public Transit	Other Bus	2 Axle	3+ Axle	Motor- cycle	TOTAL OBS.	ACO	Counts
On ramp	Q3/92	2388	285	39	9	3	64	1	43	18	5	2855	1.14	13
	Q4/92	1114	106	12	4	0	28	0	22	4	4	1294	1.12	5
	Q1/93	2689	266	27	7	3	76	2	32	15	1	3118	1.11	14
	Q2/93	1464	202	24	4	0	46	0	20	9	5	1774	1.16	8
	Q3/93	1504	198	13	6	0	49	0	25	13	6	1814	1.14	9
	Q4/93	338	30	4	0	0	10	1	7	0	0	390	1.10	2
	Q1/94	2072	146	6	2	0	20	2	36	2	0	2286	1.07	10
	Q2/94	761	103	6	5	0	23	1	16	4	1	920	1.15	4
	Q3/94	1023	98	10	2	3	6	0	13	11	1	1167	1.11	6
	Q4/94	761	84	1	0	0	7	1	13	9	0	876	1.10	5
	Q1/95	807	53	3	2	0	7	1	14	7	0	894	1.08	4
	Q2/95	1087	60	9	1	0	8	2	4	14	2	1187	1.07	6
	Q3/95	No observations											--	

86

### p.m. eastbound

	Qtr.	1	2	3	4+	Van	Public Transit	Other Bus	2 Axle	3+ Axle	Motor- cycle	TOTAL OBS.	ACO	Counts
Off ramp	Q3/92	4617	1117	227	95	5	76	2	37	18	19	6213	1.31	16
	Q4/92	1577	286	40	9	2	27	1	12	4	3	1961	1.21	6
	Q1/93	4838	839	90	41	2	41	3	27	12	5	5898	1.20	17
	Q2/93	1232	204	29	12	1	3	1	14	0	2	1499	1.20	4
	Q3/93	No observations											--	
	Q4/93	3162	396	43	22	3	10	1	26	9	0	3672	1.15	10
	Q1/94	2946	454	73	36	1	12	2	25	7	2	3558	1.20	11
	Q2/94	1540	322	49	10	1	25	5	17	9	6	1984	1.24	6
	Q3/94	3124	746	71	37	12	35	0	36	1	6	4068	1.25	11
	Q4/94	2115	292	33	18	1	9	2	18	8	1	2497	1.17	7
	Q1/95	1351	186	26	12	1	6	3	11	5	2	1603	1.18	5
	Q2/95	1383	168	20	15	1	6	2	14	3	0	1612	1.16	5
	Q3/95	No observations											--	

98

**SITE #57. I-90 - Newport Way**

- ▲ ACO GP WB-am
- ▲ ACO GP EB-pm
- ▲ ACO HOV WB-am
- ▲ ACO HOV EB-pm
- ACO on/ramp WB-am
- ACO off/ramp EB-pm

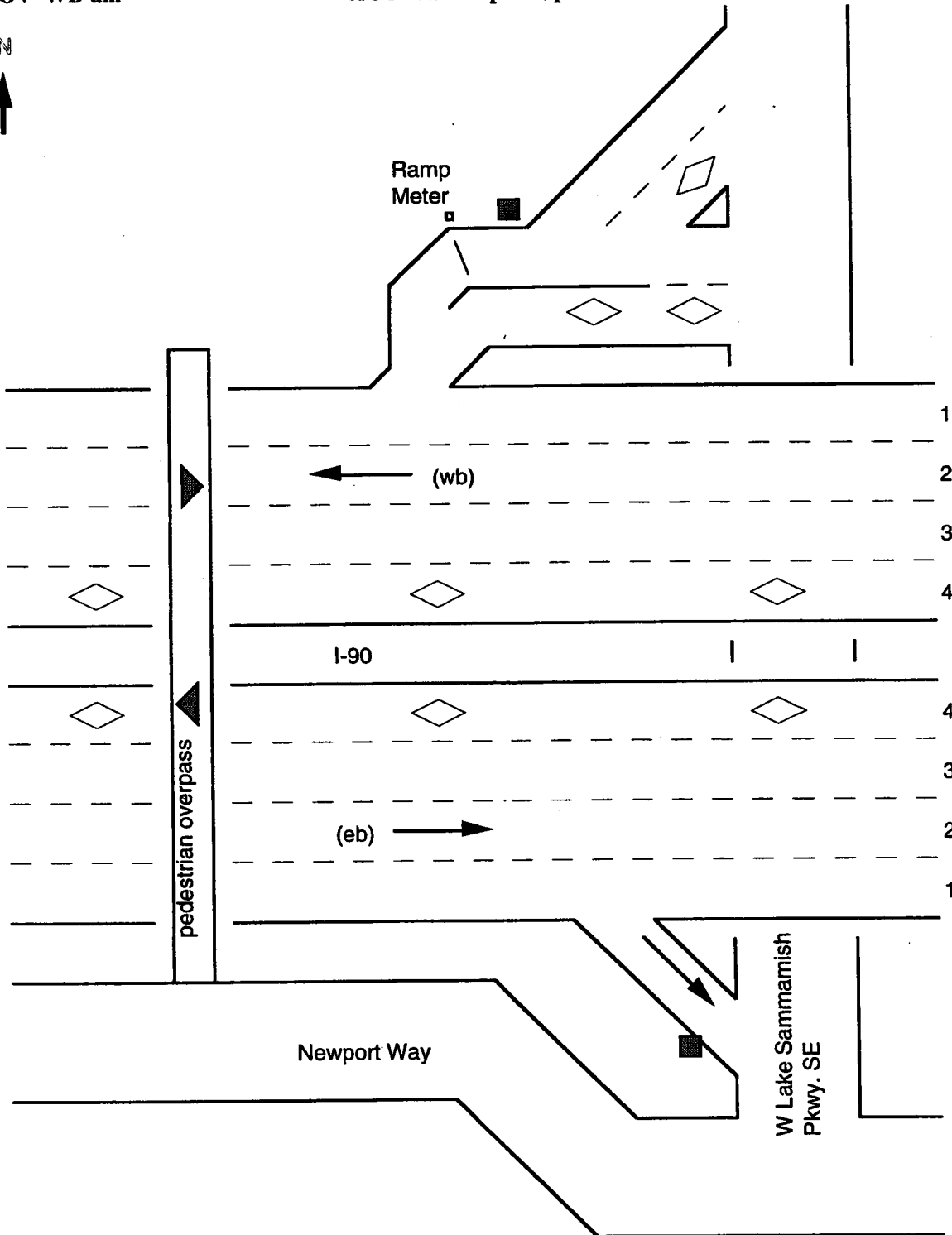

**Note:** Observations for this site started in the third quarter of 1993. In the westbound direction lane 4 was converted to an HOV lane in November 1993. Lane 4 in the eastbound direction was converted to an HOV Lane in November, 1994.

**I-90 Newport Way**

**a.m. westbound**

	Qtr.	1	2	3	4+	Van	Public Transit	Other Bus	2 Axle	3+ Axle	Motor- cycle	TOTAL ACO OBS.	Counts	
HOV	Q4/93 No observations												--	
1	Q1/94	2	31	11	0	0	0	0	0	0	0	44	2.20	1
	Q2/94	11	163	31	19	0	2	1	3	0	6	236	2.28	5
	Q3/94	26	448	44	10	8	5	1	2	0	27	571	2.08	5
	Q4/94	20	742	44	9	6	3	0	3	1	3	831	2.05	6
	Q1/95	25	870	71	13	14	5	2	2	2	15	1019	2.08	9
	Q2/95	12	502	31	9	14	5	2	0	0	20	595	2.07	9
	Q3/95	3	221	16	7	4	5	0	1	0	10	267	2.11	8
	No observations conducted Q4/95 - Q2/96												-	
	Q3/96	13	723	53	10	10	5	2	3	0	27	846	2.08	8
	No observations conducted Q4/96 - Q1/97												-	
	Q2/97	16	1062	48	5	23	12	11	10	0	21	1208	2.04	9
	Q3/97	17	1182	64	13	16	14	6	2	0	56	1370	2.06	9
	No observations conducted Q4/97 - Q1/98												-	
	Q2/98	38	1204	282	41	23	23	6	27	0	63	1701	2.21	13
														82
GP	Q3/93	14865	1529	128	65	15	22	17	282	592	88	17603	1.12	36
4*	Q4/93 No observations												--	
3	Q1/94	8050	664	45	9	0	10	9	159	214	7	9167	1.09	11
	Q2/94	5106	301	34	10	3	8	4	79	195	12	5752	1.07	16
	Q3/94	11938	961	65	30	7	15	6	234	431	56	13743	1.09	26
	Q4/94	2567	227	19	7	1	3	4	67	98	0	2993	1.10	6
	Q1/95	3074	164	11	2	3	2	2	32	103	7	3400	1.06	6
	Q2/95	2765	130	6	7	4	3	0	46	128	3	3092	1.06	7
	Q3/95	1119	71	2	1	1	1	1	35	116	6	1353	1.07	6
	No observations conducted Q4/95 - Q2/96												-	
	Q3/96	3677	187	17	2	1	2	4	44	95	6	4035	1.06	7
	No observations conducted Q4/96 - Q1/97												-	
	Q2/97	5183	269	22	15	7	3	0	41	140	7	5687	1.07	8
	Q3/97	6456	326	21	7	10	7	2	62	160	3	7054	1.06	9
	No observations conducted Q4/97 - Q1/98												-	
	Q2/98	7245	480	27	24	11	2	11	273	225	16	8314	1.08	12
														150

\* 4 lanes until Q1/94

**I-90 Newport Way**

**p.m. eastbound**

	Qtr.	1	2	3	4+	Van	Public Transit	Other Bus	2 Axle	3+ Axle	Motor- cycle	TOTAL OBS.	ACO	Counts
HOV	Q4/94	19	651	62	40	16	0	1	1	0	6	796	2.17	9
1	Q1/95	9	917	125	41	16	4	3	6	0	30	1151	2.19	10
	Q2/95	38	1073	93	38	18	4	2	3	1	22	1292	2.11	9
	Q3/95	19	1215	162	72	18	3	3	3	1	43	1539	2.21	7
	No observations conducted Q4/95 - Q2/96												-	
	Q3/96	11	996	89	44	8	2	0	12	1	57	1220	2.15	9
	No observations conducted Q4/96 - Q1/97												-	
	Q2/97	5	965	101	7	10	2	3	1	0	17	1111	2.10	6
	Q3/97	15	1106	195	49	7	5	1	1	0	50	1429	2.21	8
	No observations conducted Q4/97 - Q1/98												-	
	Q2/98	48	2675	431	126	41	8	11	64	2	120	3526	2.20	17
														75
	Q3/93	14667	3165	410	219	10	38	10	289	402	109	19317	1.25	34
GP	Q4/93	No observations												--
4*	Q1/94	3779	714	133	46	4	7	6	63	148	6	4906	1.24	9
3	Q2/94	3665	919	149	83	9	4	3	80	77	12	5001	1.31	8
	Q3/94	5985	1380	266	145	21	11	3	116	240	38	8205	1.31	16
	Q4/94	4037	639	61	25	4	10	6	59	121	4	4966	1.18	7
	Q1/95	4378	620	77	43	3	8	1	79	126	13	5348	1.18	7
	Q2/95	3501	413	35	13	7	2	4	43	80	2	4100	1.13	7
	Q3/95	4895	825	151	47	16	10	0	84	139	9	6176	1.22	9
	No observations conducted Q4/95 - Q2/96												-	
	Q3/96	3365	388	54	30	4	4	3	56	115	15	4034	1.15	7
	No observations conducted Q4/96 - Q1/97												-	
	Q2/97	2599	346	13	13	2	0	1	19	61	1	3055	1.14	4
	Q3/97	6569	939	149	79	33	12	3	79	138	27	8028	1.19	12
	No observations conducted Q4/97 - Q1/98												-	
	Q2/98	No observations conducted Q4/97 - Q1/98												-
	Q2/98	7756	1271	120	40	15	5	5	192	234	33	9691	1.18	14
														134

\* 4 lanes until Q1/94

## I-90 Newport Way

### a.m. westbound

	Qtr.	1	2	3	4+	Van	Public Transit	Other Bus	2 Axle	3+ Axle	Motor- cycle	TOTAL OBS.	ACO	Counts	
On ramp	Q3/93	3099	351	57	28	0	1	1	22	17	18	3594	1.16	14	
	Q4/93	No observations											--		
	Q1/94	534	79	8	6	0	0	0	2	2	1	632	1.18	3	
	Q2/94	1586	178	8	3	1	0	0	7	14	16	1813	1.11	9	
	Q3/94	1208	161	17	9	2	0	0	7	3	4	1411	1.16	5	
	Q4/94	1425	205	19	12	1	0	2	7	8	2	1681	1.17	8	
	Q1/95	1567	239	17	7	0	0	0	7	6	0	1843	1.16	6	
	Q2/95	2292	236	15	20	4	1	11	8	11	3	2601	1.13	10	
	Q3/95	No observations											--		

55

### p.m. eastbound

	Qtr.	1	2	3	4+	Van	Public Transit	Other Bus	2 Axle	3+ Axle	Motor- cycle	TOTAL OBS.	ACO	Counts	
Off ramp	Q3/93	2039	329	49	18	0	0	1	39	7	19	2501	1.20	22	
	Q4/93	No observations											--		
	Q1/94	495	82	8	2	0	0	0	1	3	1	592	1.18	5	
	Q2/94	1466	243	27	12	1	0	1	11	4	12	1777	1.19	10	
	Q3/94	2904	452	75	34	8	1	2	27	11	10	3524	1.21	14	
	Q4/94	1444	129	9	3	3	0	0	6	3	2	1599	1.10	9	
	Q1/95	1239	161	20	8	2	0	0	8	2	3	1443	1.16	5	
	Q2/95	1894	326	24	13	4	3	1	14	8	2	2289	1.18	11	
	Q3/95	No observations											--		

76



**SITE #58. I-90 - Front St**

- ACO on/ramp WB-am
- ACO off/ramp EB-pm

**Ending Q3/94**

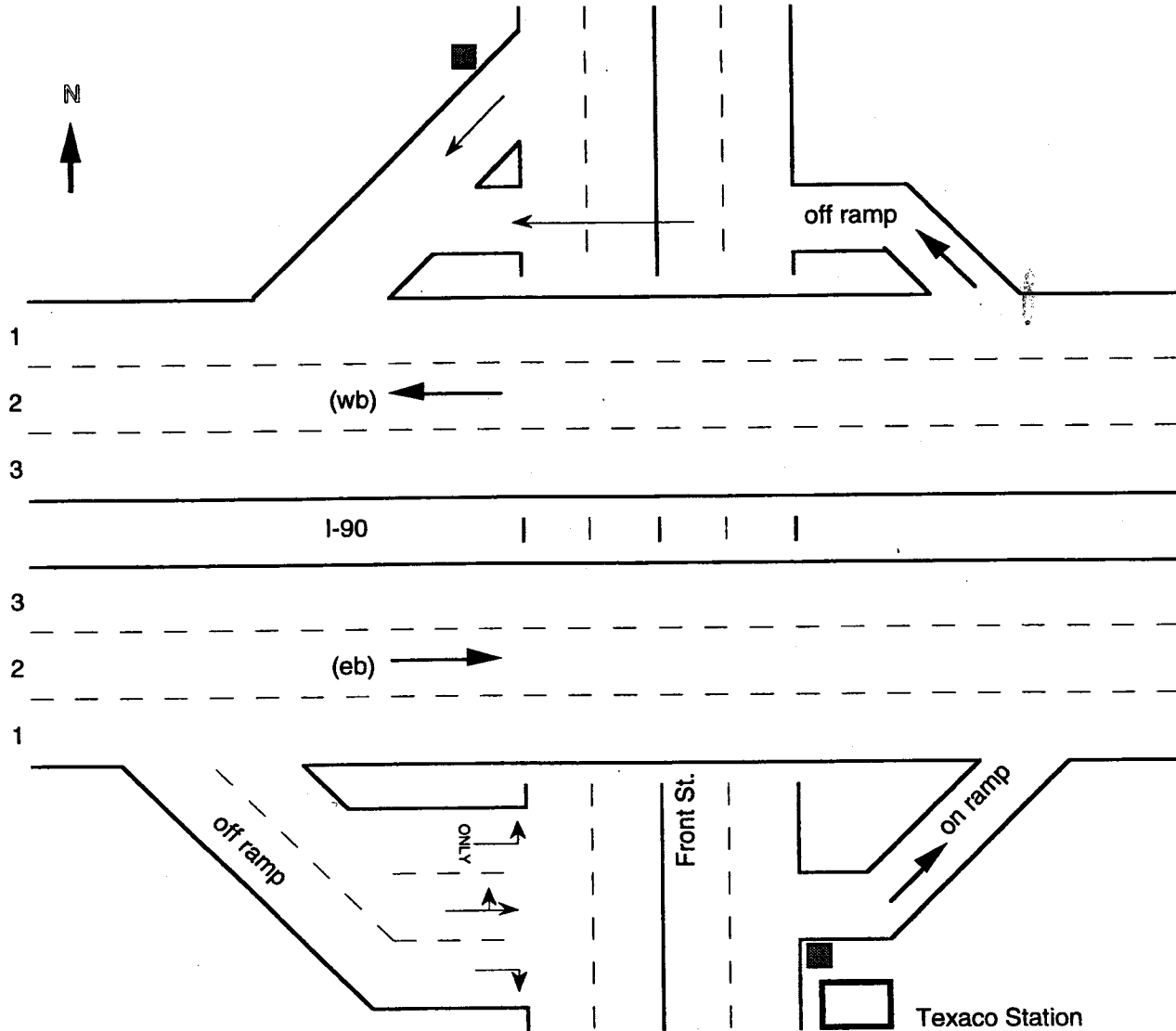

**Note:** This site was observed by special request for baseline data before WB HOV ramp conversion.

**a.m. westbound**

	Qtr.	1	2	3	4+	Van	Public Transit	Other Bus	2 Axle	3+ Axle	Motor- cycle	TOTAL OBS.	ACO Counts
Off ramp	Q3/93	10965	930	90	45	7	1	13	122	204	35	12412	1.10
	Q4/93	No observations											
	Q1/94	No observations											
	Q2/94	No observations											
	Q3/94	No observations											

**I-90 - Front St**

**p.m. eastbound**

	Qtr.	1	2	3	4+	Van	Public Transit	Other Bus	2 Axle	3+ Axle	Motor- cycle	TOTAL OBS.	ACO	Counts
Off ramp	Q3/93	10558	1813	282	178	7	1	6	191	170	89	13295	1.23	20
	Q4/93	No observations												
	Q1/94	No observations												
	Q2/94	No observations												
	Q3/94	No observations												

20

**SITE #58. I-90 - Front St**

**Beginning Q4/94**

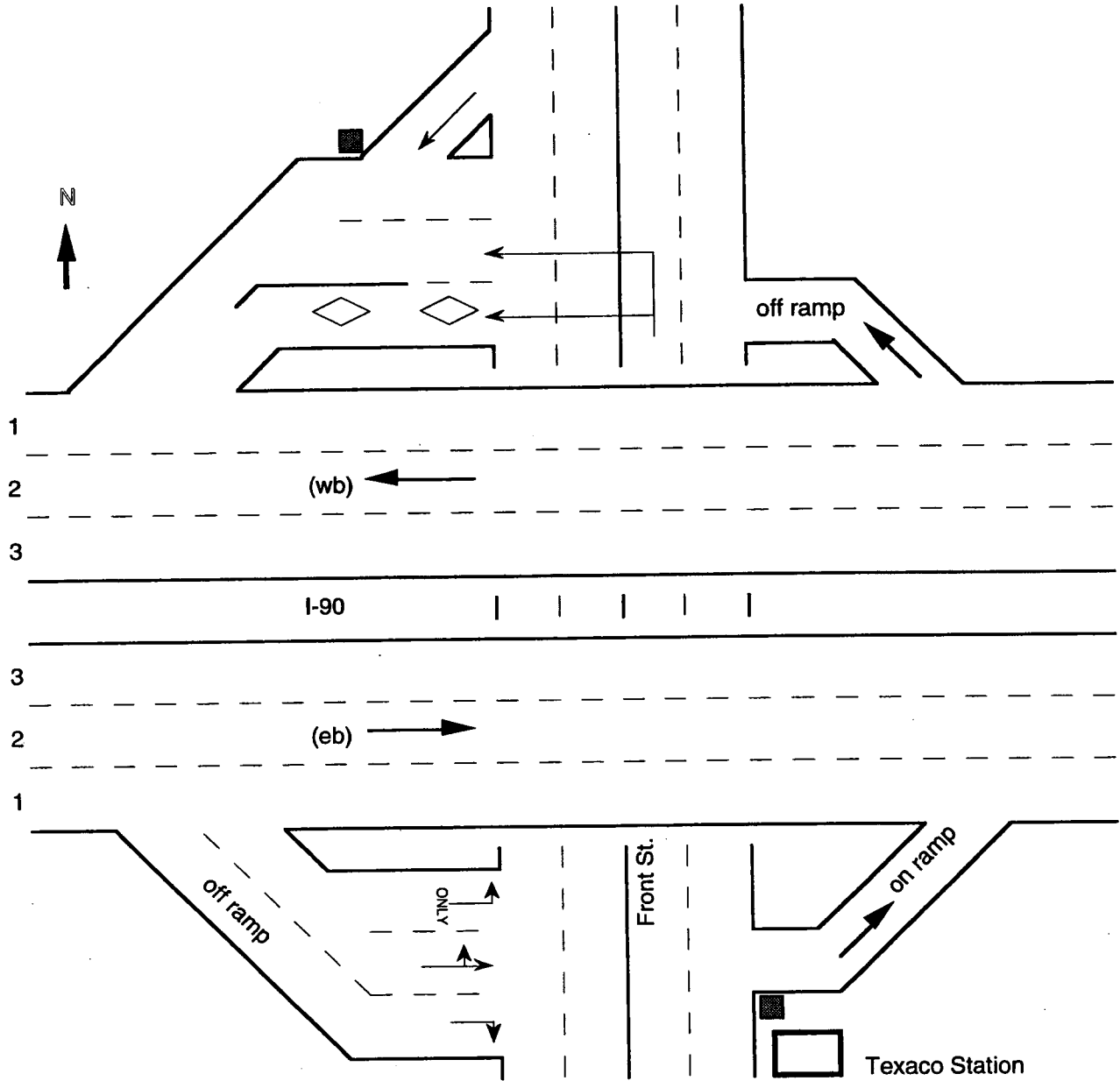

**I-90 - Front St**

**a.m. westbound**

	Qtr.	1	2	3	4+	Van	Public Transit	Other Bus	2 Axle	3+ Axle	Motor- cycle	TOTAL OBS.	ACO	Counts
Off ramp	Q4/94	2032	117	5	1	2	2	2	29	57	1	2248	1.06	4
	Q1/95	2222	180	8	1	2	0	4	15	50	3	2493	1.09	3
	Q2/95	3564	222	16	5	2	0	11	56	103	11	3990	1.07	10
	Q3/95	No observations											--	
														17

**p.m. eastbound**

	Qtr.	1	2	3	4+	Van	Public Transit	Other Bus	2 Axle	3+ Axle	Motor- cycle	TOTAL OBS.	ACO	Counts
Off ramp	Q4/94	4808	835	109	61	6	3	2	73	63	4	5964	1.21	10
	Q1/95	3173	505	69	20	9	1	3	22	26	1	3829	1.19	6
	Q2/95	2334	369	45	14	4	3	1	44	40	6	2860	1.18	5
	Q3/95	No observations											--	
														21

**Vehicle Occupancy (ACO) Sites  
I-405 (Corridor #6)**

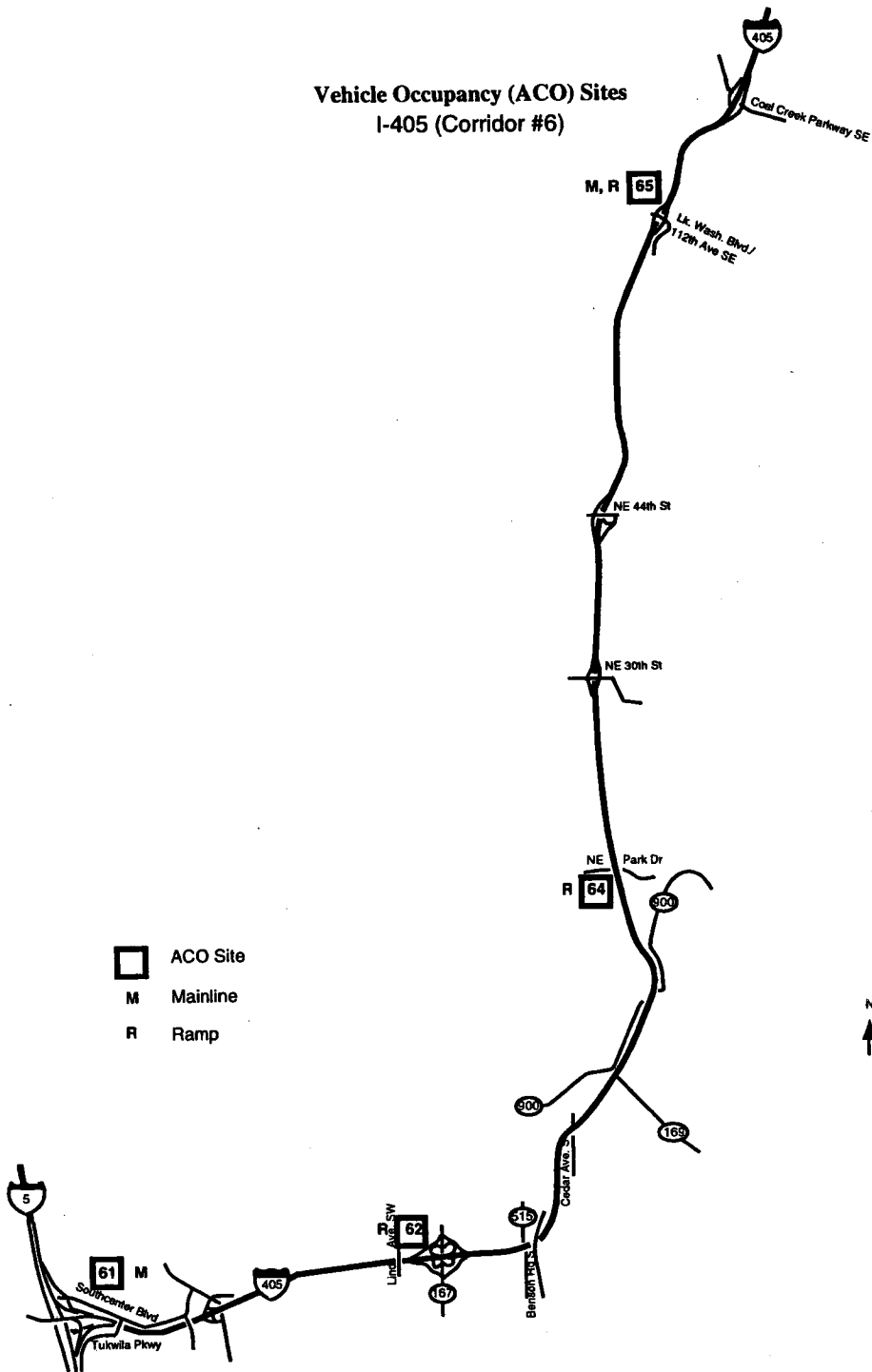

**SITE #61. I-405 SOUTH - Tukwila Parkway**

▲ ACO mainline NB & SB-am & pm

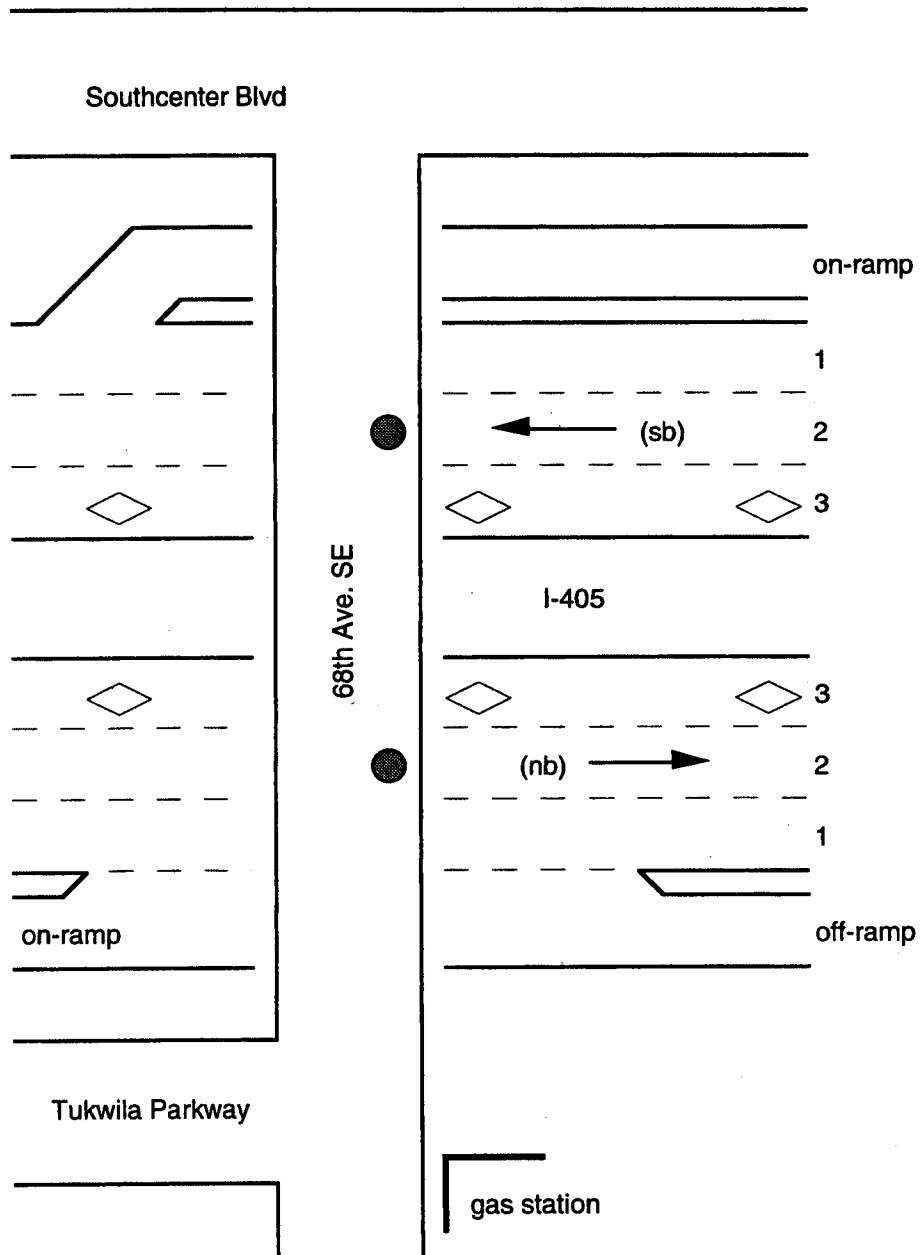

**Note:** The freeway here is called I-405 North and South, but you will actually be looking east or west when you observe traffic. Northbound I-405 goes east toward Bellevue, and southbound I-405 goes west toward the airport. Be sure to indicate north or south in the program.

There is a sidewalk on only the east side of Tukwila Parkway. In order to count northbound I-405 traffic on the mainline at this location, you have to cross the street, step over the jersey barrier, and sit on the very narrow strip of dirt at the very edge of the overpass. You will be looking down and to the side at the mainline traffic. Be sure to wear a vest in this location.

**I-405 South - Tukwila Parkway**

a.m. northbound		Qtr.	1	2	3	4+	Van	Public Transit	Other Bus	2 Axle	3+ Axle	Motor-cycle	TOTAL OBS.	ACO	Counts	
HOV lanes 1	Q3/92	No observations											--			
	Q4/92	2	19	1	0	0	0	0	0	0	0	0	22	1.95	1	
	Q1/93	17	73	11	6	0	0	0	0	2	0	16	115	2.07	2	
	Q2/93	12	134	23	7	0	1	1	1	0	0	4	183	2.15	2	
	Q3/93	507	223	22	14	2	5	2	14	16	28	833	1.41*	7		
	Q4/93	18	129	23	12	1	0	5	4	0	8	200	2.17	3		
	Q1/94	13	180	21	6	2	1	3	2	0	6	234	2.10	3		
	Q2/94	19	147	24	12	1	0	3	3	0	4	213	2.16	4		
	Q3/94	34	325	39	16	4	6	5	1	0	35	465	2.10	6		
	Q4/94	46	378	38	0	6	9	0	2	0	12	491	1.98*	6		
	Q1/95	7	347	44	8	2	3	4	10	0	13	438	2.13	9		
	Q2/95	43	649	47	5	19	14	3	2	0	17	799	2.02	13		
	Q3/95	6	178	16	6	3	7	1	2	0	8	227	2.11	9		
	No observations conducted Q4/95 - Q2/96													-		
	Q3/96	8	737	47	11	16	6	3	2	0	30	860	2.08	9		
	No observations conducted Q4/96 - Q1/97													-		
	Q2/97	24	932	69	18	31	19	4	0	0	30	1127	2.08	8		
	Q3/97	14	1226	79	25	44	19	9	2	0	61	1476	2.09	11		
	No observations conducted Q4/97 - Q1/98													-		
	Q2/98	60	1669	173	50	35	28	28	77	4	75	2199	2.11	14		
<b>107</b>																
GP lanes 2	Q3/92	No observations											-			
	Q4/92	593	25	1	1	0	0	4	14	31	0	669	1.05	1		
	Q1/93	2844	176	6	0	2	2	1	78	94	4	3207	1.06	5		
	Q2/93	2419	172	20	2	1	8	1	76	103	1	2803	1.08	4		
	Q3/93	5243	370	27	10	2	7	17	219	291	10	6196	1.08	9		
	Q4/93	3211	287	28	7	0	1	14	184	113	12	3857	1.10	7		
	Q1/94	5922	441	32	6	3	5	10	219	214	2	6854	1.08	10		
	Q2/94	4312	301	41	12	7	7	14	181	359	11	5245	1.09	10		
	Q3/94	4922	408	50	16	8	13	18	180	364	11	5990	1.10	12		
	Q4/94	2150	101	9	4	6	0	7	99	153	4	2533	1.06	4		
	Q1/95	1991	131	9	1	6	3	10	93	181	1	2426	1.07	6		
	Q2/95	4469	231	13	17	12	8	4	115	288	3	5160	1.07	13		
	Q3/95	1392	68	4	2	1	4	4	57	140	4	1676	1.06	7		
	No observations conducted Q4/95 - Q2/96													-		
	Q3/96	3156	132	15	6	5	7	0	67	197	7	3592	1.05	6		
	No observations conducted Q4/96 - Q1/97													-		
	Q2/97	3366	187	16	4	10	6	3	90	216	4	3902	1.06	7		
	Q3/97	4398	191	18	10	9	4	4	132	341	2	5109	1.06	10		
	No observations conducted Q4/97 - Q1/98													-		
	Q2/98	5637	418	37	13	8	3	21	236	437	11	6821	1.09	11		
<b>122</b>																

**I-405 South - Tukwila Parkway**

**p.m. northbound**

	Qtr.	1	2	3	4+	Van	Public Transit	Other Bus	2 Axle	3+ Axle	Motor- cycle	TOTAL ACO OBS.	Counts	
HOV lanes	Q3/92	No observations											--	
	Q4/92	No observations											--	
1	Q1/93	No observations											--	
	Q2/93	10	428	43	33	2	1	0	9	0	12	538	2.21	2
	Q3/93	124	205	31	12	2	1	2	2	0	4	383	1.82*	2
	Q4/93	6	505	13	12	0	1	5	4	1	7	554	2.06	2
	Q1/94	28	549	59	27	0	1	7	6	0	10	687	2.14	3
	Q2/94	49	649	103	25	9	0	0	0	0	7	842	2.13	3
	Q3/94	89	1478	140	84	15	3	6	15	0	70	1900	2.13	8
	Q4/94	69	1243	92	41	24	3	2	7	0	24	1505	2.08	6
	Q1/95	18	1199	101	39	28	16	5	7	1	8	1422	2.12	7
	Q2/95	61	2038	266	87	20	5	7	17	1	33	2535	2.16	9
	Q3/95	119	2640	257	56	46	6	15	14	0	62	3215	2.09	8
	No observations conducted Q4/95 - Q2/96												--	
	Q3/96	59	1971	319	124	27	3	6	8	0	54	2571	2.22	11
	No observations conducted Q4/96 - Q1/97												--	
	Q2/97	66	2497	314	146	40	6	1	14	0	62	3146	2.19	9
	Q3/97	69	1079	186	98	70	6	14	21	1	25	1569	2.23	8
	No observations conducted Q4/97 - Q1/98												--	
	Q2/98	190	4436	602	179	48	7	53	106	0	84	5705	2.15	17
														95

\* Observers consistently note higher than normal number of violators on this HOV lane.



**I-405 South - Tukwila Parkway**

p.m.	northbound											TOTAL OBS.	ACO	Counts	
	Qtr.	1	2	3	4+	Van	Public Transit	Other Bus	2 Axle	3+ Axle	Motor- cycle				
GP lanes	Q3/92	1722	219	31	9	0	0	1	30	59	3	2074	1.16	3	
	Q4/92	No observations											--		
2	Q1/93	No observations											--		
	Q2/93	5982	305	48	17	1	0	5	120	180	8	6666	1.07	10	
	Q3/93	1975	255	20	8	0	0	3	49	65	4	2379	1.14	6	
	Q4/93	4717	452	3	65	0	0	6	125	88	3	5492	1.14	7	
	Q1/94	6213	562	33	24	0	1	5	163	134	2	7137	1.10	11	
	Q2/94	4205	448	66	29	6	2	1	73	109	0	4939	1.14	7	
	Q3/94	8604	785	115	91	16	1	1	199	261	15	10088	1.14	15	
	Q4/94	4155	1210	161	38	18	1	5	80	84	41	5756	1.30	11	
	Q1/95	4275	487	47	14	8	5	5	96	113	0	5050	1.13	6	
	Q2/95	3498	287	33	15	1	1	1	46	96	2	3980	1.10	6	
	Q3/95	4773	370	78	24	16	1	7	122	148	4	5543	1.11	9	
	No observations conducted Q4/95 - Q2/96											--			
	Q3/96	4451	584	95	44	6	3	5	118	179	8	5493	1.18	10	
	No observations conducted Q4/96 - Q1/97											--			
	Q2/97	4946	576	63	33	9	1	2	86	110	3	5829	1.14	9	
	Q3/97	3152	525	50	49	13	2	2	56	154	4	4007	1.21	8	
	No observations conducted Q4/97 - Q1/98											--			
	Q2/98	9452	744	87	39	7	6	17	296	261	7	10916	1.10	17	

**I-405 South - Tukwila Parkway**

**a.m. southbound**

	Qtr.	1	2	3	4+	Van	Public Transit	Other Bus	2 Axle	3+ Axle	Motor- cycle	TOTAL OBS.	ACO	Counts	
HOV lanes 1	Q3/92	39	347	74	16	3	0	12	2	1	23	517	2.15	5	
	Q4/92	No observations											--		
	Q1/93	No observations											--		
	Q2/93	4	50	23	3	0	0	0	0	0	1	81	2.32	1	
	Q3/93	662	733	150	69	3	0	11	15	9	43	1695	1.78*	7	
	Q4/93	3	82	15	6	0	0	3	4	3	1	114	2.24	1	
	Q1/94	21	309	63	9	2	0	2	3	0	1	410	2.15	3	
	Q2/94	22	671	107	18	9	1	5	1	0	15	849	2.15	6	
	Q3/94	17	578	114	37	13	0	1	5	0	20	785	2.24	6	
	Q4/94	20	685	56	9	6	0	3	4	0	10	793	2.07	6	
	Q1/95	24	820	68	7	12	0	3	1	0	23	958	2.06	7	
	Q2/95	47	997	67	17	22	4	2	8	0	9	1173	2.05	11	
	Q3/95	13	318	33	16	3	1	17	2	0	18	421	2.15	9	
	No observations conducted Q4/95 - Q2/96												--		
	Q3/96	7	691	44	14	18	0	1	1	0	19	795	2.09	8	
	No observations conducted Q4/96 - Q1/97												--		
	Q2/97	6	1233	133	30	23	0	15	10	0	52	1503	2.14	9	
	Q3/97	3	1613	104	19	40	2	2	2	0	49	1834	2.08	11	
	No observations conducted Q4/97 - Q1/98												--		
	Q2/98	171	2115	206	40	25	3	40	32	4	78	2714	2.05	14	
	<b>104</b>														
	GP lanes 2	Q3/92	4935	428	52	13	2	1	1	112	212	6	5762	1.11	8
		Q4/92	No observations											--	
Q1/93		No observations											--		
Q2/93		1444	148	16	10	1	0	0	29	46	3	1697	1.13	2	
Q3/93		11005	1408	227	134	4	0	7	434	530	25	13774	1.18	16	
Q4/93		3133	260	26	10	1	0	6	86	123	1	3646	1.10	6	
Q1/94		6255	588	69	12	5	1	9	219	175	6	7339	1.11	11	
Q2/94		9349	853	118	24	8	0	13	195	426	6	10992	1.11	15	
Q3/94		7237	891	127	25	11	0	6	212	311	5	8825	1.15	16	
Q4/94		2579	255	16	13	2	0	4	89	125	2	3085	1.11	4	
Q1/95		3637	331	12	3	5	0	2	59	140	1	4190	1.09	6	
Q2/95		4753	289	12	2	6	1	6	120	220	9	5418	1.06	9	
Q3/95		1440	61	4	3	5	2	3	44	120	20	1702	1.05	6	
No observations conducted Q4/95 - Q2/96												--			
Q3/96		3375	240	40	15	10	1	6	105	239	6	4037	1.10	7	
No observations conducted Q4/96 - Q1/97												--			
Q2/97		4737	393	25	17	20	0	7	175	370	3	5747	1.10	9	
Q3/97		4507	205	18	6	8	0	4	95	292	3	5138	1.05	8	
No observations conducted Q4/97 - Q1/98												--			
Q2/98		6503	580	41	24	4	2	17	187	362	44	7764	1.10	10	

**I-405 South - Tukwila Parkway**

p.m.	southbound											TOTAL	ACO	Counts	
	Qtr.	1	2	3	4+	Van	Public Transit	Other Bus	2 Axle	3+ Axle	Motor- cycle				OBS.
HOV lanes 1	Q3/92	3	53	15	2	0	0	1	1	0	5	80	2.22	1	
	Q4/92	5	1	67	0	0	0	0	0	0	0	73	2.85	1	
	Q1/93	8	54	14	3	0	1	0	0	0	1	81	2.16	1	
	Q2/93	9	234	55	22	2	2	3	4	0	9	341	2.30	4	
	Q3/93	665	214	11	1	0	2	2	2	1	3	901	1.27*	2	
	Q4/93	21	188	17	4	2	1	0	5	0	4	242	2.02	3	
	Q1/94	23	280	69	22	8	0	0	2	0	8	412	2.24	4	
	Q2/94	17	367	58	19	9	4	3	1	0	8	486	2.18	5	
	Q3/94	105	867	94	30	20	9	2	12	0	5	1189	2.05	7	
	Q4/94	73	725	72	31	21	5	2	15	1	15	960	2.07	7	
	Q1/95	18	1199	101	39	28	16	5	7	1	8	1422	2.12	8	
	Q2/95	75	1144	114	47	10	10	4	9	1	44	1458	2.10	9	
	Q3/95	32	2577	105	34	55	16	6	13	0	43	2881	2.05	9	
	No observations conducted Q4/95 - Q2/96												-		
	Q3/96	153	2965	308	77	46	15	4	17	2	60	3647	2.09	12	
	No observations conducted Q4/96 - Q1/97												-		
	Q2/97	49	1625	208	30	33	11	0	5	0	37	1998	2.12	10	
	Q3/97	241	2547	347	98	43	8	5	30	2	37	3358	2.10	8	
No observations conducted Q4/97 - Q1/98												-			
Q2/98	136	2515	285	65	32	16	9	41	0	41	3140	2.10	15		

106

\* Observers consistently note higher than normal number of violators on these HOV lane.

**I-405 South - Tukwila Parkway**

<b>p.m. southbound</b>		Qtr.	1	2	3	4+	Van	Public Transit	Other Bus	2 Axle	3+ Axle	Motor- cycle	TOTAL OBS.	ACO	Counts
GP lanes 2	Mar-92	1434	382	32	14	0	1	4	27	55	3	1952	1.26	4	
	Apr-92	1385	245	6	0	0	3	0	18	35	5	1697	1.16	3	
	Jan-93	1396	336	23	6	1	1	3	25	45	0	1836	1.23	3	
	Feb-93	6338	1477	194	48	10	6	7	181	157	17	8435	1.25	11	
	Q3/93	4594	1319	83	12	3	2	3	103	126	26	6271	1.25	9	
	Q4/93	3095	572	46	10	4	3	2	97	67	6	3902	1.19	6	
	Q1/94	4820	1096	168	40	19	3	9	110	112	7	6384	1.25	9	
	Q2/94	6858	1302	139	63	28	9	8	161	164	7	8739	1.21	14	
	Q3/94	7125	1504	125	32	10	4	7	234	213	23	9277	1.21	14	
	Q4/94	2372	441	16	11	3	1	3	88	96	3	3034	1.18	4	
	Q1/95	4275	487	47	14	8	5	5	96	113	0	5050	1.13	9	
	Q2/95	3139	600	16	17	1	1	4	68	83	8	3937	1.18	5	
	Q3/95	4727	435	41	9	9	5	2	158	165	5	5556	1.10	8	
	No observations conducted Q4/95 - Q2/96												-		
	Q3/96	3624	390	45	22	3	2	3	78	122	17	4306	1.13	10	
	No observations conducted Q4/96 - Q1/97												-		
	Q2/97	2559	439	17	24	9	4	0	57	69	12	3190	1.18	6	
	Q3/97	2825	351	23	12	2	0	1	52	88	2	3356	1.14	8	
	No observations conducted Q4/97 - Q1/98												-		
	Q2/98	7197	1371	132	52	17	7	18	224	189	10	9217	1.21	15	

**SITE #62. I-405 SOUTH - SR 167/Rainier Avenue South**

- ACO on/ramp NB-am & pm
- ACO off/ramp SB-am & pm

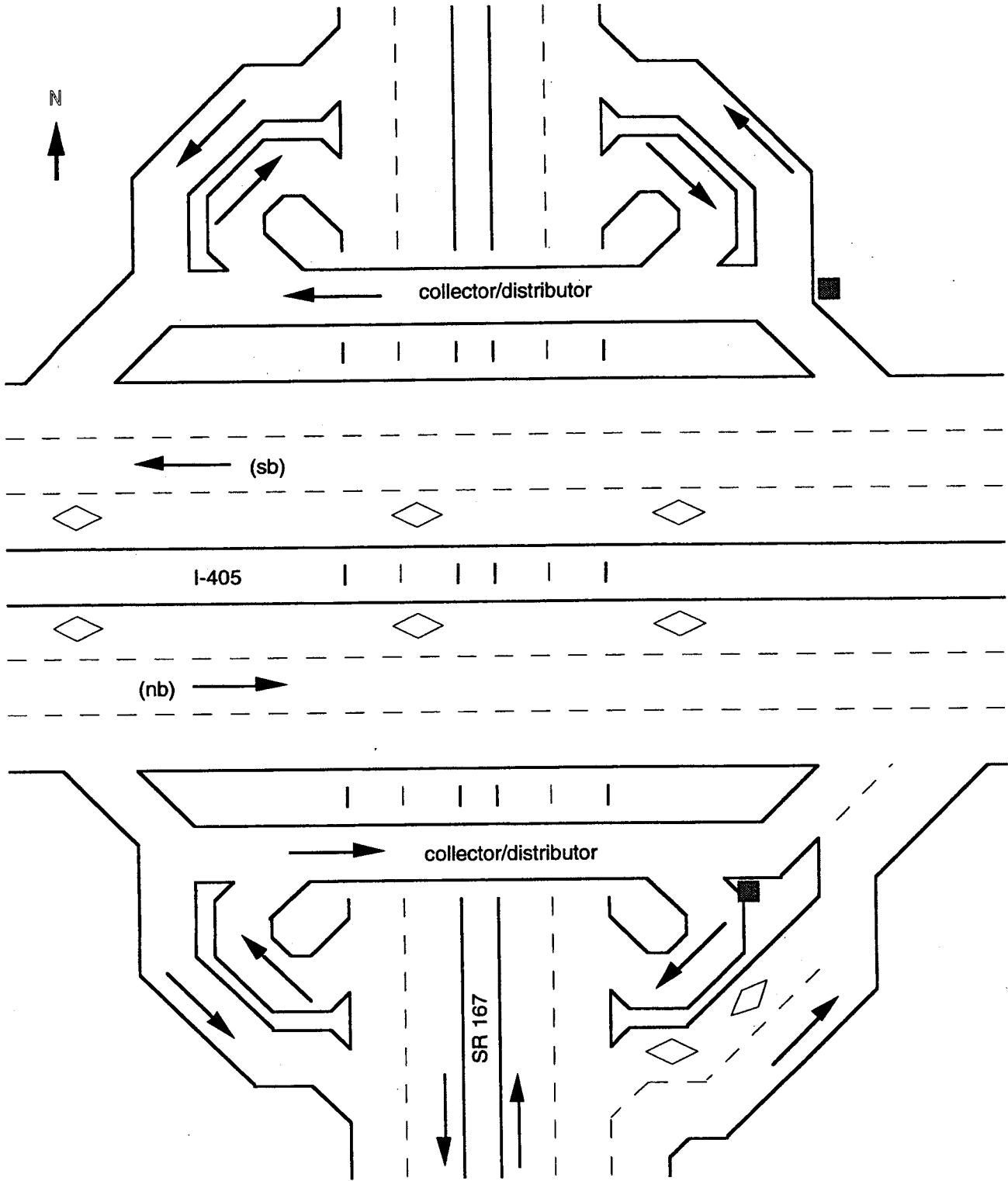

**Note:** The on/ramp northbound from SR 167 to I-405 is very busy, and traffic travels at near-freeway speeds most of the time. The off/ramp southbound is just as busy, but traffic may not be traveling quite as fast. It is very important that you wear a vest in each of these locations, and stay protected as much as possible from oncoming traffic.

Since these are split ramps in all directions, you will need to determine in advance and be quite clear about exactly which ramp in which direction you are to observe.

**a.m. northbound**

	Qtr.	1	2	3	4+	Van	Public Transit	Other Bus	2 Axle	3+ Axle	Motor- cycle	TOTAL OBS.	ACO	Counts	
On ramp	Q3/92	1155	125	10	1	3	2	0	58	149	8	1511	1.11	3	
	Q4/92	6449	740	69	15	11	14	5	524	705	6	8538	1.13	15	
	Q1/93	229	35	2	1	3	1	0	32	43	0	346	1.16	5	
	Q2/93	No observations											--		
	Q3/93	1419	114	10	3	4	2	1	78	140	9	1780	1.09	6	
	Q4/93	1262	148	20	12	0	0	1	106	166	2	1717	1.16	3	
	Q1/94	2922	332	33	6	1	0	3	306	243	3	3849	1.13	6	
	Q2/94	4212	575	79	21	15	0	5	268	456	27	5658	1.16	9	
	Q3/94	1763	135	9	1	5	0	8	137	236	10	2304	1.08	5	
	Q4/94	695	62	4	4	3	0	1	82	122	0	973	1.11	5	
	Q1/95	476	39	12	0	0	0	0	49	67	1	644	1.12	3	
	Q2/95	2882	139	11	10	5	0	5	204	356	5	3617	1.06	6	
	Q3/95	No observations											--		

66

**p.m. northbound**

	Qtr.	1	2	3	4+	Van	Public Transit	Other Bus	2 Axle	3+ Axle	Motor- cycle	TOTAL L OBS.	ACO	Counts	
On ramp	Q3/92	1861	494	72	51	2	0	1	57	76	15	2629	1.32	5	
	Q4/92	No observations											--		
	Q1/93	3648	346	32	12	2	0	6	68	113	3	4230	1.11	8	
	Q2/93	No observations											--		
	Q3/93	No observations											--		
	Q4/93	1393	231	35	11	3	2	0	29	59	8	1771	1.20	4	
	Q1/94	2714	369	35	20	1	2	0	56	75	6	3278	1.16	5	
	Q2/94	2040	284	37	18	1	0	0	66	73	9	2528	1.17	4	
	Q3/94	4646	838	148	89	8	4	12	123	206	45	6119	1.25	10	
	Q4/94	3865	251	28	9	3	1	0	115	139	6	4417	1.08	9	
	Q1/95	3340	381	49	6	8	0	5	70	88	3	3950	1.13	5	
	Q2/95	2963	433	32	8	0	1	2	37	76	10	3562	1.15	4	
	Q3/95	No observations											--		

54

**I-405 South - SR 167/Rainier Avenue South**

**a.m. southbound**

	Qtr.	1	2	3	4+	Van	Public Transit	Other Bus	2 Axle	3+ Axle	Motor- cycle	TOTAL OBS.	ACO	Counts
Off ramp	Q3/92	4576	493	72	29	2	0	3	164	196	16	5551	1.14	7
	Q4/92	1204	75	6	1	0	0	4	42	65	1	1398	1.07	2
	Q1/93	No observations											--	
	Q2/93	No observations											--	
	Q3/93	2190	116	13	6	1	0	3	64	120	3	2516	1.07	8
	Q4/93	341	14	2	2	0	1	5	9	7	0	381	1.07	2
	Q1/94	1797	145	14	2	2	1	0	93	79	1	2134	1.09	3
	Q2/94	5301	364	42	10	4	0	5	184	367	42	6319	1.08	10
	Q3/94	1502	155	9	11	2	4	0	128	136	8	1955	1.12	5
	Q4/94	2890	233	10	3	0	1	4	112	182	0	3435	1.08	7
	Q1/95	1256	80	10	1	1	1	1	64	136	3	1553	1.08	3
	Q2/95	896	60	4	3	0	5	0	29	92	8	1097	1.08	5
	Q3/95	No observations											--	
														52

**p.m. southbound**

	Qtr.	1	2	3	4+	Van	Public Transit	Other Bus	2 Axle	3+ Axle	Motor- cycle	TOTAL OBS.	ACO	Counts
Off ramp	Q3/92	No observations											--	
	Q4/92	1389	157	20	5	5	1	1	40	84	5	1707	1.14	6
	Q1/93	1486	224	30	3	5	1	0	63	47	5	1864	1.17	3
	Q2/93	No observations											--	
	Q3/93	No observations											--	
	Q4/93	No observations											--	
	Q1/94	2715	52	70	14	21	4	1	120	146	5	3619	1.21	6
	Q2/94	1133	174	10	3	5	1	0	77	85	3	1491	1.15	2
	Q3/94	6763	1360	166	71	38	11	0	295	404	55	9163	1.23	13
	Q4/94	1564	220	19	7	16	3	1	55	91	5	1981	1.15	9
	Q1/95	1981	308	44	13	14	3	1	90	135	1	2590	1.19	4
	Q2/95	2812	685	63	26	20	2	1	158	144	12	3923	1.25	5
	Q3/95	No observations											--	
														48

**SITE #64. I-405 SOUTH - S Park Drive**

- ACO on/ramp NB & SB-am & pm
- ACO off/ramp NB & SB- am & pm

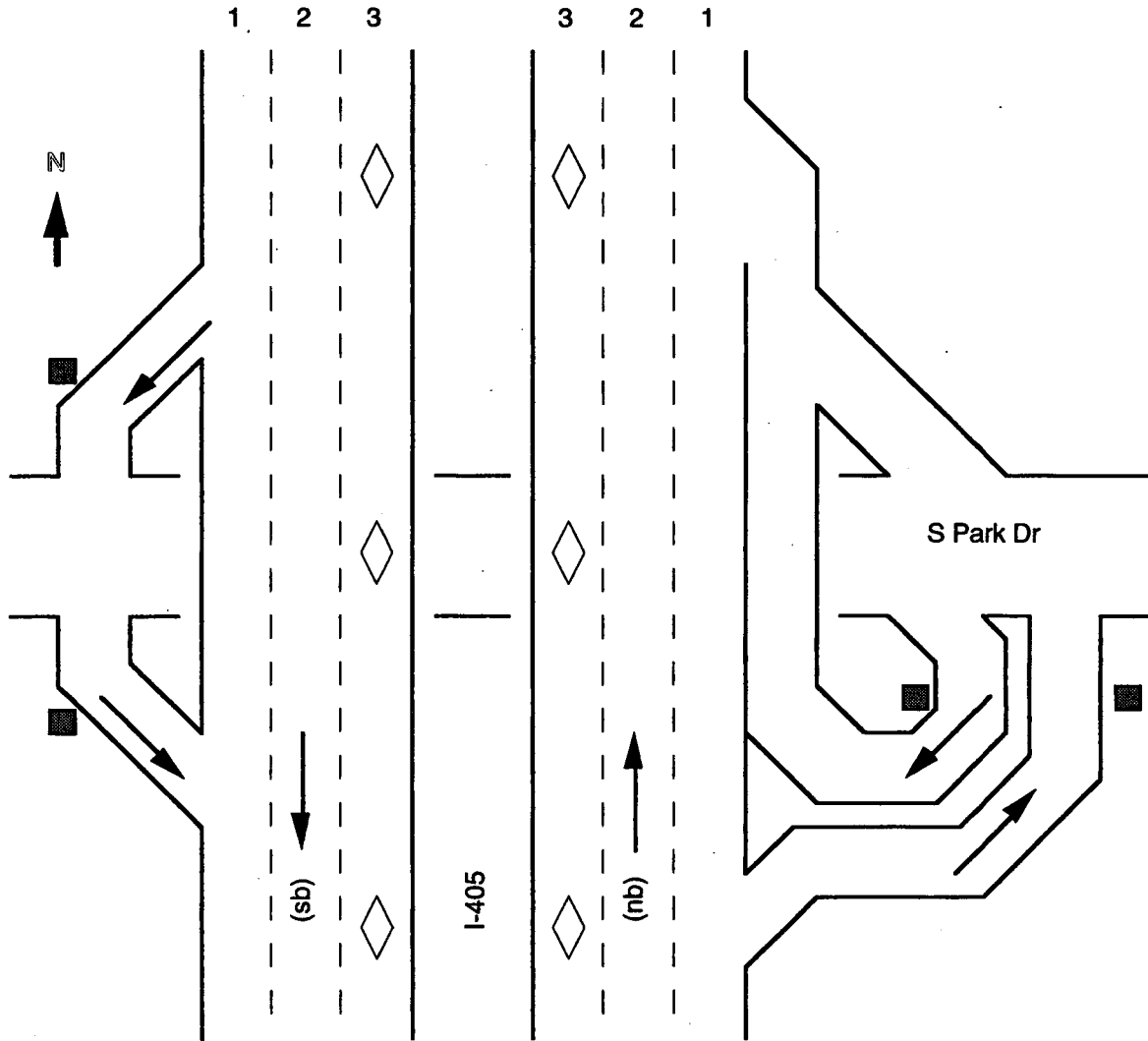

**Note:** There are a lot of Boeing plants and offices in this part of Renton, so traffic conforms to Boeing work schedules. If possible, it is a good idea to count these ramps from 5:30-8:30 in the morning, and from 2:00-5:00 or 5:30 in the afternoon. You will notice a significant drop in traffic after the shift change commute ends. HOV lanes switched from outside to inside Q1/97.



**I-405 South - S Park Drive**

**a.m. northbound**

	Qtr.	1	2	3	4+	Van	Public Transit	Other Bus	2 Axle	3+ Axle	Motor- cycle	TOTAL OBS.	ACO	Counts	
On ramp	Q3/92	425	63	8	4	2	10	0	8	1	2	523	1.18	4	
	Q4/92	No observations											-		
	Q1/93	No observations											-		
	Q2/93	401	67	9	5	1	12	0	17	6	2	520	1.21	5	
	Q3/93	No observations											-		
	Q4/93	495	76	12	6	1	9	2	10	9	0	620	1.20	4	
	Q1/94	430	57	8	1	2	13	5	19	7	0	542	1.15	7	
	Q2/94	745	124	9	5	7	25	5	25	19	3	967	1.18	9	
	Q3/94	380	77	8	2	2	15	2	13	5	1	505	1.21	4	
	Q4/94	702	112	8	6	5	19	1	15	28	0	896	1.18	7	
	Q1/95	209	30	7	2	1	7	1	9	13	3	282	1.20	3	
	Q2/95	307	48	3	2	2	10	2	4	8	1	387	1.17	3	
	Q3/95	No observations											-		

46

**p.m. northbound**

	Qtr.	1	2	3	4+	Van	Public Transit	Other Bus	2 Axle	3+ Axle	Motor- cycle	TOTAL OBS.	ACO	Counts	
On ramp	Q3/92	No observations											-		
	Q4/92	No observations											-		
	Q1/93	5084	482	38	21	39	82	5	463	13	8	6235	1.11	16	
	Q2/93	No observations											-		
	Q3/93	1342	131	16	10	7	21	0	12	6	15	1560	1.13	5	
	Q4/93	2669	266	29	13	12	40	2	10	3	5	3049	1.12	10	
	Q1/94	1615	174	20	7	8	24	0	7	3	3	1861	1.13	5	
	Q2/94	2778	330	34	24	10	39	0	29	6	4	3254	1.15	5	
	Q3/94	3099	320	40	13	16	45	0	10	3	15	3561	1.13	20	
	Q4/94	1808	188	26	5	9	40	1	23	4	1	2105	1.13	10	
	Q1/95	1826	115	5	0	9	22	2	12	4	0	1995	1.06	6	
	Q2/95	1180	105	12	11	3	17	1	19	8	1	1357	1.13	5	
	Q3/95	No observations											-		

82

**I-405 South - S Park Drive**

**a.m. southbound**

	Qtr.	1	2	3	4+	Van	Public Transit	Other Bus	2 Axle	3+ Axle	Motor- cycle	TOTAL OBS.	ACO	Counts	
On ramp	Q3/92	No observations											-		
	Q4/92	910	89	8	3	0	10	5	15	24	1	1065	1.11	6	
	Q1/93	680	48	4	1	1	0	4	20	14	0	771	1.08	4	
	Q2/93	609	52	10	2	0	0	0	15	31	0	719	1.12	4	
	Q3/93	No observations											-		
	Q4/93	1555	122	6	3	0	0	0	65	95	2	1848	1.09	5	
	Q1/94	990	85	12	4	0	0	4	38	23	2	1158	1.11	7	
	Q2/94	518	33	1	4	0	0	1	8	17	1	583	1.09	5	
	Q3/94	1450	119	5	8	0	0	2	34	65	8	1691	1.10	9	
	Q4/94	1360	119	6	3	0	0	3	42	63	3	1599	1.09	9	
	Q1/95	641	35	3	1	1	0	2	15	21	2	721	1.07	3	
	Q2/95	568	37	0	4	1	4	1	11	28	2	656	1.08	5	
	Q3/95	No observations											--		

57

**p.m. southbound**

	Qtr.	1	2	3	4+	Van	Public Transit	Other Bus	2 Axle	3+ Axle	Motor- cycle	TOTAL OBS.	ACO	Counts	
On ramp	Q3/92	No observations											-		
	Q4/92	No observations											-		
	Q1/93	1781	326	65	18	9	7	0	304	28	4	2542	1.23	12	
	Q2/93	No observations											-		
	Q3/93	No observations											-		
	Q4/93	1513	239	29	6	23	6	0	45	21	2	1884	1.18	9	
	Q1/94	924	189	30	17	10	2	1	19	13	3	1208	1.26	5	
	Q2/94	663	128	24	9	4	2	0	21	17	4	872	1.25	4	
	Q3/94	1692	386	65	35	19	5	2	59	27	13	2303	1.29	10	
	Q4/94	1854	204	22	19	12	7	0	44	42	9	2213	1.15	10	
	Q1/95	473	66	8	8	3	3	0	13	9	2	585	1.19	3	
	Q2/95	818	139	13	0	4	4	0	10	14	2	1004	1.17	5	
	Q3/95	No observations											-		

58

**I-405 South - S Park Drive**

**a.m. northbound**

	Qtr.	1	2	3	4+	Van	Public Transit	Other Bus	2 Axle	3+ Axle	Motor- cycle	TOTAL OBS.	ACO	Counts	
Off ramp	Q3/92	310	41	3	2	1	0	1	11	19	3	391	1.15	4	
	Q4/92	362	29	3	0	1	0	0	18	24	0	437	1.09	3	
	Q1/93	504	35	8	1	1	0	3	26	26	0	604	1.10	4	
	Q2/93	534	48	7	6	0	0	1	26	28	2	652	1.14	3	
	Q3/93	No observations											-		
	Q4/93	372	28	4	2	0	0	4	21	16	0	447	1.10	3	
	Q1/94	961	127	11	2	2	0	6	52	41	1	1203	1.14	7	
	Q2/94	1465	113	14	11	4	0	4	75	69	8	1763	1.11	10	
	Q3/94	No observations											-		
	Q4/94	702	66	9	1	2	0	2	32	47	0	861	1.11	7	
	Q1/95	371	29	5	1	0	0	1	20	21	1	449	1.10	3	
	Q2/95	617	41	2	2	2	1	4	26	40	14	749	1.08	6	
	Q3/95	No observations											-		

50

**p.m. northbound**

	Qtr.	1	2	3	4+	Van	Public Transit	Other Bus	2 Axle	3+ Axle	Motor- cycle	TOTAL OBS.	ACO	Counts	
Off ramp	Q3/92	No observations											-		
	Q4/92	513	13	3	0	0	0	1	11	2	1	544	1.04	3	
	Q1/93	2183	274	26	3	0	3	0	37	20	8	2554	1.13	13	
	Q2/93	No observations											-		
	Q3/93	975	176	20	13	1	0	0	22	9	7	1223	1.22	6	
	Q4/93	1402	2301	34	11	1	0	0	3	28	8	1717	1.20	6	
	Q1/94	708	127	22	3	1	0	0	9	10	1	881	1.21	4	
	Q2/94	1678	287	43	14	6	0	1	24	36	6	2095	1.21	6	
	Q3/94	1486	325	49	30	0	1	0	67	30	15	2003	1.27	14	
	Q4/94	1049	249	34	36	0	0	2	33	19	6	1428	1.32	8	
	Q1/95	850	102	6	4	0	0	1	23	23	2	1011	1.13	5	
	Q2/95	980	154	9	6	0	5	1	20	17	3	1195	1.17	5	
	Q3/95	No observations											-		

70

**I-405 South - S Park Drive**

**a.m. southbound**

	Qtr.	1	2	3	4+	Van	Public Transit	Other Bus	2 Axle	3+ Axle	Motor- cycle	TOTAL OBS.	ACO	Counts	
Off ramp	Q3/92	1305	142	17	9	8	12	0	18	8	40	1559	1.14	5	
	Q4/92	799	74	4	0	6	9	0	5	8	1	905	1.09	3	
	Q1/93	2183	164	9	2	6	19	5	12	5	2	2407	1.08	6	
	Q2/93	1029	58	8	3	3	9	1	16	5	1	1133	1.08	4	
	Q3/93	No observations											--		
	Q4/93	211	10	1	2	0	1	2	5	2	0	234	1.08	1	
	Q1/94	1647	107	11	0	1	10	10	39	3	2	1830	1.07	7	
	Q2/94	1488	81	11	1	9	15	4	19	11	1	1641	1.07	5	
	Q3/94	3149	211	21	6	16	31	2	42	23	13	3514	1.08	10	
	Q4/94	1766	114	3	16	2	23	4	24	13	0	1965	1.09	8	
	Q1/95	710	54	6	3	1	5	2	16	11	0	808	1.10	3	
	Q2/95	1467	71	3	1	7	14	2	19	4	10	1598	1.05	6	
	Q3/95	No observations											--		
															58

**p.m. southbound**

	Qtr.	1	2	3	4+	Van	Public Transit	Other Bus	2 Axle	3+ Axle	Motor- cycle	TOTAL OBS.	ACO	Counts	
Off ramp	Q3/92	No observations											--		
	Q4/92	478	72	9	3	8	11	1	12	5	0	599	1.18	3	
	Q1/93	2056	380	60	22	15	53	3	46	9	1	2645	1.23	13	
	Q2/93	No observations											--		
	Q3/93	No observations											--		
	Q4/93	1642	224	41	16	43	41	3	37	14	0	2061	1.19	10	
	Q1/94	790	182	41	6	29	22	2	15	1	2	1090	1.28	5	
	Q2/94	875	187	23	13	20	21	0	17	7	3	1166	1.25	5	
	Q3/94	1674	350	75	33	38	39	0	42	13	21	2285	1.28	10	
	Q4/94	1105	206	22	4	48	29	6	33	10	3	1466	1.20	8	
	Q1/95	672	53	2	2	21	18	5	18	8	0	799	1.09	5	
	*Q2/95	168	107	9	18	9	11	2	0	0	1	325	1.60	2	
	Q3/95	No observations											--		
															61

\* Only 2 count, variation in ACO may be due to special week-end trip.

**SITE #65. I-405 SOUTH - 112 Avenue SE/Lk Washington Blvd**

▲ Mainline ACO NB & SB-am & pm

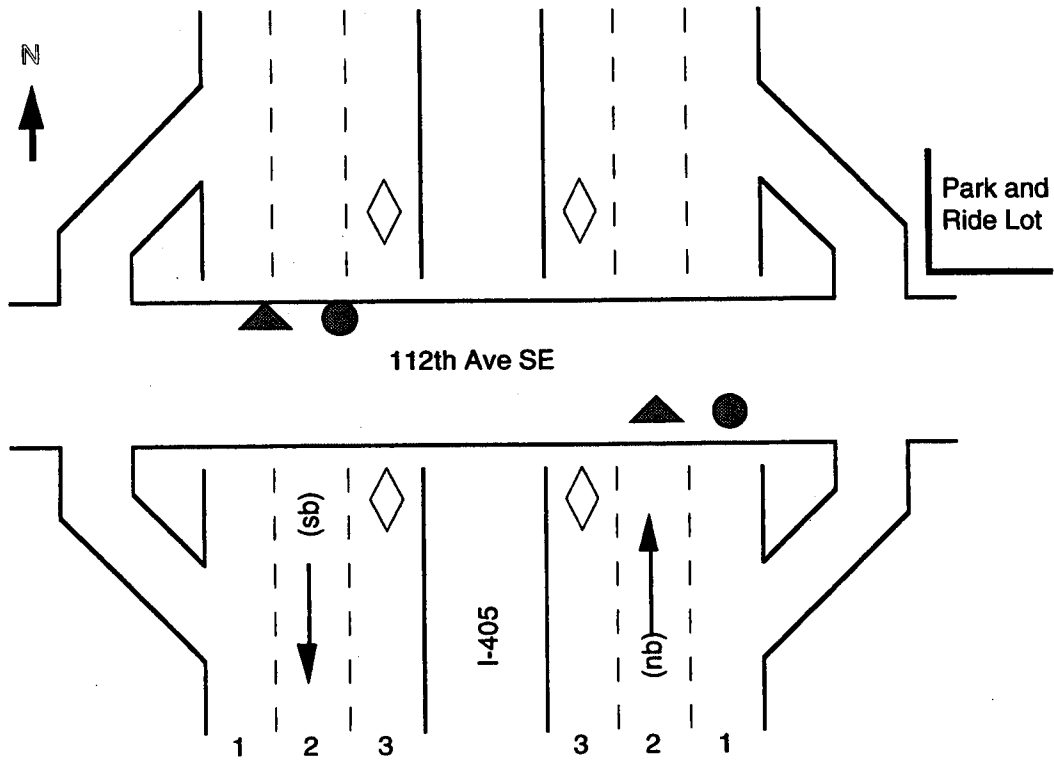

**Note: HOV lanes switched from outside to inside Q1/97.**

**I-405 SOUTH - 112 Avenue SE/Lk Washington Blvd**

**a.m. northbound**

	Qtr.	1	2	3	4+	Van	Public Transit	Other Bus	2 Axle	3+ Axle	Motor- cycle	TOTAL OBS.	ACO	Counts
HOV	Q3/92	15	317	55	23	5	1	0	2	0	13	431	2.22	2
lanes	Q4/92	No observations											--	
1	Q1/93	99	1168	99	9	24	8	9	18	0	14	1448	2.01	5
	Q2/93	45	716	103	21	16	5	1	17	0	17	941	2.12	4
	Q3/93	168	1681	226	57	21	15	11	56	1	65	2301	2.09	8
	Q4/93	48	538	141	63	8	4	4	16	1	4	827	2.29	4
	Q1/94	153	976	89	20	20	7	10	14	0	16	1305	1.98*	6
	Q2/94	46	899	109	25	20	5	7	18	0	26	1155	2.11	5
	Q3/94	57	1014	113	44	6	15	10	23	2	49	1333	2.12	7
	Q4/94	76	1228	92	24	23	6	11	25	1	18	1504	2.05	6
	Q1/95	67	1962	94	15	27	9	14	36	4	11	2239	2.03	10
	Q2/95	152	2366	155	30	51	16	11	52	3	47	2883	2.03	11
	Q3/95	34	990	54	16	16	10	6	28	1	37	1192	2.05	8
	No observations conducted Q4/95 - Q2/96												--	
	Q3/96	47	1725	117	31	53	20	4	47	1	102	2147	2.07	8
	No observations conducted Q4/96 - Q1/97												--	
	Q2/97	291	3609	179	27	92	6	12	40	1	88	4345	1.99*	13
	Q3/97	842	3553	379	102	95	6	15	77	12	139	5220	1.95*	11
	No observations conducted Q4/97 - Q1/98												--	
	Q2/98	230	3981	384	91	88	5	22	139	6	135	5081	2.08	10

118

\* ACO lower due to several violators detected in one count.

**I-405 South - 112th Avenue SE/ Lake Washington Blvd.**

<b>a.m. northbound</b>													<b>TOTAL ACO</b>		<b>Counts</b>
		<b>Qtr.</b>	<b>1</b>	<b>2</b>	<b>3</b>	<b>4+</b>	<b>Van</b>	<b>Public Transit</b>	<b>Other Bus</b>	<b>2 Axle</b>	<b>3+ Axle</b>	<b>Motor- cycle</b>	<b>OBS.</b>		
<b>GP lanes</b>		<b>Q3/92</b>	938	56	6	4	0	0	1	39	116	2	<b>1162</b>	<b>1.08</b>	<b>2</b>
		<b>Q4/92</b>	No observations											--	
<b>2</b>		<b>Q1/93</b>	7791	155	10	2	3	1	1	255	247	0	<b>8465</b>	<b>1.02</b>	<b>10</b>
		<b>Q2/93</b>	4662	137	26	9	1	1	1	184	261	4	<b>5286</b>	<b>1.05</b>	<b>6</b>
		<b>Q3/93</b>	8857	249	26	31	3	2	4	364	505	12	<b>10053</b>	<b>1.04</b>	<b>15</b>
		<b>Q4/93</b>	5786	294	35	14	7	0	3	189	298	0	<b>6626</b>	<b>1.07</b>	<b>9</b>
		<b>Q1/94</b>	5888	151	14	10	0	0	3	232	345	4	<b>6647</b>	<b>1.03</b>	<b>11</b>
		<b>Q2/94</b>	5346	132	13	4	3	0	3	237	355	2	<b>6095</b>	<b>1.03</b>	<b>8</b>
		<b>Q3/94</b>	4802	78	10	6	3	1	5	155	261	2	<b>5323</b>	<b>1.02</b>	<b>8</b>
		<b>Q4/94</b>	2197	69	3	2	0	1	2	147	250	0	<b>2671</b>	<b>1.04</b>	<b>4</b>
		<b>Q1/95</b>	4107	262	16	5	2	2	3	139	262	1	<b>4799</b>	<b>1.07</b>	<b>7</b>
		<b>Q2/95</b>	4447	98	4	1	2	0	3	161	295	12	<b>5023</b>	<b>1.02</b>	<b>8</b>
		<b>Q3/95</b>	2362	39	4	1	0	0	1	80	192	1	<b>2680</b>	<b>1.02</b>	<b>6</b>
		No observations conducted Q4/95 - Q2/96											-		
		<b>Q3/96</b>	2849	93	6	5	5	0	1	99	187	1	<b>3246</b>	<b>1.04</b>	<b>6</b>
		No observations conducted Q4/96 - Q1/97											-		
		<b>Q2/97</b>	4563	64	2	2	0	3	0	101	244	2	<b>4981</b>	<b>1.02</b>	<b>10</b>
		<b>Q3/97</b>	5280	114	17	7	10	3	6	189	438	1	<b>6065</b>	<b>1.03</b>	<b>9</b>
		No observations conducted Q4/97 - Q1/98											-		
		<b>Q2/98</b>	5941	95	4	27	1	7	2	210	339	0	<b>6626</b>	<b>1.03</b>	<b>8</b>

**I-405 South - 112th Avenue SE/ Lake Washington Blvd.**

**p.m. northbound**

	Qtr.	1	2	3	4+	Van	Public Transit	Other Bus	2 Axle	3+ Axle	Motor- cycle	TOTAL ACO OBS.	Counts	
HOV	Q3/92	No observations											--	
lanes	Q4/92	No observations											--	
1	Q1/93	67	829	95	27	8	6	0	318	3	6	1359	2.09	8
	Q2/93	101	984	150	16	13	6	1	12	1	6	1290	2.07	5
	Q3/93	48	1047	217	100	17	10	10	28	1	23	1501	2.28	7
	Q4/93	17	709	83	37	3	5	9	17	1	2	884	2.17	3
	Q1/94	34	1029	159	68	11	11	9	22	1	17	1361	2.21	5
	Q2/94	42	1105	173	68	11	9	2	8	1	28	1447	2.20	5
	Q4/94	856	1787	185	83	30	16	8	68	30	17	3080	1.83	9
	Q1/95	31	2344	235	114	30	22	12	26	1	23	2838	2.17	10
	Q2/95	238	3866	345	61	71	24	12	23	1	87	4728	2.05	12
	Q3/95	105	2883	278	65	63	13	10	16	0	51	3484	2.09	8
	No observations conducted Q4/95 - Q2/96												--	
	Q3/96	71	2560	239	66	37	19	3	43	5	54	3097	2.11	8
	No observations conducted Q4/96 - Q1/97												--	
	Q2/97	193	3172	548	129	65	12	2	32	0	65	4218	2.16	12
	Q3/97	189	2260	536	183	80	7	13	47	1	61	3377	2.24	9
	No observations conducted Q4/97 - Q1/98												--	
	Q2/98	191	5726	755	199	65	16	45	121	11	75	7204	2.15	19

120



**I-405 South - 112th Avenue SE/ Lake Washington Blvd.**

<b>p.m. northbound</b>													<b>TOTAL ACO Counts</b>		
<b>Qtr.</b>		<b>1</b>	<b>2</b>	<b>3</b>	<b>4+</b>	<b>Van</b>	<b>Public Transit</b>	<b>Other Bus</b>	<b>2 Axle</b>	<b>3+ Axle</b>	<b>Motor-cycle</b>	<b>OBS.</b>			
<b>GP lanes</b>	<b>2</b>	<b>Q3/92 No observations</b>											<b>--</b>		
		<b>Q4/92 No observations</b>											<b>--</b>		
		<b>Q1/93</b>	8091	610	21	11	4	1	1	1194	132	2	<b>10067</b>	<b>1.08</b>	<b>19</b>
		<b>Q2/93</b>	6664	526	48	3	3	0	1	135	143	2	<b>7525</b>	<b>1.09</b>	<b>8</b>
		<b>Q3/93</b>	6377	528	67	29	0	3	2	141	194	8	<b>7349</b>	<b>1.11</b>	<b>11</b>
		<b>Q4/93</b>	3412	277	54	17	0	0	2	91	80	1	<b>3934</b>	<b>1.12</b>	<b>5</b>
		<b>Q1/94</b>	6637	360	29	19	1	0	2	110	129	3	<b>7290</b>	<b>1.07</b>	<b>8</b>
		<b>Q2/94</b>	4762	314	36	20	2	2	1	83	95	6	<b>5321</b>	<b>1.09</b>	<b>7</b>
		<b>Q3/94</b>	8188	611	110	60	2	0	1	239	234	18	<b>9463</b>	<b>1.11</b>	<b>12</b>
		<b>Q4/94</b>	3676	177	15	10	0	0	2	89	100	0	<b>4069</b>	<b>1.06</b>	<b>5</b>
		<b>Q1/95</b>	4682	228	23	15	2	0	0	124	133	4	<b>5211</b>	<b>1.07</b>	<b>6</b>
		<b>Q2/95</b>	8147	466	42	12	10	0	1	183	289	6	<b>9156</b>	<b>1.07</b>	<b>11</b>
		<b>Q3/95</b>	6350	260	29	8	5	0	0	160	209	11	<b>7032</b>	<b>1.05</b>	<b>9</b>
		<b>No observations conducted Q4/95 - Q2/96</b>											<b>-</b>		
		<b>Q3/96</b>	4619	190	24	5	1	0	1	122	158	5	<b>5125</b>	<b>1.05</b>	<b>7</b>
		<b>No observations conducted Q4/96 - Q1/97</b>											<b>-</b>		
		<b>Q2/97</b>	8785	587	87	39	30	7	2	204	203	7	<b>9951</b>	<b>1.09</b>	<b>12</b>
		<b>Q3/97</b>	4608	319	64	13	8	5	5	89	170	5	<b>5286</b>	<b>1.10</b>	<b>6</b>
		<b>No observations conducted Q4/97 - Q1/98</b>											<b>-</b>		
		<b>Q2/98</b>	12894	920	96	27	15	24	14	389	354	6	<b>14739</b>	<b>1.09</b>	<b>16</b>

142

**I-405 South - 112th Avenue SE/ Lake Washington Blvd.**

**a.m. southbound**

	Qtr.	1	2	3	4+	Van	Public Transit	Other Bus	2 Axle	3+ Axle	Motor- cycle	TOTAL OBS.	ACO	Counts	
HOV lanes	Q3/92	No observations										--			
	Q4/92	No observations										--			
1	Q1/93	46	691	53	11	55	8	6	4	0	4	<b>848</b>	<b>2.04</b>	5	
	Q2/93	10	230	31	14	6	2	4	12	0	4	<b>313</b>	<b>2.18</b>	2	
	Q3/93	30	600	114	36	6	4	8	18	1	20	<b>837</b>	<b>2.21</b>	7	
	Q4/93	12	99	85	44	1	1	4	8	0	1	<b>255</b>	<b>2.71</b>	2	
	Q1/94	119	853	65	26	12	5	4	17	0	4	<b>1105</b>	<b>2.00</b>	7	
	Q2/94	32	602	79	18	19	4	4	7	1	13	<b>779</b>	<b>2.12</b>	5	
	Q3/94	36	518	66	31	7	15	7	12	0	18	<b>710</b>	<b>2.15</b>	4	
	Q4/94	42	680	54	12	12	10	8	16	7	18	<b>853</b>	<b>2.05</b>	6	
	Q1/95	40	1188	64	18	24	14	19	22	0	8	<b>1397</b>	<b>2.05</b>	11	
	Q2/95	40	1184	82	22	33	17	13	17	0	38	<b>1446</b>	<b>2.07</b>	11	
	Q3/95	5	506	30	13	10	18	8	8	1	25	<b>624</b>	<b>2.10</b>	8	
	No observations conducted Q4/95 - Q2/96												--		
	Q3/96	150	1467	104	47	32	19	1	36	17	54	<b>1927</b>	<b>2.03</b>	9	
	No observations conducted Q4/96 - Q1/97												--		
	Q2/97	54	1662	105	18	54	5	8	31	0	28	<b>1965</b>	<b>2.05</b>	13	
	Q3/97	35	1969	197	49	56	2	6	20	0	87	<b>2421</b>	<b>2.12</b>	10	
	No observations conducted Q4/97 - Q1/98												--		
Q2/98	35	1524	164	50	54	5	23	78	1	47	<b>1981</b>	<b>2.13</b>	12		
														112	

**I-405 South - 112th Avenue SE/ Lake Washington Blvd.**

**a.m. southbound**

		Qtr.	1	2	3	4+	Van	Public Transit	Other Bus	2 Axle	3+ Axle	Motor- cycle	TOTAL ACO OBS.	Counts	
GP lanes		No observations												--	
		No observations												--	
2	Q1/93	5202	296	10	8	1	2	2	2	132	180	4	<b>5837</b>	<b>1.06</b>	16
	Q2/93	3594	204	14	5	2	0	0	0	97	201	0	<b>4117</b>	<b>1.06</b>	6
	Q3/93	6980	400	36	11	0	1	1	1	185	279	5	<b>7898</b>	<b>1.07</b>	11
	Q4/93	3097	116	27	10	0	0	2	2	99	94	0	<b>3445</b>	<b>1.08</b>	6
	Q1/94	6509	124	11	3	1	0	3	3	239	219	1	<b>7110</b>	<b>1.02</b>	10
	Q2/94	5887	216	20	3	1	0	0	5	165	304	2	<b>6598</b>	<b>1.04</b>	9
	Q3/94	5670	346	64	30	2	3	5	5	210	257	5	<b>6592</b>	<b>1.09</b>	10
	Q4/94	2393	108	5	0	1	1	0	0	96	131	1	<b>2736</b>	<b>1.05</b>	5
	Q1/95	3043	81	6	0	3	1	1	1	109	191	0	<b>3435</b>	<b>1.03</b>	7
	Q2/95	4746	122	7	8	3	0	0	0	144	215	3	<b>5248</b>	<b>1.03</b>	9
	Q3/95	1538	85	1	5	2	0	2	2	51	107	0	<b>1791</b>	<b>1.06</b>	6
	No observations conducted Q4/95 - Q2/96												--		
	Q3/96	3198	214	15	15	3	1	1	1	98	150	6	<b>3701</b>	<b>1.08</b>	7
	No observations conducted Q4/96 - Q1/97												--		
	Q2/97	4183	132	15	2	6	2	2	2	124	216	1	<b>4683</b>	<b>1.04</b>	8
	Q3/97	6372	218	33	7	6	0	3	3	192	355	2	<b>7188</b>	<b>1.05</b>	11
	No observations conducted Q4/97 - Q1/98												--		
	Q2/98	5638	177	17	3	5	4	3	3	197	241	5	<b>6290</b>	<b>1.04</b>	8

**I-405 South - 112th Avenue SE/ Lake Washington Blvd.**

**p.m. southbound**

	Qtr.	1	2	3	4+	Van	Public Transit	Other Bus	2 Axle	3+ Axle	Motor- cycle	TOTAL OBS.	ACO	Counts
HOV lanes	Q3/92	No observations											--	
	Q4/92	No observations											--	
1	Q1/93	136	736	27	1	0	1	2	3	1	15	922	1.88	6
	Q2/93	28	708	120	33	23	2	6	181	1	10	1112	2.19	4
	Q3/93	47	1171	200	75	23	5	10	23	1	30	1585	2.21	5
	Q4/93	157	718	86	73	21	1	4	12	0	12	1084	2.09	3
	Q1/94	58	1293	253	67	62	1	4	8	0	22	1768	2.20	5
	Q2/94	35	1279	215	74	56	1	9	18	0	32	1719	2.21	5
	Q3/94	160	2553	299	136	106	19	7	17	1	74	3372	2.14	8
	Q4/94	74	1941	135	52	64	5	7	26	2	14	2320	2.08	7
	Q1/95	115	3312	233	63	140	5	13	36	0	24	3941	2.07	10
	Q2/95	170	3994	436	168	133	8	15	44	4	58	5030	2.13	10
	Q3/95	192	4084	375	122	128	9	9	39	2	102	5062	2.09	9
	No observations conducted Q4/95 - Q2/96											--		
	Q3/96	114	2407	272	106	85	2	6	27	0	94	3113	2.13	6
	No observations conducted Q4/96 - Q1/97											--		
	Q2/97	142	3098	478	113	102	1	2	23	0	65	4024	2.15	7
	Q3/97	457	5595	680	275	116	5	6	35	2	108	7279	2.12	13
	No observations conducted Q4/97 - Q1/98											--		
	Q2/98	141	5082	920	219	195	3	36	209	3	94	6902	2.20	14
	<b>112</b>													

**I-405 South - 112th Avenue SE/ Lake Washington Blvd.**

<b>p.m. southbound</b>		Qtr.	1	2	3	4+	Van	Public Transit	Other Bus	2 Axle	3+ Axle	Motor- cycle	TOTAL ACO OBS.	Counts	
GP lanes	2	Q3/92	No observations											--	
		Q4/92	No observations											--	
		Q1/93	13690	1034	27	1	3	0	1	269	250	4	15219	1.07	13
		Q2/93	4690	419	45	3	5	1	2	1231	171	6	6573	1.10	8
		Q3/93	6136	603	75	36	4	1	2	221	204	9	7291	1.13	8
		Q4/93	7919	618	15	4	1	2	1	143	188	6	8897	1.08	11
		Q1/94	6345	534	63	8	10	0	1	181	183	0	7325	1.10	8
		Q2/94	4899	384	53	13	4	0	0	131	129	5	5618	1.10	7
		Q3/94	8906	548	68	28	5	6	2	267	299	17	10146	1.08	14
		Q4/94	5062	178	15	4	4	0	0	143	160	1	5567	1.04	7
		Q1/95	7412	260	21	1	2	0	0	161	214	1	8072	1.04	9
		Q2/95	6169	426	32	17	8	0	2	168	322	3	7147	1.08	10
		Q3/95	6603	260	27	9	6	0	1	179	223	5	7313	1.05	9
		No observations conducted Q4/95 - Q2/96											--		
		Q3/96	3167	145	12	9	7	0	0	106	134	4	3584	1.06	5
		No observations conducted Q4/96 - Q1/97											--		
		Q2/97	4510	278	37	8	7	0	0	130	114	1	5085	1.08	6
		Q3/97	8186	587	50	20	7	5	2	136	242	5	9240	1.08	11
		No observations conducted Q4/97 - Q1/98											--		
		Q2/98	13665	506	49	17	3	43	14	402	442	5	15146	1.05	19
														145	

<b>a.m. northbound</b>		Qtr.	1	2	3	4+	Van	Public Transit	Other Bus	2 Axle	3+ Axle	Motor- cycle	TOTAL ACO OBS.	Counts	
On ramp		Q3/92	No observations											--	
		Q4/92	742	72	8	2	0	11	0	4	1	2	842	1.11	6
		Q1/93	913	160	9	3	10	37	0	0	1	5	1138	1.17	8
		Observations suspended Q2/93											--		
														14	

**Vehicle Occupancy (ACO) Sites  
I-405 (Corridors #7 & 8)**

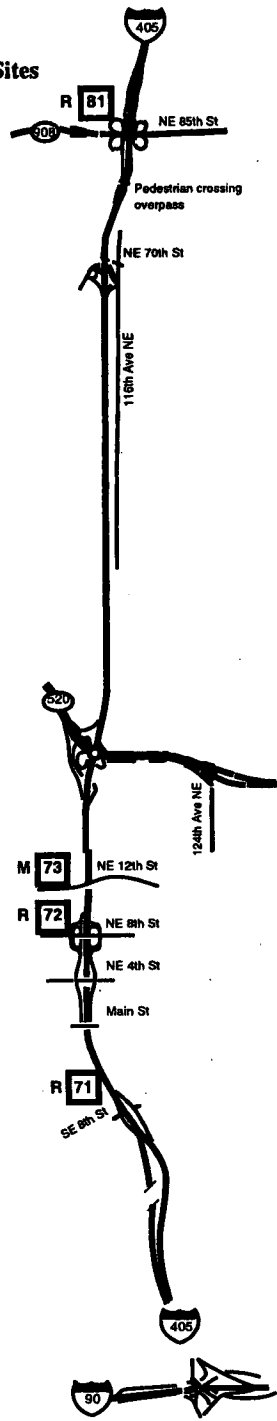

- ACO Site
- M Mainline
- R Ramp

**SITE #71. I-405 CENTRAL - SE 8th Street**

- ACO on/ramp NB & SB-am & pm
- ACO off/ramp NB & SB-am & pm

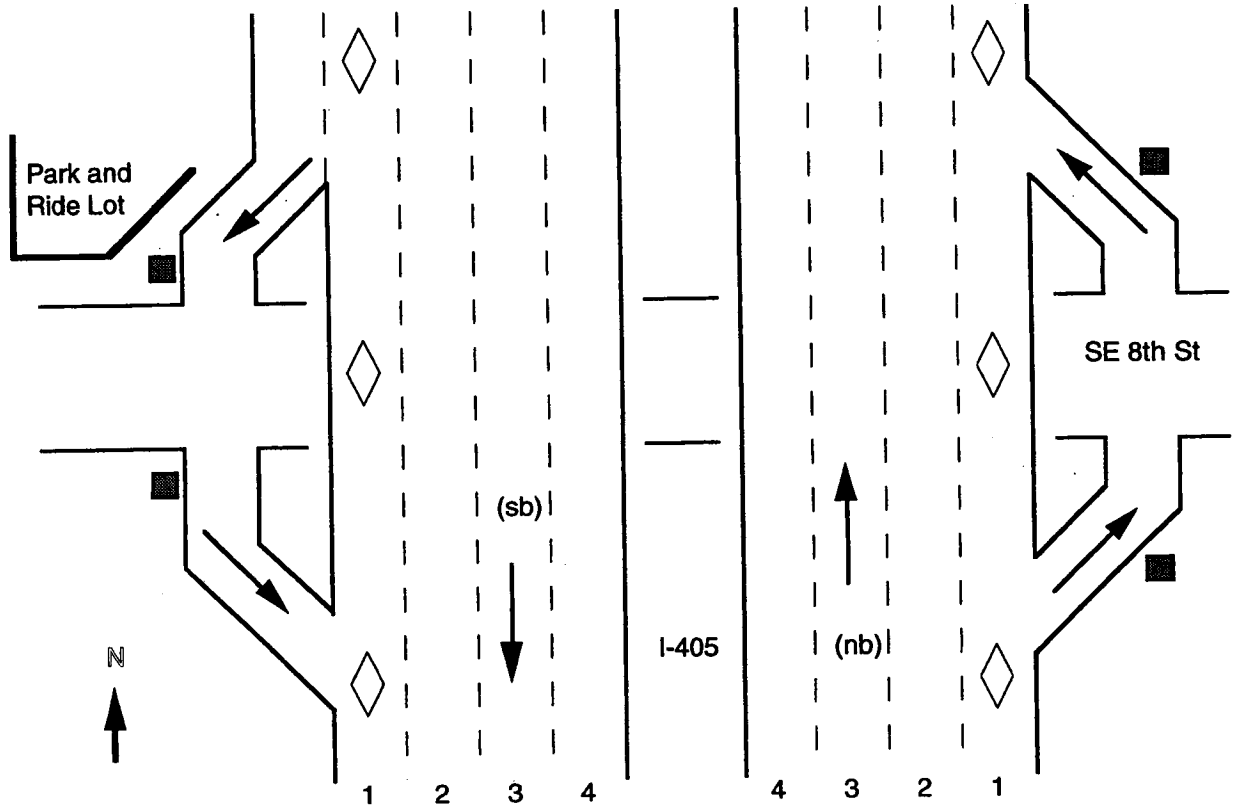

**a.m. northbound**

	Qtr.	1	2	3	4+	Van	Public Transit	Other Bus	2 Axle	3+ Axle	Motor- cycle	TOTAL OBS.	ACO	Counts
On ramp	Q3/92	1589	136	12	6	5	16	3	39	21	3	1830	1.10	8
	Q4/92	1035	74	16	6	3	9	4	38	12	0	1197	1.11	6
	Q1/93	No observations											--	
	Q2/93	No observations											--	
	Q3/93	756	85	11	4	4	7	2	47	10	2	928	1.14	5
	Q4/93	943	96	22	4	0	10	3	17	6	1	1102	1.14	5
	Q1/94	1356	145	22	5	0	11	5	60	27	1	1632	1.13	7
	Q2/94	1608	149	40	5	4	20	3	57	24	9	1919	1.14	9
	Q3/94	786	103	8	9	8	10	0	35	32	1	992	1.16	6
	Q4/94	618	50	8	5	1	8	3	42	13	0	748	1.12	4
	Q1/95	1118	117	8	1	2	10	6	37	9	0	1308	1.11	7
	Q2/95	580	61	2	0	3	8	3	28	14	0	699	1.10	5
	Q3/95	No observation											--	

**I-405 Central - SE 8th Street**

**p.m. northbound**

	Qtr.	1	2	3	4+	Van	Public Transit	Other Bus	2 Axle	3+ Axle	Motor- cycle	TOTAL OBS.	ACO	Counts
On ramp	Q3/92	1227	154	29	21	3	0	1	30	8	6	1479	1.20	7
	Q4/92	991	112	19	4	1	0	1	19	5	3	1155	1.14	4
	Q1/93	1629	198	23	11	1	5	2	28	5	0	1902	1.15	7
	Q2/93	1170	180	21	6	2	1	5	26	7	5	1423	1.18	5
	Q3/93	No observations											--	
	Q4/93	3421	541	83	33	3	11	3	48	8	5	4156	1.20	18
	Q1/94	2062	307	60	23	1	9	9	27	6	2	2506	1.20	8
	Q2/94	2341	370	41	21	5	6	0	34	8	13	2839	1.19	11
	Q3/94	2507	340	49	22	12	7	2	52	7	11	3009	1.17	12
	Q4/94	1148	171	15	8	2	1	2	20	4	0	1371	1.17	5
	Q1/95	1047	98	9	1	2	1	2	20	5	1	1186	1.10	5
	Q2/95	1346	184	5	10	6	2	0	15	6	5	1579	1.15	6
	Q3/95	No observations											--	
	<b>88</b>													

**a.m. southbound**

	Qtr.	1	2	3	4+	Van	Public Transit	Other Bus	2 Axle	3+ Axle	Motor- cycle	TOTAL OBS.	ACO	Counts
On ramp	Q3/92	288	54	9	2	3	1	0	7	5	1	370	1.22	4
	Q4/92	No observations											--	
	Q1/93	No observations											--	
	Q2/93	No observations											--	
	Q3/93	342	65	10	9	0	1	5	14	8	0	454	1.27	9
	Q4/93	478	43	6	7	0	0	5	19	11	2	571	1.14	4
	Q1/94	271	29	2	2	2	1	4	6	6	0	323	1.13	4
	Q2/94	405	70	6	0	0	0	8	8	8	0	505	1.17	5
	Q3/94	222	24	1	2	0	1	3	4	9	0	266	1.13	6
	Q4/94	294	38	10	5	0	0	10	15	8	0	380	1.21	4
	Q1/95	176	26	2	1	0	0	4	8	4	0	221	1.16	3
	Q2/95	507	70	10	3	9	1	6	16	2	0	624	1.17	6
	Q3/95	No observations											--	
	<b>45</b>													



**I-405 Central - SE 8th Street**

**p.m. southbound**

	Qtr.	1	2	3	4+	Van	Public Transit	Other Bus	2 Axle	3+ Axle	Motor- cycle	TOTAL OBS.	ACO	Counts
On ramp	Q3/92	1018	130	27	13	1	5	0	8	6	6	1214	1.19	3
	Q4/92	1070	92	6	0	3	8	2	11	8	3	1203	1.09	4
	Q1/93	2987	269	28	11	6	30	10	16	5	0	3362	1.11	12
	Q2/93	1389	185	54	18	12	14	0	7	6	4	1689	1.21	5
	Q3/93	No observations											--	
	Q4/93	3600	476	85	13	28	39	4	13	4	4	4266	1.16	10
	Q1/94	1680	278	61	10	20	13	3	16	5	4	2090	1.21	6
	Q2/94	1382	177	23	26	16	9	3	24	5	4	1669	1.19	4
	Q3/94	3133	477	97	33	30	22	3	20	8	21	3844	1.21	11
	Q4/94	3113	420	35	14	30	19	3	33	4	6	3677	1.15	11
	Q1/95	1096	98	7	2	11	8	5	11	2	1	1241	1.10	5
	Q2/95	1437	277	43	11	12	11	4	10	6	2	1813	1.23	6
	Q3/95	No observations											--	

77

**a.m. northbound**

	Qtr.	1	2	3	4+	Van	Public Transit	Other Bus	2 Axle	3+ Axle	Motor- cycle	TOTAL OBS.	ACO	Counts
Off ramp	Q3/92	No observations											--	
	Q4/92	990	103	8	2	3	5	1	7	12	2	1133	1.11	6
	Q1/93	2213	210	13	7	4	13	4	386	10	2	2862	1.11	10
	Q2/93	No observations											--	
	Q3/93	983	96	16	2	3	7	0	18	8	2	1135	1.12	4
	Q4/93	514	42	8	2	0	3	1	8	3	0	581	1.11	3
	Q1/94	1511	131	11	2	1	9	0	24	9	2	1700	1.10	7
	Q2/94	1132	126	14	3	5	9	0	16	4	4	1313	1.13	5
	Q3/94	1214	135	27	5	6	9	2	23	9	5	1435	1.15	6
	Q4/94	909	57	5	4	1	8	7	18	13	2	1024	1.08	4
	Q1/95	1273	84	10	1	1	10	12	20	6	5	1422	1.08	7
	Q2/95	1178	141	13	1	5	7	0	10	4	2	1361	1.13	5
	Q3/95	No observations											--	

57

**I-405 Central - SE 8th Street**

**p.m. northbound**

	Qtr.	1	2	3	4+	Van	Public Transit	Other Bus	2 Axle	3+ Axle	Motor- cycle	TOTAL OBS.	ACO	Counts
Off ramp	Q3/92	No observations										--		
	Q4/92	540	84	21	10	0	0	4	24	2	1	686	1.24	4
	Q1/93	1230	219	42	14	6	0	10	39	1	2	1563	1.23	9
	Q2/93	No observations										--		
	Q3/93	No observations										--		
	Q4/93	1461	322	49	15	9	1	5	12	9	2	1885	1.25	9
	Q1/94	619	130	17	9	1	2	7	13	2	0	800	1.25	5
	Q2/94	1088	256	51	29	5	5	6	26	9	3	1478	1.32	7
	Q3/94	1483	334	54	29	8	7	2	27	13	10	1967	1.28	12
	Q4/94	1377	153	16	7	3	7	6	18	4	3	1594	1.13	13
	Q1/95	616	185	8	3	1	8	6	10	2	1	840	1.26	5
	Q2/95	657	207	43	15	15	4	0	13	4	2	960	1.37	6
	Q3/95	No observations										--		

70

**a.m. southbound**

	Qtr.	1	2	3	4+	Van	Public Transit	Other Bus	2 Axle	3+ Axle	Motor- cycle	TOTAL OBS.	ACO	Counts
Off ramp	Q3/92	2547	168	22	1	2	2	4	44	13	11	2814	1.08	8
	Q4/92	2695	328	12	3	1	3	3	39	12	0	3096	1.12	10
	Q1/93	4028	304	18	2	4	4	10	38	13	3	4424	1.08	12
	Q2/93	No observations										--		
	Q3/93	1250	131	19	8	9	5	9	25	8	3	1449	1.14	4
	Q4/93	2184	201	18	2	1	5	2	40	4	2	2459	1.10	7
	Q1/94	2264	168	14	4	0	9	6	38	16	6	2525	1.09	7
	Q2/94	2731	188	10	1	1	12	2	36	12	8	3001	1.07	10
	Q3/94	1607	163	16	5	2	6	1	21	17	5	1843	1.12	5
	Q4/94	1259	95	9	0	0	4	3	13	8	2	1393	1.08	4
	Q1/95	971	90	6	1	0	3	3	8	3	1	1086	1.10	3
	Q2/95	532	41	2	3	1	1	1	15	4	1	601	1.09	5
	Q3/95	No observations										--		

75

**I-405 Central - SE 8th Street**

**p.m. southbound**

	Qtr.	1	2	3	4+	Van	Public Transit	Other Bus	2 Axle	3+ Axle	Motor- cycle	TOTAL OBS.	ACO	Counts
Off ramp	Q3/92	1737	344	55	37	4	15	1	23	13	6	2235	1.26	5
	Q4/92	5398	757	60	29	18	40	4	71	38	14	6429	1.16	15
	Q1/93	3449	671	96	23	15	34	2	67	14	3	4374	1.22	9
	Q2/93	No observations											--	
	Q3/93	No observations											--	
	Q4/93	6242	1335	198	67	59	105	3	103	43	6	8161	1.25	19
	Q1/94	1446	345	47	18	12	26	0	27	7	1	1929	1.27	5
	Q2/94	3804	786	73	42	39	50	3	78	29	19	4923	1.23	11
	Q3/94	2023	385	87	40	23	26	2	70	15	5	2676	1.27	11
	Q4/94	2230	404	66	25	24	29	1	62	14	0	2855	1.23	10
	Q1/95	1583	239	26	2	17	19	0	21	8	0	1915	1.16	6
	Q2/95	1081	263	44	14	13	24	2	26	15	4	1486	1.28	6
	Q3/95	No observations											--	

**SITE #72. I-405 CENTRAL - NE 8th Street**

- ACO on/ramp NB & SB-am & pm
- ACO off/ramp NB & SB-am & pm

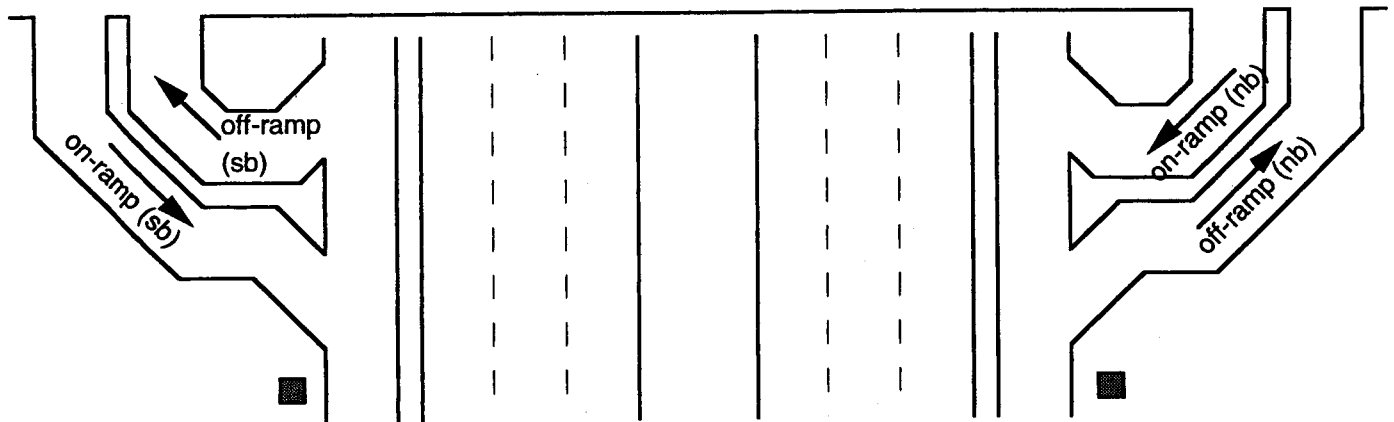
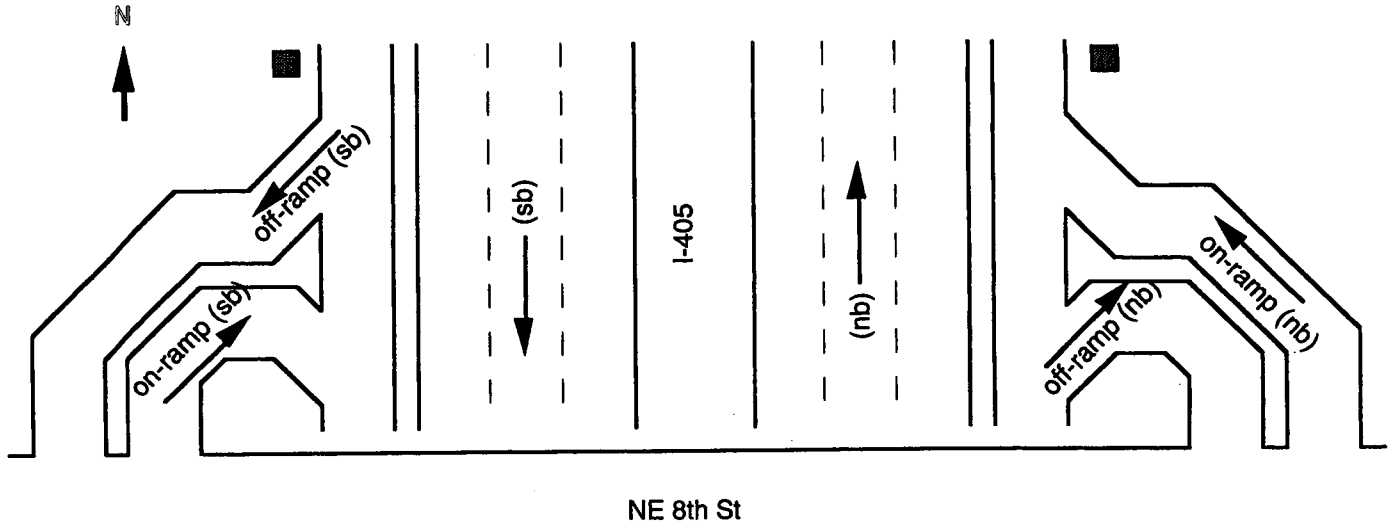

**Note:** Observations at this site were discontinued at the end of Q1/93.

**a.m. southbound**

	Qtr.	1	2	3	4+	Van	Public Transit	Other Bus	2 Axle	3+ Axle	Motor- cycle	TOTAL OBS.	ACO Counts
Off ramp	Q3/92	3527	270	17	3	2	2	1	56	26	8	3912	1.08
	Q4/92	No observations											--
	Q1/93	5626	374	18	0	1	2	2	78	21	9	6131	1.07

**I-405 CENTRAL - NE 8th Street**

p.m.	northbound											TOTAL OBS.	ACO	Counts	
	Qtr.	1	2	3	4+	Van	Public Transit	Other Bus	2 Axle	3+ Axle	Motor- cycle				
On	Q3/92	225	14	1	2	0	0	0	3	1	1	247	1.09	1	
ramp	Q4/92	No observations											--		
	Q1/93	No observations											--		1

**SITE #73a. I-405 CENTRAL - NE 12th Street**

▲ ACO mainline NB & SB-am & pm

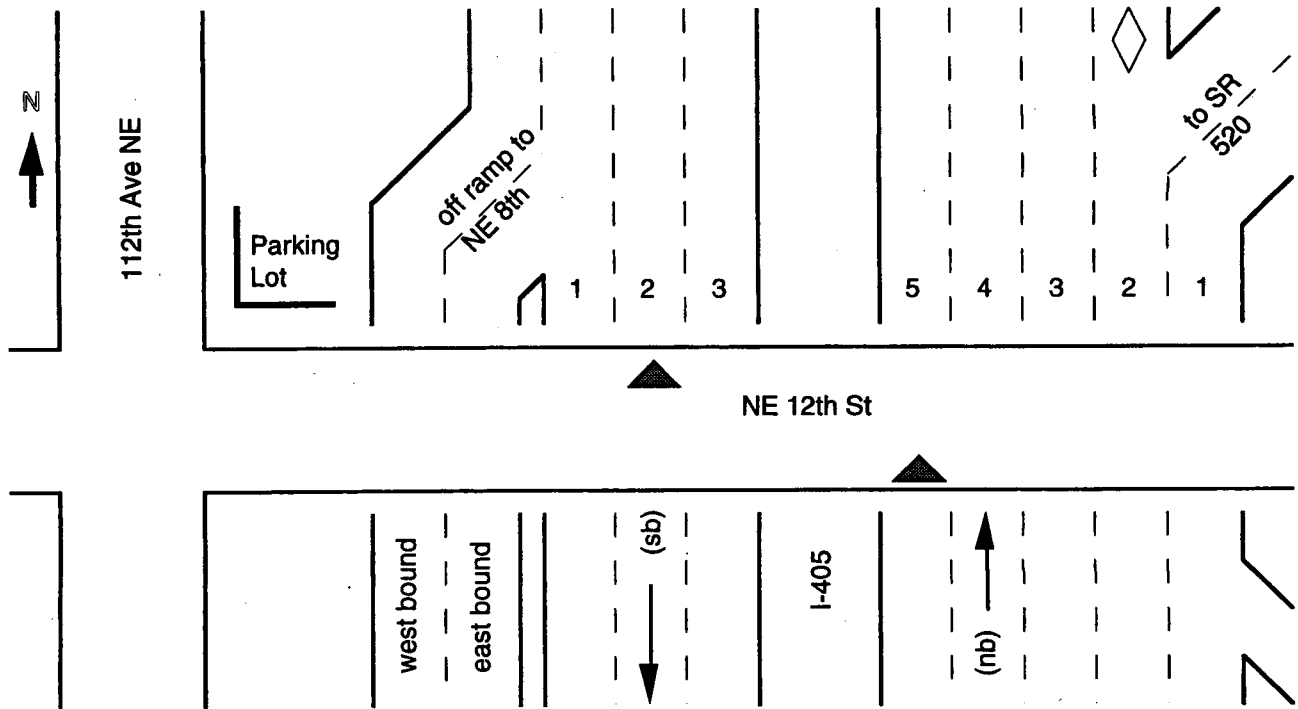

**Note:** The observation site was moved to I-405 Central - NE 4th Street in July 1994, due to weaving across outside HOV lanes. Lane 1 was opened as HOV SB & NB on July 9, 1994.

**a.m. northbound**

	Qtr.	1	2	3	4+	Van	Public Transit	Other Bus	2 Axle	3+ Axle	Motor- cycle	TOTAL OBS.	ACO Counts	
GP lanes	Q3/92	6606	727	48	8	2	16	3	164	274	21	7869	1.11	16
	Q4/92	No observations											--	
4 5*	Q1/93	No observations											--	
	Q2/93	945	115	12	3	2	3	0	4	65	4	1190	1.14	3
	Q3/93	8172	936	126	68	7	33	8	308	451	24	10133	1.15	20
	Q4/93	5393	619	87	23	8	21	5	212	238	31	6637	1.14	17
	Q1/94	5301	549	72	16	19	32	4	181	276	12	6462	1.13	20
	Q2/94	2900	278	23	15	5	10	5	116	152	13	3526	1.12	9

85

**I-405 CENTRAL - NE 12th Street**

**p.m. northbound**

	Qtr.	1	2	3	4+	Van	Public Transit	Other Bus	2 Axle	3+ Axle	Motor- cycle	TOTAL OBS.	ACO	Counts
GP lanes	Q3/92	4235	945	90	40	26	6	3	48	53	33	5479	1.24	10
	Q4/92	825	153	15	1	1	2	0	17	11	1	1026	1.19	2
4	Q1/93	No observations											--	
5*	Q2/93	7363	1465	204	31	7	19	5	177	106	17	9394	1.22	12
	Q3/93	15106	2961	320	134	14	38	8	403	289	91	19364	1.22	24
	Q4/93	6907	1382	143	60	23	14	5	186	89	5	8814	1.22	16
	Q1/94	6085	1131	134	53	1	15	3	148	100	12	7682	1.21	13
	Q2/94	7559	1220	173	83	10	15	4	195	127	51	9437	1.20	17
														94

\* Collector/distributor added to outside lane Q1/94.

**a.m southbound**

	Qtr.	1	2	3	4+	Van	Public Transit	Other Bus	2 Axle	3+ Axle	Motor- cycle	TOTAL OBS.	ACO	Counts
GP lanes	Q3/92	6837	906	85	12	5	18	4	131	220	21	8238	1.14	10
	Q4/92	3615	256	9	1	0	8	0	99	65	3	4056	1.07	5
3	Q1/93	No observations											--	
	Q2/93	3054	279	16	3	5	21	0	85	108	7	3578	1.10	6
	Q3/93	7668	839	67	36	6	21	8	239	237	27	9148	1.13	13
	Q4/93	5113	732	77	146	9	10	3	164	158	3	6415	1.22	11
	Q1/94	11719	1224	83	15	15	30	3	431	287	9	13816	1.11	20
	Q2/94	4358	531	25	11	1	13	4	160	143	13	5259	1.13	8
														73

**p.m southbound**

	Qtr.	1	2	3	4+	Van	Public Transit	Other Bus	2 Axle	3+ Axle	Motor- cycle	TOTAL OBS.	ACO	Counts
GP lanes	Q3/92	5961	1285	167	48	14	27	11	179	180	41	7913	1.24	12
	Q4/92	1280	243	17	3	3	1	3	54	37	2	1643	1.19	2
3	Q1/93	2522	597	7	0	1	16	4	64	106	4	3321	1.20	5
	Q2/93	1973	462	79	54	4	12	5	110	82	22	2803	1.31	4
	Q3/93	12096	2829	233	39	11	74	6	460	401	109	16258	1.23	24
	Q4/93	7391	1654	220	78	56	32	2	256	203	38	9930	1.25	16
	Q1/94	6829	1527	238	60	45	42	5	242	222	17	9227	1.25	14
	Q2/94	7754	1717	207	69	47	36	3	204	254	55	10346	1.24	17
														94

**SITE #73b. I-405 CENTRAL - NE 4th Street**

**▲ ACO mainline NB & SB-am & pm**

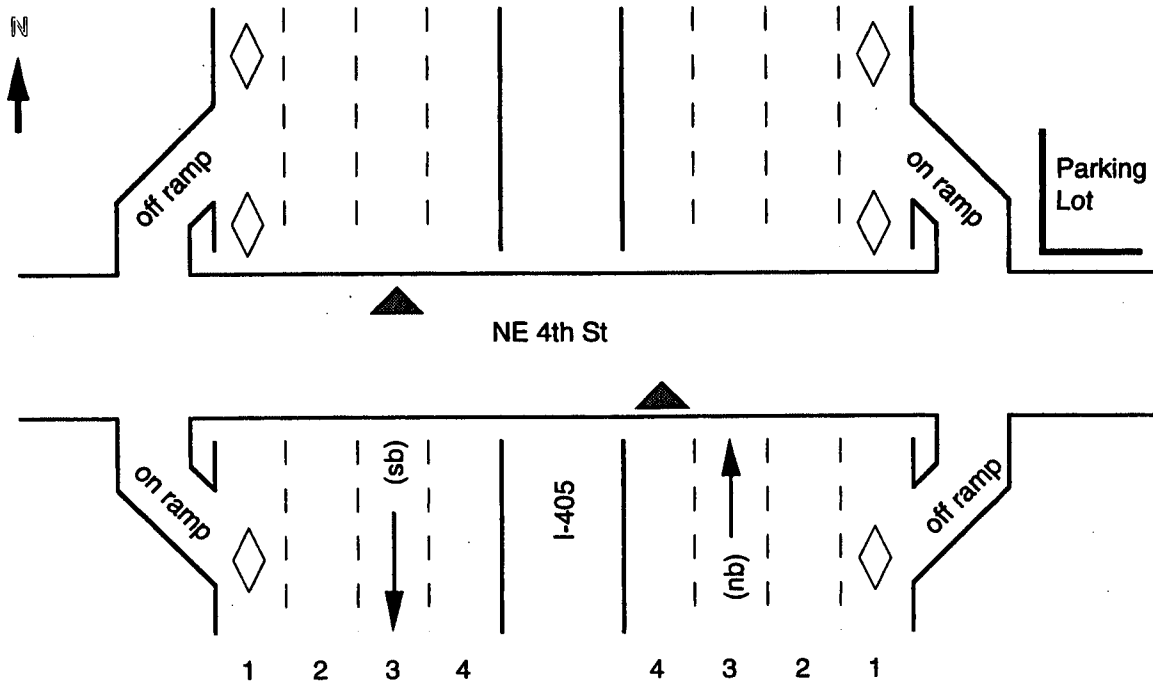

**a.m. northbound**

	Qtr.	1	2	3	4+	Van	Public Transit	Other Bus	2 Axle	3+	Motor- cycle	TOTAL OBS.	ACO	Counts	
HOV lanes 1	Q3/94	131	446	40	16	6	24	2	9	3	30	707	1.91*	5	
	Q4/94	55	776	53	11	10	53	10	21	1	18	1008	2.02	7	
	Q1/95	148	756	57	14	29	65	9	13	9	12	1112	1.94*	8	
	Q2/95	427	1151	77	12	31	70	4	29	6	47	1854	1.81*	11	
	Q3/95	48	703	52	19	12	53	3	29	16	37	972	2.06	9	
	No observations conducted Q4/95 - Q2/96												-		
	Q3/96	167	1005	96	19	28	74	3	16	14	49	1471	1.98*	8	
	No observations conducted Q4/96 - Q1/97												-		
	Q2/97	325	1278	78	18	46	96	20	28	12	34	1935	1.88*	11	
	Q3/97	626	1341	100	21	71	76	5	36	30	47	2353	1.77*	10	
	No observations conducted Q4/97 - Q1/98												-		
	Q2/98	449	2053	225	40	63	120	19	176	24	62	3231	1.95*	18	
	<b>87</b>														

\* ACO low due to high percentage of violators observed during this quarter.



**I-405 CENTRAL - NE 4th Street**

**a.m. northbound**

	Qtr.	1	2	3	4+	Van	Public Transit	Other Bus	2 Axle	3+ Axle	Motor- cycle	TOTAL OBS.	ACO	Counts	
GP lanes 3	Q3/94	4273	357	41	22	7	6	1	151	301	29	5188	1.11	11	
	Q4/94	2040	119	7	0	1	1	2	71	138	0	2379	1.06	4	
	Q1/95	2791	126	9	1	0	6	2	116	204	4	3259	1.05	7	
	Q2/95	4901	131	9	6	2	1	1	121	259	8	5439	1.03	9	
	Q3/95	1358	109	5	8	6	2	0	71	127	5	1691	1.10	6	
	No observations conducted Q4/95 - Q2/96												-		
	Q3/96	4699	164	12	3	6	2	1	102	249	19	5257	1.04	9	
	No observations conducted Q4/96 - Q1/97												-		
	Q2/97	3163	211	16	1	8	1	0	125	238	9	3772	1.07	8	
	Q3/97	4962	230	24	3	9	1	1	129	272	20	5651	1.06	8	
	No observations conducted Q4/97 - Q1/98														
	Q2/98	7615	543	26	10	15	4	7	552	499	81	9352	1.08	14	
															76

**p.m. northbound**

	Qtr.	1	2	3	4+	Van	Public Transit	Other Bus	2 Axle	3+ Axle	Motor- cycle	TOTAL OBS.	ACO	Counts	
HOV lanes 1	Q3/94	38	464	89	22	11	4	1	3	3	24	659	2.16	3	
	Q4/94	101	1159	89	49	11	8	6	32	5	17	1477	2.07	8	
	Q1/95	237	1971	118	36	22	10	13	36	7	5	2455	1.98*	12	
	Q2/95	279	1952	181	17	14	6	4	28	2	24	2507	1.98*	9	
	Q3/95	474	1803	210	53	27	1	8	35	16	39	2666	1.94*	8	
	No observations conducted Q4/95 - Q2/96												-		
	Q3/96	242	1808	214	88	38	10	10	66	23	42	2541	2.07	12	
	No observations conducted Q4/96 - Q1/97												-		
	Q2/97	476	2528	141	22	30	10	8	23	9	48	3295	1.91	13	
	Q3/97	285	1819	291	86	24	20	15	33	11	49	2633	2.08	9	
	No observations conducted Q4/97 - Q1/98														
	Q2/98	520	3001	328	59	40	22	15	134	16	49	4184	1.98*	16	
															90
	GP lanes 3	Q3/94	5202	831	120	76	4	4	4	146	149	25	6561	1.21	12
Q4/94		2827	236	12	15	1	0	3	81	78	7	3260	1.10	6	
Q1/95		4716	206	14	8	5	0	1	98	116	3	5167	1.05	9	
Q2/95		3881	497	33	6	3	0	2	151	127	3	4703	1.13	7	
Q3/95		5144	223	31	11	4	0	0	106	146	16	5681	1.06	9	
No observations conducted Q4/95 - Q2/96												-			
Q3/96		3692	355	49	28	21	1	4	101	126	12	4389	1.13	11	
No observations conducted Q4/96 - Q1/97												-			
Q2/97		4683	613	21	32	15	0	0	106	77	7	5554	1.14	8	
Q3/97		4923	724	91	18	16	0	2	116	163	25	6078	1.17	10	
No observations conducted Q4/97 - Q1/98															
Q2/98		7480	762	34	13	15	1	3	297	271	20	8896	1.11	14	
															86

\* ACO low due to high percentage of violators observed during this quarter.

**I-405 Central - NE 4th Street**

**a.m. southbound**

	Qtr.	1	2	3	4+	Van	Public Transit	Other Bus	2 Axle	3+ Axle	Motor- cycle	TOTAL OBS.	ACO	Counts	
HOV lanes 1	Q3/94	51	323	34	20	6	21	2	5	2	19	483	2.06	7	
	Q4/94	25	366	32	9	3	4	5	7	3	7	461	2.06	7	
	Q1/95	51	441	31	4	4	7	5	5	1	8	557	1.98*	8	
	Q2/95	51	532	40	9	13	18	7	12	0	27	709	2.01	11	
	Q3/95	34	475	53	6	8	15	4	10	1	28	634	2.06	8	
	No observations conducted Q4/95 - Q2/96												-		
	Q3/96	74	1023	98	22	18	27	4	24	4	36	1330	2.06	9	
	No observations conducted Q4/96 - Q1/97												-		
	Q2/97	91	1029	109	8	29	28	17	16	3	21	1351	2.03	9	
	Q3/97	90	783	102	26	18	18	8	13	2	25	1085	2.07	7	
	No observations conducted Q4/97 - Q1/98												-		
	Q2/98	115	1276	172	24	37	46	14	104	1	21	1810	2.07	15	
															81
	GP lanes 3	Q3/94	6154	738	105	31	4	1	1	252	296	20	7602	1.15	22
		Q4/94	2001	165	6	1	0	0	0	107	145	1	2426	1.08	5
Q1/95		2660	208	17	4	0	0	0	89	96	4	3078	1.09	7	
Q2/95		3555	240	25	8	3	1	3	143	156	4	4138	1.08	10	
Q3/95		2959	132	20	4	2	1	1	105	127	7	3358	1.06	7	
No observations conducted Q4/95 - Q2/96												-			
Q3/96		2722	203	26	3	0	0	1	107	119	8	3189	1.09	6	
No observations conducted Q4/96 - Q1/97												-			
Q2/97		3962	320	25	7	6	2	3	126	131	8	4590	1.09	7	
Q3/97		4228	413	48	16	9	0	2	148	178	6	5048	1.12	10	
No observations conducted Q4/97 - Q1/98												-			
Q2/98		9070	709	45	9	18	9	2	638	400	17	10917	1.08	17	
															91

**I-405 Central - NE 4th Street**

**p.m. southbound**

	Qtr.	1	2	3	4+	Van	Public Transit	Other Bus	2 Axle	3+ Axle	Motor- cycle	TOTAL OBS.	ACO	Counts	
HOV lanes 1	Q3/94	68	545	83	29	14	22	3	10	1	30	805	2.11	5	
	Q4/94	88	718	91	28	52	87	2	8	0	22	1096	2.07	8	
	Q1/95	57	1438	129	44	59	121	15	19	3	16	1901	2.10	12	
	Q2/95	118	1028	95	22	18	67	14	18	3	10	1393	2.02	6	
	Q3/95	128	1036	139	35	44	70	5	10	4	36	1507	2.07	7	
	No observations conducted Q4/95 - Q2/96												-		
	Q3/96	189	2205	376	138	94	133	7	21	1	81	3245	2.17	12	
	No observations conducted Q4/96 - Q1/97												-		
	Q2/97	186	1478	271	141	35	87	2	15	1	23	2239	2.19	7	
	Q3/97	309	2476	220	59	39	96	14	28	3	74	3318	2.01	11	
	No observations conducted Q4/97 - Q1/98														
	Q2/98	357	2854	323	48	85	122	22	99	1	85	3996	2.02	12	
	<b>80</b>														
	GP lanes 3	Q3/94	5761	1152	214	107	28	18	6	182	231	42	7741	1.27	13
		Q4/94	2847	353	33	7	13	0	0	106	98	1	3458	1.14	6
Q1/95		4496	616	67	20	19	4	4	147	164	8	5545	1.16	9	
Q2/95		1961	373	15	7	1	3	3	95	118	3	2579	1.18	5	
Q3/95		4548	549	70	18	12	0	2	115	187	8	5509	1.14	9	
No observations conducted Q4/95 - Q2/96												-			
Q3/96		5301	599	91	29	17	1	2	135	234	12	6421	1.15	11	
No observations conducted Q4/96 - Q1/97												-			
Q2/97		3076	628	56	22	20	2	0	96	84	6	3990	1.21	7	
Q3/97		3867	599	56	30	7	5	4	162	208	8	4946	1.18	9	
No observations conducted Q4/97 - Q1/98															
Q2/98		4682	442	55	17	10	4	4	239	230	4	5687	1.12	10	
<b>79</b>															

\* Some observations with high percentage of violators

**SITE #81. I-405 NORTH - SR 908: Central Way/NE 85th**

- ACO on/ramp SB-am
- ACO off/ramp NB-pm

For period ending Q3/94: See following pages for data after HOV lane opened.

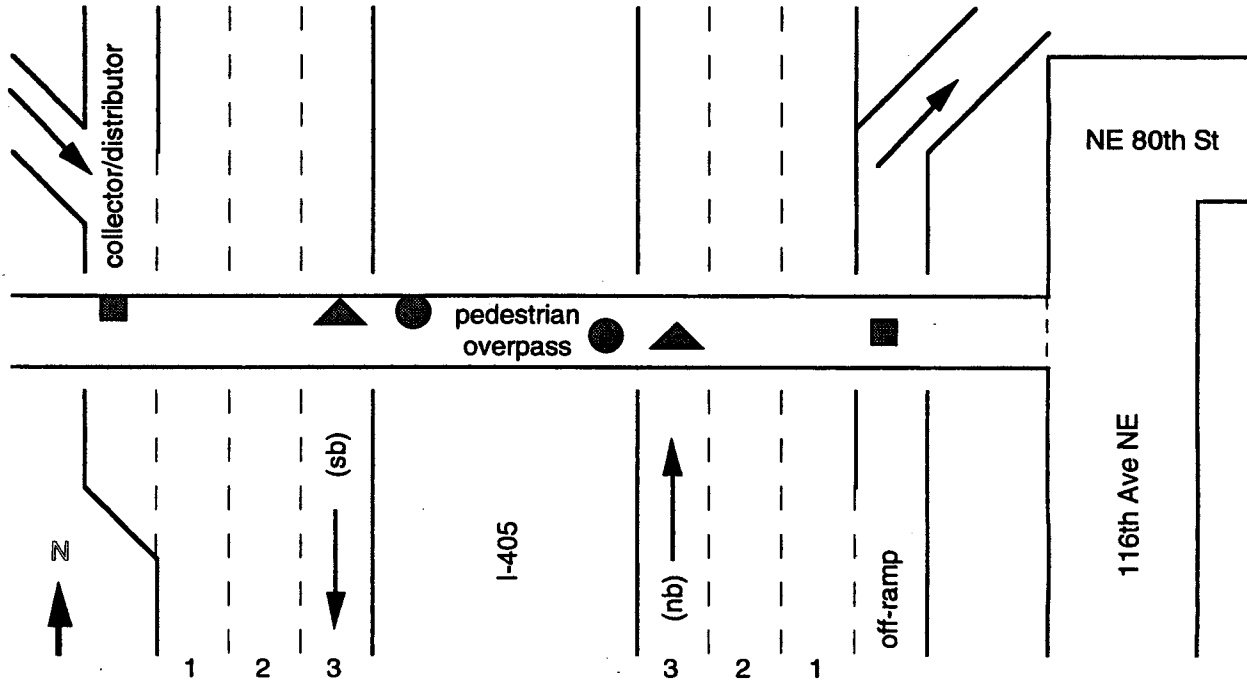

**a.m. southbound**

	Qtr.	1	2	3	4+	Van	Public Transit	Other Bus	2 Axle	3+ Axle	Motor- cycle	TOTAL OBS.	ACO	Counts
On ramp	Q3/92	4322	495	71	22	3	7	5	135	63	18	5141	1.14	12
	Q4/92	2356	211	32	5	0	2	8	25	25	1	2665	1.11	6
	Q1/93	4164	389	33	3	0	4	5	81	46	8	4733	1.10	12
	Q2/93	No observations											--	
	Q3/93	1590	181	19	1	2	5	2	49	37	4	1890	1.12	4
	Q4/93	No observations											--	
	Q1/94	3130	273	32	6	4	1	1	86	23	4	3560	1.10	11
	Q2/94	1954	253	34	5	3	6	3	40	44	7	2349	1.15	5
	Q3/94	1751	202	25	12	4	3	0	63	34	7	2101	1.15	5

**I-405 NORTH - SR 908: Central Way/NE 85th**

**p.m. northbound**

	Qtr.	1	2	3	4+	Van	Public Transit	Other Bus	2 Axle	3+ Axle	Motor- cycle	TOTAL OBS.	ACO	Counts	
Off ramp	Q3/92	7581	1351	254	124	16	71	3	114	47	44	9605	1.24	21	
	Q4/92	3047	342	60	12	10	27	5	41	20	8	3572	1.14	8	
	Q1/93	1539	262	24	19	4	13	2	33	5	8	1909	1.20	4	
	Q2/93	1544	286	44	19	3	4	0	36	6	6	1948	1.23	5	
	Q3/93	1347	270	47	13	1	5	0	20	8	10	1721	1.24	5	
	Q4/93	2566	445	77	35	9	23	3	47	54	8	3267	1.23	6	
	Q1/94	1768	319	49	12	10	19	1	33	11	0	2222	1.21	5	
	Q2/94	No observations											-		
	Q3/94	2733	567	98	73	8	26	1	43	22	23	3594	1.29	10	
														64	

**a.m. southbound**

	Qtr.	1	2	3	4+	Van	Public Transit	Other Bus	2 Axle	3+ Axle	Motor- cycle	TOTAL OBS.	ACO	Counts	
GP lanes 3	Q3/92	No observations											--		
	Q4/92	No observations											--		
	Q1/93	No observations											--		
	Q2/93	No observations											--		
	Q3/93	6533	691	66	21	1	31	1	181	153	21	7699	1.12	9	
	Q4/93	4995	371	32	36	5	30	8	151	165	2	5795	1.10	9	
	Q1/94	9742	917	56	17	9	42	4	248	233	9	11277	1.10	15	
	Q2/94	5538	496	35	20	2	34	3	167	203	11	6509	1.10	10	
	Q3/94	7939	795	68	26	8	35	6	254	219	23	9373	1.11	14	
														57	

**p.m. northbound**

	Qtr.	1	2	3	4+	Van	Public Transit	Other Bus	2 Axle	3+ Axle	Motor- cycle	TOTAL OBS.	ACO	Counts	
GP lanes 3	Q3/92	No observations											--		
	Q4/92	No observations											--		
	Q1/93	No observations											--		
	Q2/93	No observations											--		
	Q3/93	9950	1690	286	156	17	35	3	305	173	94	12709	1.23	16	
	Q4/93	6348	848	61	17	0	12	9	186	71	13	7565	1.14	10	
	Q1/94	5184	741	112	49	10	14	6	147	114	2	6379	1.18	9	
	Q2/94	10593	1522	179	121	17	33	8	227	209	39	12948	1.18	18	
	Q3/94	9259	1957	330	123	45	26	0	158	142	53	12093	1.26	15	
														68	

**I-405 North - SR 908: Central Way/NE 85th**

**Beginning Q4/94:** See preceding pages for data prior to HOV lane completion.

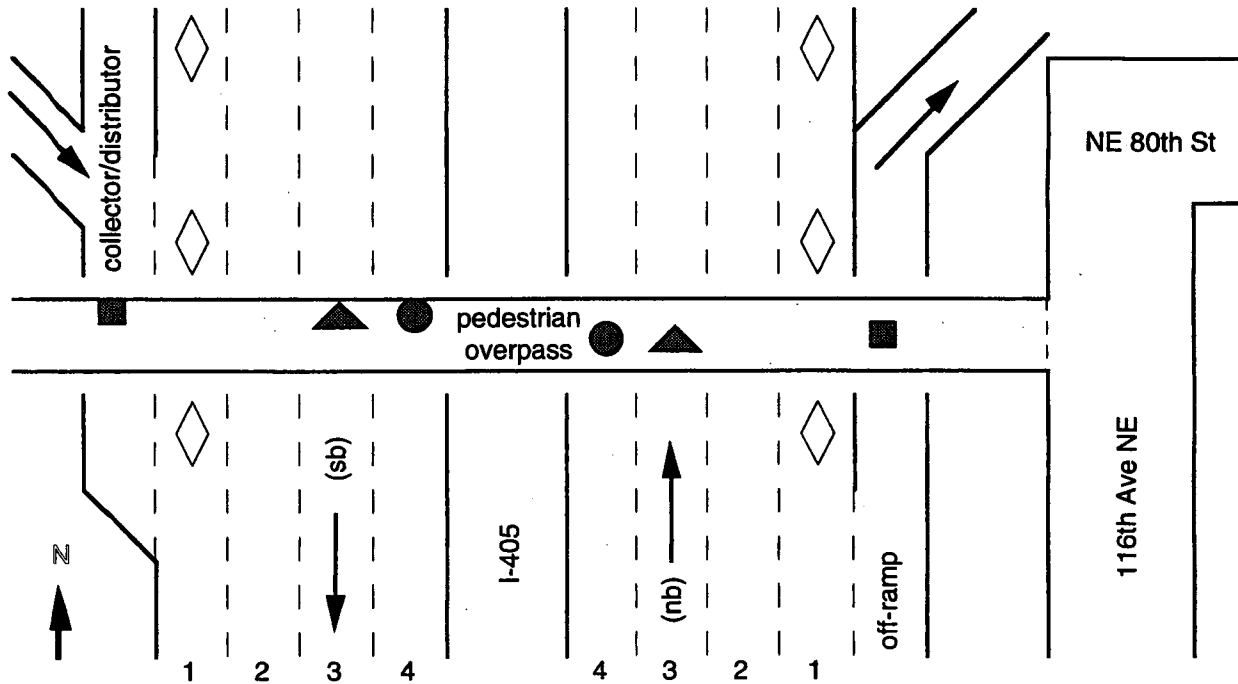

**Note:** In the winter, you can also park on the shoulder of each ramp in order to gain better visibility for ACO ramp counts. The northbound HOV lane opened to traffic on December 18, 1994. The southbound HOV lane is scheduled to open late summer/early fall, 1995.

**a.m. southbound**

	Qtr.	1	2	3	4+	Van	Public Transit	Other Bus	2 Axle	3+ Axle	Motor- cycle	TOTAL ACO OBS.	ACO Counts	
On ramp	Q4/94	3163	295	33	11	3	28	5	88	39	11	3676	1.11	7
	Q1/95	1219	78	1	5	2	1	5	38	27	3	1379	1.07	6
	Q2/95	3821	257	9	5	5	16	6	66	47	7	4239	1.07	11
	Q3/95	No observations											--	

24

**p.m. northbound**

	Qtr.	1	2	3	4+	Van	Public Transit	Other Bus	2 Axle	3+ Axle	Motor- cycle	TOTAL ACO OBS.	ACO Counts	
Off ramp	Q4/94	3379	327	33	23	18	39	2	72	29	9	3931	1.12	9
	Q1/95	1726	246	23	4	7	2	0	23	17	0	2048	1.15	5
	Q2/95	2619	411	47	15	2	1	0	39	15	7	3156	1.18	9
	Q3/95	No observations											--	

23

**I-405 North - SR 908: Central Way/NE 85th**

**a.m. southbound**

	Qtr.	1	2	3	4+	Van	Public Transit	Other Bus	2 Axle	3+ Axle	Motor- cycle	TOTAL OBS.	ACO	Counts
HOV lanes 1	Q3/95	222	583	17	8	8	26	7	19	9	24	923	1.77*	7
	No observations conducted Q4/95 - Q2/96												-	
	Q3/96	81	1956	98	38	32	61	8	35	3	74	2386	2.05	9
	No observations conducted Q4/96 - Q1/97												-	
	Q2/97	215	2228	108	20	58	62	6	27	3	65	2792	1.98*	9
	Q3/97	155	3089	229	58	82	86	4	28	5	95	3831	2.06	11
	No observations conducted Q4/97 - Q1/98												-	
	Q2/98	678	4687	399	57	84	119	51	305	23	106	6519	1.97*	17
	53													
	GP lanes 3	Q4/94	6957	688	71	9	9	25	5	171	209	13	8157	1.11
Q1/95		6290	942	72	8	3	18	5	164	203	11	7716	1.15	12
Q2/95		10103	731	41	11	17	48	4	301	408	37	11701	1.08	20
Q3/95		1680	78	4	3	1	2	0	51	111	7	1937	1.05	7
No observations conducted Q4/95 - Q2/96												-		
Q3/96		2994	68	2	2	0	1	0	67	98	4	3236	1.03	7
No observations conducted Q4/96 - Q1/97												-		
Q2/97		4747	140	8	0	2	0	3	124	178	1	5203	1.03	7
Q3/97		6645	151	17	6	0	1	3	167	218	8	7216	1.03	10
No observations conducted Q4/97 - Q1/98												-		
Q2/98	7138	207	9	10	6	8	3	509	294	4	8188	1.03	12	
88														

\* High number of violators in ALL counts in one section.

**I-405 North - SR 908: Central Way/NE 85th**

**p.m. northbound**

	Qtr.	1	2	3	4+	Van	Public Transit	Other Bus	2 Axle	3+ Axle	Motor- cycle	TOTAL OBS.	ACO	Counts	
HOV lanes 1	Q1/95	314	2555	269	117	32	89	12	67	10	31	3496	2.07	12	
	Q2/95	382	1493	129	30	13	34	11	56	1	15	2164	1.91*	6	
	Q3/95	697	2725	437	139	74	56	6	58	6	97	4295	2.01	9	
	No observations conducted Q4/95 - Q2/96												-		
	Q3/96	261	2544	264	76	54	45	14	44	6	70	3378	2.05	9	
	No observations conducted Q4/96 - Q1/97												-		
	Q2/97	310	1437	148	26	43	47	11	13	3	20	2058	1.95*	5	
	Q3/97	310	1848	278	134	89	39	12	43	7	33	2793	2.10	7	
	No observations conducted Q4/97 - Q1/98												-		
	Q2/98	1312	4098	461	111	129	113	42	226	19	49	6560	1.90	17	
															65
	GP lanes 3	Q4/94	8490	990	108	26	5	15	4	184	162	9	9993	1.13	14
Q1/95		4443	276	15	10	3	0	0	158	102	2	5009	1.07	7	
Q2/95		3863	467	34	8	0	0	2	106	87	10	4577	1.13	6	
Q3/95		6111	541	89	28	4	0	0	107	117	28	7025	1.12	9	
No observations conducted Q4/95 - Q2/96												-			
Q3/96		4688	338	35	15	7	2	2	84	87	8	5266	1.09	7	
No observations conducted Q4/96 - Q1/97												-			
Q2/97		1886	179	10	2	4	1	1	47	28	3	2161	1.10	3	
Q3/97		5928	784	81	63	13	1	1	114	124	18	7127	1.17	10	
No observations conducted Q4/97 - Q1/98												-			
Q2/98		8768	674	47	49	8	1	3	301	208	19	9578	1.10	13	
															69

\* High number of violators in ALL counts in one section.



**SITE #88. I-405 NORTH: Juanita - Woodinville Way/NE 160th**

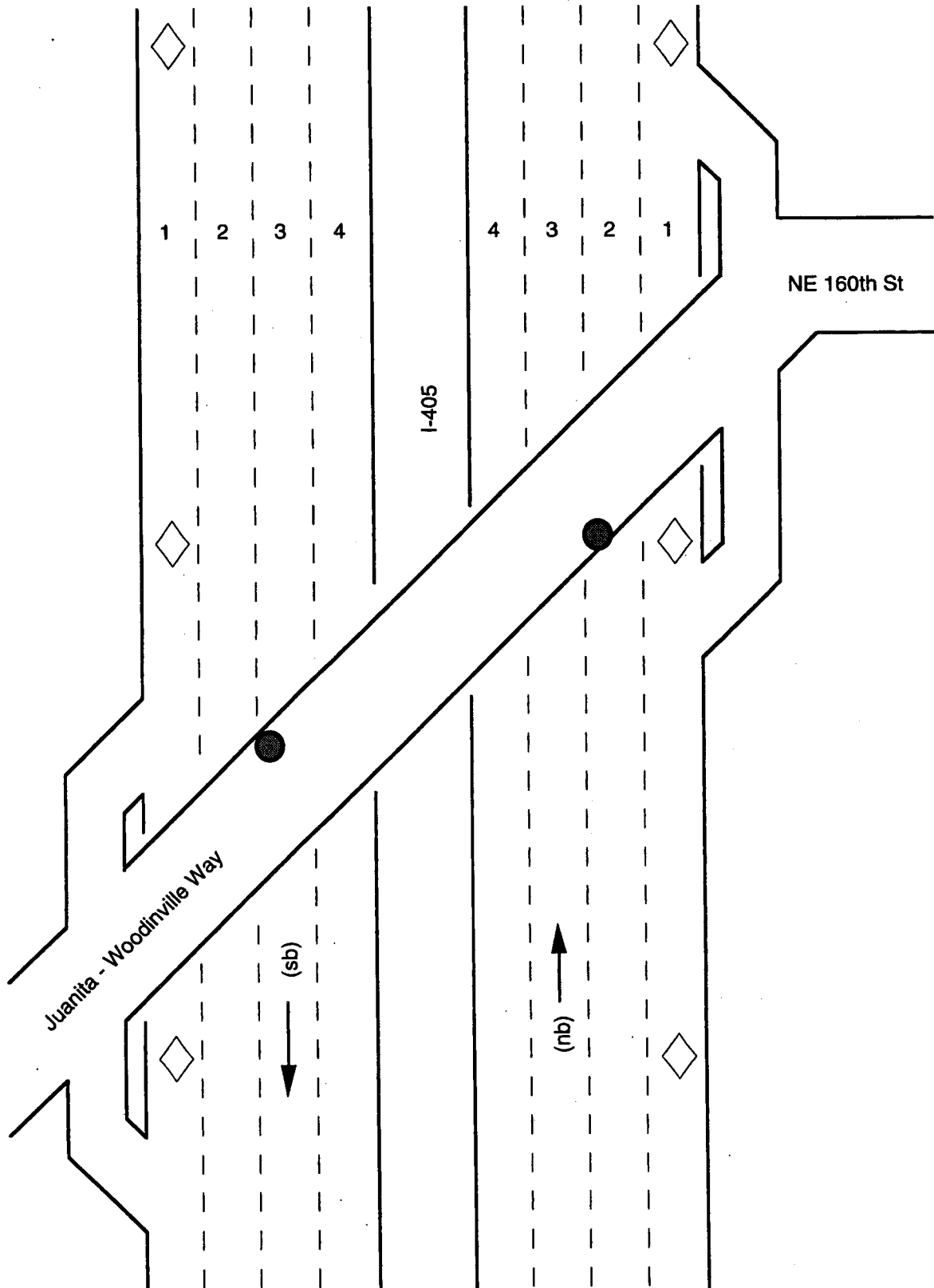

**Note:** This is a new site added Q2/98.

**I-405 North: Juanita - Woodinville Way/NE 160th**

**a.m. southbound**

	Qtr.	1	2	3	4+	Van	Public Transit	Other Bus	2 Axle	3+ Axle	Motor- cycle	TOTAL OBS.	ACO	Counts
HOV lanes 1	Q2/98	139	2576	203	16	94	33	17	274	8	44	3404	2.03	14
														14

	Qtr.	1	2	3	4+	Van	Public Transit	Other Bus	2 Axle	3+ Axle	Motor- cycle	TOTAL OBS.	ACO	Counts
GP lanes 3	Q2/98	7491	510	43	9	14	1	3	473	378	10	8932	1.08	14
														14

**a.m. northbound**

	Qtr.	1	2	3	4+	Van	Public Transit	Other Bus	2 Axle	3+ Axle	Motor- cycle	TOTAL OBS.	ACO	Counts
HOV lanes 1	Q2/98	42	310	39	11	0	11	4	22	11	3	453	2.05	7
														7

	Qtr.	1	2	3	4+	Van	Public Transit	Other Bus	2 Axle	3+ Axle	Motor- cycle	TOTAL OBS.	ACO	Counts
GP lanes 3	Q2/98	2307	307	8	10	4	6	0	297	179	5	3123	1.13	8
														8

**I-405 North: Juanita - Woodinville Way/NE 160th**

**p.m. southbound**

	Qtr.	1	2	3	4+	Van	Public Transit	Other Bus	2 Axle	3+ Axle	Motor- cycle	TOTAL OBS.	ACO	Counts
HOV lanes 1	Q2/98	90	1125	18	0	17	36	2	29	6	12	1335	1.94*	11

	Qtr.	1	2	3	4+	Van	Public Transit	Other Bus	2 Axle	3+ Axle	Motor- cycle	TOTAL OBS.	ACO	Counts
GP lanes 3	Q2/98	3106	682	57	19	5	1	1	129	111	5	4116	1.22	7

**p.m. northbound**

	Qtr.	1	2	3	4+	Van	Public Transit	Other Bus	2 Axle	3+ Axle	Motor- cycle	TOTAL OBS.	ACO	Counts
HOV lanes 1	Q2/98	1091	3157	436	121	103	25	22	317	87	35	5394	1.92*	13

	Qtr.	1	2	3	4+	Van	Public Transit	Other Bus	2 Axle	3+ Axle	Motor- cycle	TOTAL OBS.	ACO	Counts
GP lanes 3	Q2/98	4718	402	36	21	8	2	0	278	123	3	5591	1.10	12

\*AVO low due to high number of violators observed during this quarter.

**Vehicle Occupancy (ACO) Sites  
(Outlying Locations)**

**SITE #91. I-5 NORTH @ 112th SE- Everett**

ACO mainline SB-am  
 ACO mainline SB-pm  
 ACO mainline NB-am  
 ACO mainline NB-pm

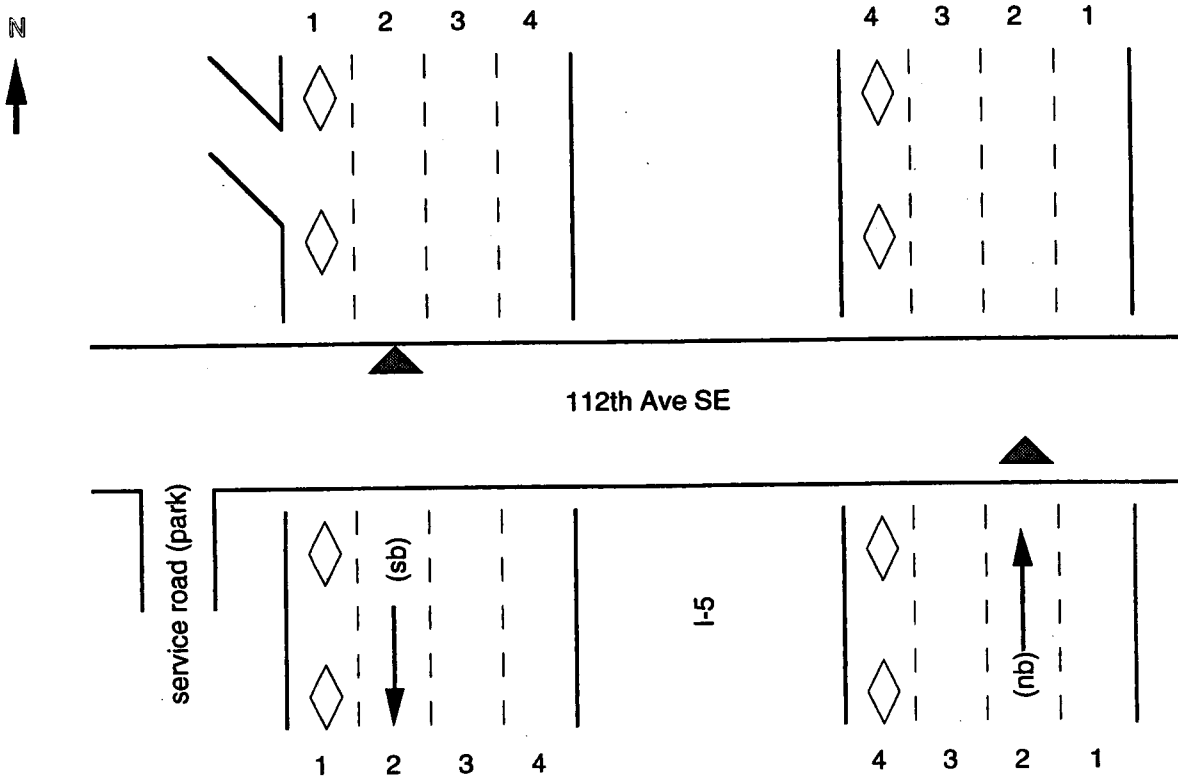

**a.m. northbound**

	Qtr.	1	2	3	4+	Van	Public Transit	Other Bus	2 Axle	3+ Axle	Motor- cycle	TOTAL OBS.	ACO	Counts
HOV	Q2/98	58	718	107	47	14	1	14	21	1	19	1000	2.16	7
1														7
GP	Q3/93	2418	407	72	51	6	1	3	97	112	15	3182	1.24	4
3	Q4/93	2021	121	23	11	1	0	4	51	64	3	2299	1.09	6
	Q1/94	4746	449	53	45	15	5	17	153	212	9	5704	1.13	12
	Q2/94	5738	540	67	35	15	4	16	154	301	29	6899	1.12	18
	Q3/94	6035	821	92	56	35	4	11	172	316	31	7573	1.17	13
	Q4/94	4938	386	29	2	15	5	10	118	197	0	5700	1.08	10
	Q1/95	4413	396	31	18	9	1	17	128	206	3	5222	1.11	10
	Q2/95	8713	662	65	15	55	14	23	172	408	19	10146	1.09	18
	Q3/95	894	54	4	2	5	1	2	56	90	6	1112	1.07	5
No observations conducted Q4/95 - Q1/98														
	Q2/98	9364	976	111	40	51	57	45	493	547	13	11697	1.13	19

**I-5 North@ 112th SE - Everett**

**p.m. northbound**

	Qtr.	1	2	3	4+	Van	Public Transit	Other Bus	2 Axle	3+ Axle	Motor- cycle	TOTAL OBS.	ACO	Counts
HOV 1	Q2/98	45	276	84	26	20	1	3	18	0	9	482	2.27	3
														3
GP 3	Q3/93	4318	1278	296	203	12	7	9	159	182	50	6514	1.41	8
	Q4/93	2086	653	90	34	9	0	5	52	72	1	3002	1.33	5
	Q1/94	6399	1949	141	100	9	4	38	133	182	22	8977	1.30	5
	Q2/94	4930	1249	166	81	18	5	18	168	192	26	6853	1.29	14
	Q3/94	7290	2006	277	199	13	4	18	243	269	54	10373	1.33	16
	Q4/94	7428	1208	105	75	23	8	24	173	235	27	9306	1.19	14
	Q1/95	6021	1296	108	85	13	9	17	150	211	11	7921	1.24	10
	Q2/95	6436	1774	155	48	14	12	50	195	341	30	9055	1.27	13
	Q3/95	3536	720	71	27	21	2	3	77	90	28	4575	1.22	6
	No observations conducted Q4/95 - Q1/98													
	Q2/98	14457	3519	462	154	79	47	80	649	590	61	20098	1.27	28
														119

**a.m. southbound**

	Qtr.	1	2	3	4+	Van	Public Transit	Other Bus	2 Axle	3+ Axle	Motor- cycle	TOTAL OBS.	ACO	Counts
HOV 1	Q2/98	425	961	110	36	18	48	36	77	34	19	1764	1.84*	13
														13
GP 3	Q3/93	4341	752	102	27	0	14	11	204	254	22	5727	1.20	12
	Q4/93	2279	275	16	8	0	1	2	43	47	5	2676	1.13	4
	Q1/94	6504	787	46	6	4	8	9	252	264	14	7894	1.12	14
	Q2/94	8642	1160	132	53	12	35	64	274	465	27	10864	1.16	20
	Q3/94	6878	960	133	116	12	16	7	160	265	35	8582	1.20	15
	Q4/94	3197	388	37	17	4	5	17	115	205	4	3989	1.14	10
	Q1/95	3749	571	39	9	6	5	17	110	235	5	4745	1.16	10
	Q2/95	4995	251	15	11	12	16	11	108	291	21	5731	1.06	14
	Q3/95	828	40	4	3	1	5	7	48	99	3	1038	1.07	5
	No observations conducted Q4/95 - Q1/98													
	Q2/98	5596	587	52	21	7	4	24	455	486	18	7250	1.12	12
														116

**I-5 North@ 112th SE - Everett**

**p.m. southbound**

	Qtr.	1	2	3	4+	Van	Public Transit	Other Bus	2 Axle	3+ Axle	Motor- cycle	TOTAL OBS.	ACO	Counts
HOV	Q2/98	635	3090	412	137	100	69	24	130	215	79	4891	2.02	17
1														17
GP	Q3/93	6208	1464	246	137	22	12	15	185	209	40	8538	1.30	13
3	Q4/93	4499	1080	158	59	21	11	10	104	193	3	6138	1.27	10
	Q1/94	8248	2492	400	135	60	12	19	158	209	19	11752	1.33	8
	Q2/94	11899	2794	359	136	74	25	38	294	355	43	16017	1.26	26
	Q3/94	9935	2548	385	286	38	15	25	359	392	64	14047	1.32	19
	Q4/94	9898	1417	118	78	54	14	16	235	359	23	12212	1.17	15
	Q1/95	11319	2324	284	129	81	17	23	255	347	25	14804	1.24	20
	Q2/95	6820	1737	185	125	35	15	11	230	286	26	9470	1.28	15
	Q3/95	2748	630	80	26	24	3	6	61	81	22	3681	1.25	6
	No observations conducted Q4/95 - Q1/98													
	Q2/98	6950	983	112	34	17	6	15	244	320	8	8689	1.16	12
														144

**SITE #92. I-5 SOUTH @ 70th E - Fife**

- ACO mainline SB-am
- ACO mainline SB-pm
- ACO mainline NB-am
- ACO mainline NB-pm

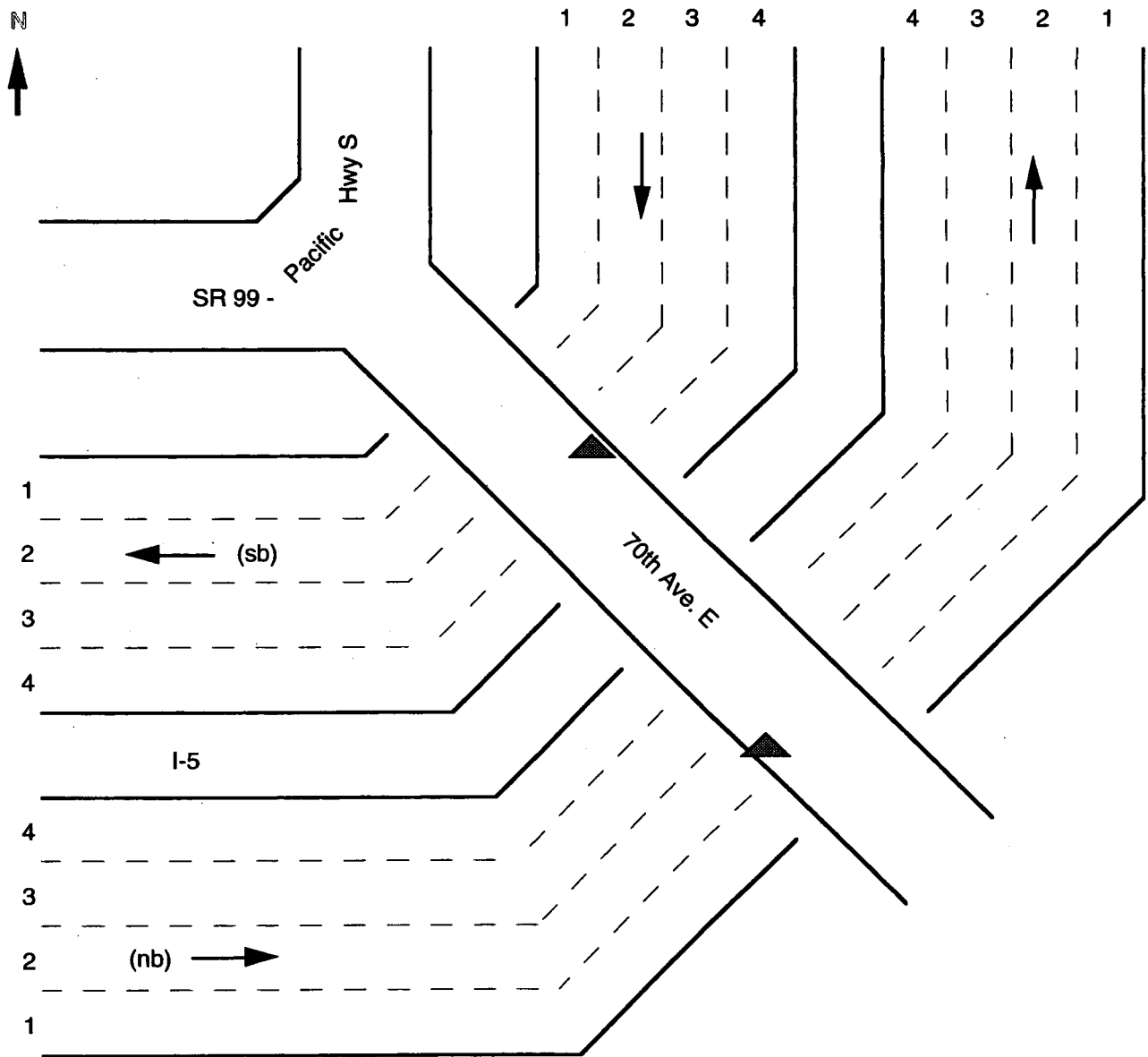



**I-5 South @ 70th E - Fife**

**a.m. southbound**

	Qtr.	1	2	3	4+	Van	Public Transit	Other Bus	2 Axle	3+ Axle	Motor- cycle	TOTAL OBS.	ACO	Counts
GP	Q3/93	1541	167	25	16	1	5	4	63	107	3	1932	1.15	5
Lanes	Q4/93	4747	564	41	17	14	6	7	176	345	1	5918	1.13	13
4	Q1/94	3929	435	45	23	5	2	12	170	314	6	4941	1.14	14
	Q2/94	4619	407	20	63	6	6	14	160	299	7	5601	1.13	13
	Q3/94	7765	490	13	43	14	15	3	319	594	38	9295	1.08	21
	Q4/94	2629	245	13	9	2	10	8	128	250	1	3295	1.10	9
	Q1/95	3589	225	26	54	4	18	1	130	147	2	4195	1.12	11
	Q2/95	5067	365	25	23	8	12	6	155	351	5	6017	1.09	14
	Q3/95	No observations conducted Q3/95 - Q1/98										--		
	Q2/98	5309	669	65	22	35	29	21	312	466	19	6947	1.14	15

115

**p.m. southbound**

	Qtr.	1	2	3	4+	Van	Public Transit	Other Bus	2 Axle	3+ Axle	Motor- cycle	TOTAL OBS.	ACO	Counts
GP	Q3/93	2708	615	33	2	2	5	0	71	119	22	3577	1.20	5
Lanes	Q4/93	7463	1877	166	57	54	11	12	208	405	14	10267	1.25	16
4	Q1/94	6561	1496	130	65	16	17	8	220	362	4	8979	1.24	14
	Q2/94	6792	1324	154	144	27	12	7	192	576	22	9250	1.25	17
	Q3/94	7817	1448	70	113	20	9	3	155	436	35	10106	1.21	15
	Q4/94	9579	1126	88	78	25	18	7	198	419	8	11546	1.14	17
	Q1/95	9826	1076	41	111	18	6	4	187	364	15	11648	1.14	17
	Q2/95	9199	1023	39	124	15	8	6	189	282	41	10926	1.14	20
	Q3/95	No observations conducted Q3/95 - Q1/98										--		
	Q2/98	13369	3167	278	67	43	30	35	461	684	39	18173	1.23	23

144

**I-5 South @ 70th E - Fife**

**a.m. northbound**

	Qtr.	1	2	3	4+	Van	Public Transit	Other Bus	2 Axle	3+ Axle	Motor- cycle	TOTAL OBS.	ACO	Counts
GP	Q3/93	3938	501	59	49	8	10	11	143	387	19	<b>5125</b>	<b>1.17</b>	<b>11</b>
Lanes	Q4/93	4533	688	73	23	16	8	9	151	314	10	<b>5825</b>	<b>1.17</b>	<b>11</b>
4	Q1/94	3911	451	52	16	3	12	13	145	438	2	<b>5043</b>	<b>1.14</b>	<b>18</b>
	Q2/94	6468	493	71	50	12	16	9	164	455	14	<b>7752</b>	<b>1.11</b>	<b>14</b>
	Q3/94	6793	783	37	45	2	19	15	195	502	22	<b>8413</b>	<b>1.13</b>	<b>17</b>
	Q4/94	5200	814	49	34	6	11	8	147	411	2	<b>6682</b>	<b>1.17</b>	<b>13</b>
	Q1/95	3990	260	14	22	7	4	10	115	228	4	<b>4654</b>	<b>1.08</b>	<b>11</b>
	Q2/95	4639	291	22	35	5	8	15	142	508	17	<b>5682</b>	<b>1.09</b>	<b>13</b>
	Q3/95	No observations conducted Q3/95 - Q1/98										--		
	Q2/98	6368	1163	94	26	22	11	14	387	557	12	<b>8654</b>	<b>1.19</b>	<b>15</b>

123

**p.m. northbound**

	Qtr.	1	2	3	4+	Van	Public Transit	Other Bus	2 Axle	3+ Axle	Motor- cycle	TOTAL OBS.	ACO	Counts
GP	Q3/93	1901	704	50	4	4	0	4	80	111	21	<b>2879</b>	<b>1.31</b>	<b>5</b>
Lanes	Q4/93	5893	1714	209	126	25	17	17	215	415	18	<b>8649</b>	<b>1.32</b>	<b>17</b>
4	Q1/94	6135	1605	179	22	13	12	10	196	329	8	<b>8509</b>	<b>1.26</b>	<b>14</b>
	Q2/94	3714	767	123	90	4	10	7	171	404	19	<b>5309</b>	<b>1.28</b>	<b>12</b>
	Q3/94	10180	1519	75	116	3	12	16	325	572	40	<b>12858</b>	<b>1.17</b>	<b>25</b>
	Q4/94	8100	824	56	71	2	22	12	217	403	8	<b>9715</b>	<b>1.13</b>	<b>17</b>
	Q1/95	5975	621	28	85	1	17	9	166	303	4	<b>7209</b>	<b>1.14</b>	<b>13</b>
	Q2/95	7962	629	44	141	2	18	6	267	336	11	<b>9416</b>	<b>1.13</b>	<b>19</b>
	Q3/95	No observations conducted Q3/95 - Q1/98										--		
	Q2/98	7348	2016	160	63	25	20	19	360	443	35	<b>10489</b>	<b>1.26</b>	<b>16</b>

138

**SITE #93. I-5 @ Tacoma Mall - Tacoma**

ACO mainline SB-am  
 ACO mainline SB-pm  
 ACO mainline NB-am  
 ACO mainline NB-pm

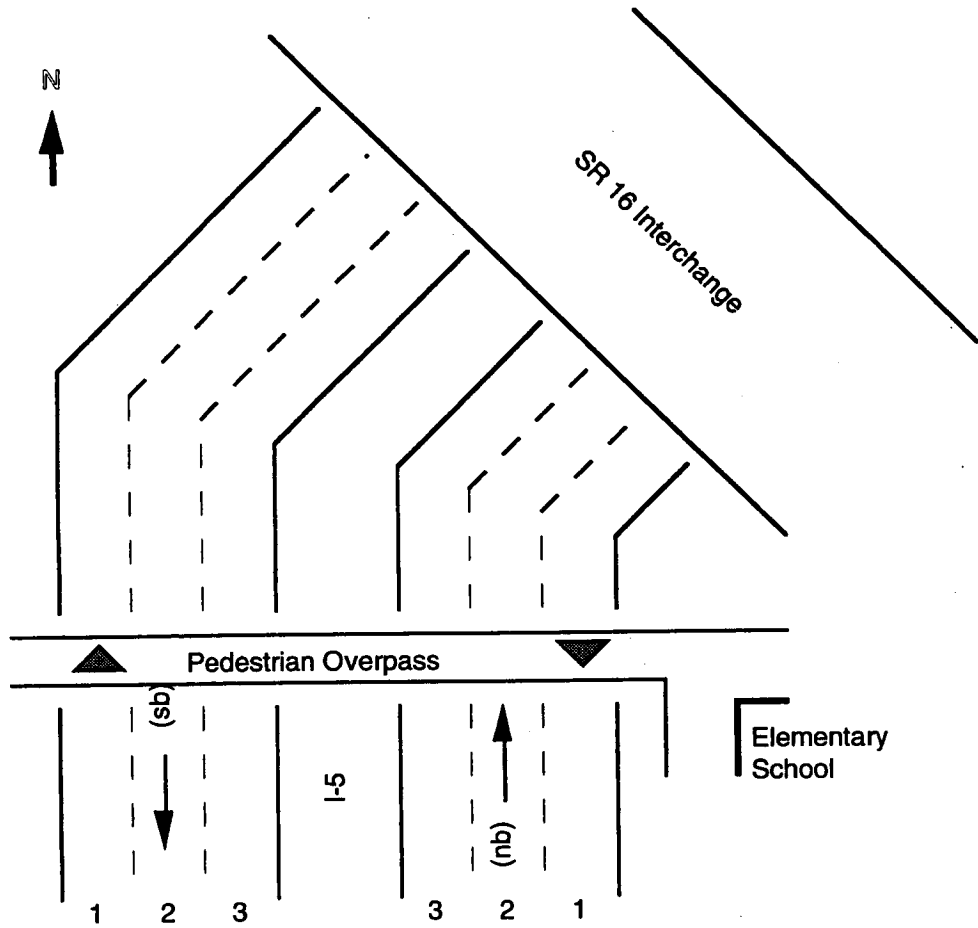

**a.m. southbound**

	Qtr.	1	2	3	4+	Van	Public Transit	Other Bus	2 Axle	3+ Axle	Motor- cycle	TOTAL OBS.	ACO Counts	
GP	Q3/93	No observations											-	
3	Q4/93	6844	1330	90	28	37	31	16	322	596	8	9302	1.19	28
	Q1/94	2633	262	51	21	0	3	9	119	249	2	3349	1.15	10
	Q2/94	5028	409	18	27	8	27	14	268	558	10	6367	1.10	15
	Q3/94	6275	700	25	54	9	37	15	295	541	30	7981	1.13	20
	Q4/94	6887	400	13	31	0	39	10	230	402	4	8016	1.07	16
	Q1/95	6533	294	16	44	12	45	12	218	347	1	7522	1.07	16
	Q2/95	4794	122	6	11	8	38	12	207	316	5	5519	1.03	15
	Q3/95	No observations											--	

**I-5 @ Tacoma Mall - Tacoma**

**p.m. southbound**

	Qtr.	1	2	3	4+	Van	Public Transit	Other Bus	2 Axle	3+ Axle	Motor- cycle	TOTAL OBS.	ACO	Counts
GP	Q3/93	1848	628	59	31	5	7	5	76	151	7	2817	1.33	4
3	Q4/93	4967	1349	117	56	20	15	14	128	283	12	6961	1.27	12
	Q1/94	6243	1697	196	24	22	17	13	156	359	4	8731	1.27	15
	Q2/94	3793	1249	259	159	3	9	8	152	195	21	5848	1.42	9
	Q3/94	7628	1806	51	87	4	12	5	154	407	30	10184	1.23	15
	Q4/94	8671	1215	45	42	2	22	7	158	398	7	10567	1.14	17
	Q1/95	8973	505	35	67	4	10	19	157	298	6	10074	1.08	19
	Q2/95	7707	320	16	89	4	10	9	133	250	14	8552	1.08	15
	Q3/95	No observations											--	

106

**a.m. northbound**

	Qtr.	1	2	3	4+	Van	Public Transit	Other Bus	2 Axle	3+ Axle	Motor- cycle	TOTAL OBS.	ACO	Counts
GP	Q3/93	2097	361	29	9	6	7	4	51	144	13	2721	1.18	5
3	Q4/93	5857	1018	85	23	38	33	5	165	447	9	7680	1.18	17
	Q1/94	4439	691	85	30	8	8	18	145	429	10	5863	1.18	17
	Q2/94	5686	525	21	49	9	55	19	188	714	13	7279	1.12	15
	Q3/94	9617	1094	23	67	2	31	10	264	804	28	11940	1.13	24
	Q4/94	8596	665	15	45	4	19	6	163	506	5	10024	1.09	18
	Q1/95	3953	227	6	38	0	5	3	77	188	1	4498	1.09	8
	Q2/95	7900	381	16	51	2	31	14	142	507	17	9061	1.07	18
	Q3/95	No observations											--	

122

**p.m. northbound**

	Qtr.	1	2	3	4+	Van	Public Transit	Other Bus	2 Axle	3+ Axle	Motor- cycle	TOTAL OBS.	ACO	Counts
GP	Q3/93	1912	599	105	51	3	3	2	74	164	0	2913	1.36	7
3	Q4/93	3648	1186	167	33	16	6	77	151	253	5	5476	1.32	12
	Q1/94	4357	1354	109	53	5	10	16	193	299	4	6400	1.30	14
	Q2/94	5121	1396	102	131	11	16	15	179	420	40	7431	1.30	15
	Q3/94	3496	934	59	93	3	7	8	125	282	33	5040	1.29	11
	Q4/94	9118	1493	61	146	3	47	15	258	456	18	11615	1.31	22
	Q1/95	7980	673	19	70	3	25	6	188	306	6	9276	1.11	18
	Q2/95	3467	214	6	37	0	3	7	83	109	1	3927	1.09	10
	Q3/95	No observations											--	

109

**SITE #94. SR 16 @ Tacoma Narrows Bridge - Tacoma**

ACO mainline EB-am  
 ACO mainline EB-pm  
 ACO mainline WB-pm

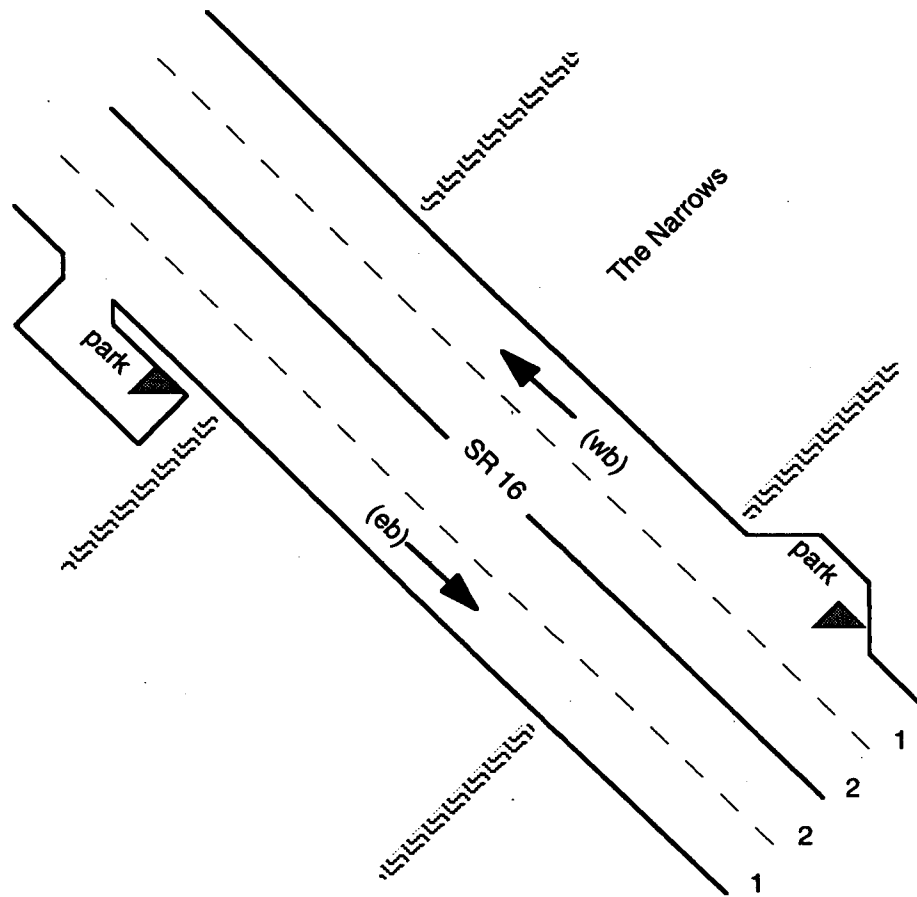

**a.m. eastbound**

	Qtr.	1	2	3	4+	Van	Public Transit	Other Bus	2 Axle	3+ Axle	Motor- cycle	TOTAL ACO OBS.	Counts	
GP	Q3/93	2673	386	56	24	4	2	2	57	39	16	3259	1.18	4
2	Q4/93	22850	2897	221	101	39	7	27	315	396	26	26864	1.14	36
	Q1/94	7474	769	94	30	4	1	13	109	152	7	8653	1.13	11
	Q2/94	10073	785	29	48	4	14	7	148	167	27	11302	1.09	19
	Q3/94	15117	907	24	85	4	9	5	151	206	52	16560	1.08	20
	Q4/94	10626	769	33	21	3	8	8	86	109	14	11677	1.08	13
	Q1/95	11289	780	26	66	0	10	6	93	124	5	12399	1.09	17
	Q2/95	10049	610	20	66	3	8	3	74	77	18	10928	1.08	15
	Q3/95	No observations											--	

**SR 16 @ Tacoma Narrows Bridge - Tacoma**

**p.m. westbound**

	Qtr.	1	2	3	4+	Van	Public Transit	Other Bus	2 Axle	3+ Axle	Motor- cycle	TOTAL OBS.	ACO	Counts
GP	Q3/93	4176	853	146	56	19	3	3	65	40	30	5391	1.25	6
2	Q4/93	4064	824	126	70	6	4	9	60	38	12	5213	1.26	6
	Q1/94	6996	1450	168	96	5	2	10	116	64	5	8912	1.24	11
	Q2/94	9340	1828	94	157	5	16	6	97	102	62	11707	1.22	14
	Q3/94	10790	913	32	57	4	7	5	96	104	139	12147	1.10	14
	Q4/94	12000	1282	62	109	4	9	4	104	95	7	13676	1.13	16
	Q1/95	14267	1043	31	120	9	9	7	137	118	3	15744	1.10	23
	Q2/95	10275	665	27	103	4	3	5	65	42	4	11193	1.09	15
	Q3/95	No observations										--		

**SITE #95. SR 512 @ Ainsworth Ave. - Parkland**

ACO mainline WB-am  
ACO mainline EB-pm

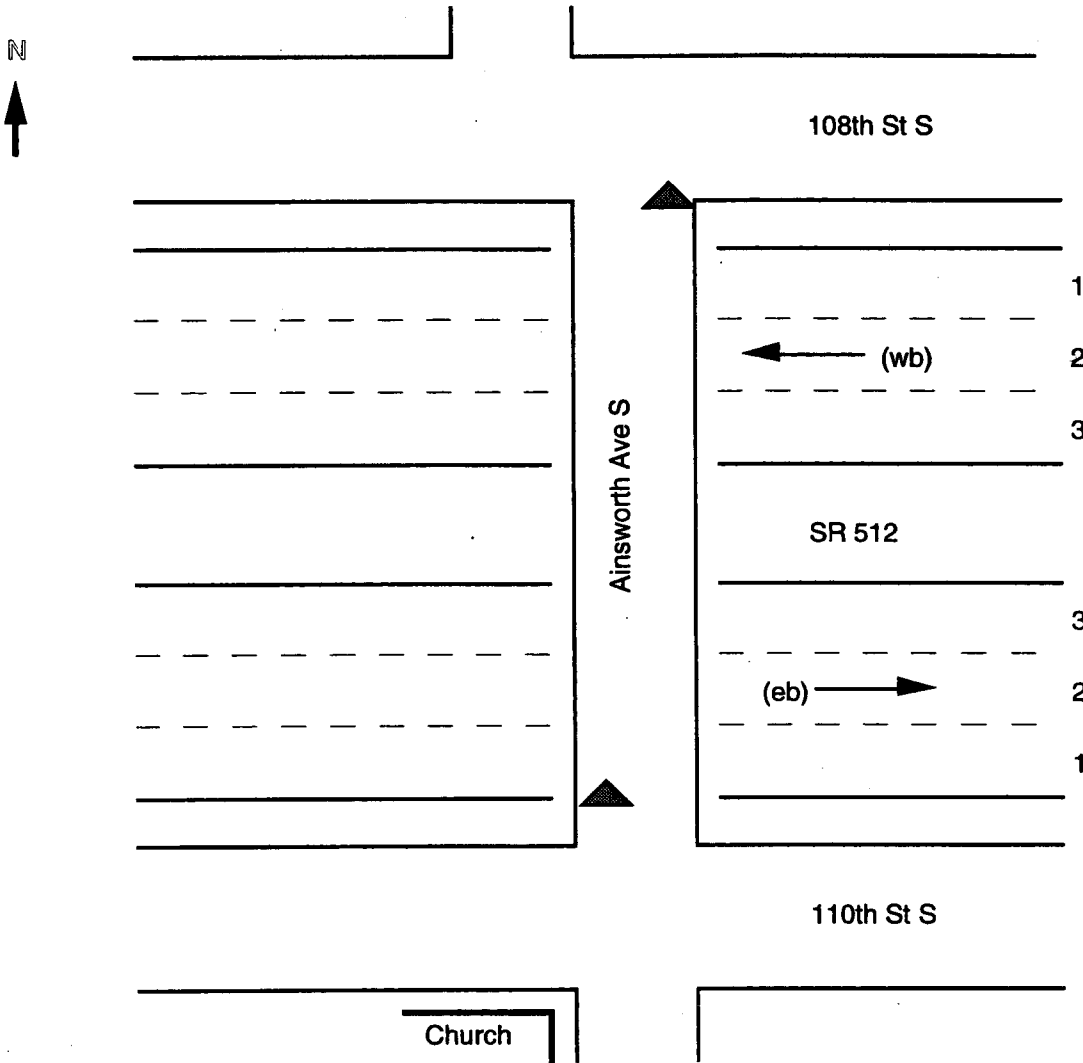

**a.m. westbound**

	Qtr.	1	2	3	4+	Van	Public Transit	Other Bus	2 Axle	3+ Axle	Motor- cycle	TOTAL OBS.	ACO	Counts
GP 3	Q3/93	2267	275	22	2	1	3	0	112	119	6	2807	1.13	6
	Q4/93	5179	558	40	7	2	8	4	161	224	7	6190	1.11	16
	Q1/94	2268	313	40	7	0	0	2	126	172	3	2931	1.16	10
	Q2/94	3748	290	21	14	0	4	3	146	226	11	4463	1.09	9
	Q3/94	7779	432	23	22	0	7	8	221	335	37	8864	1.07	19
	Q4/94	9067	768	39	64	5	7	4	258	304	7	10523	1.11	16
	Q1/95	6345	393	20	52	0	5	0	188	183	2	7188	1.09	12
	Q2/95	6150	257	6	52	0	0	3	178	185	9	6840	1.07	15
Q3/95	No observations											--		

**SR 512 @ Ainsworth Ave. - Parkland**

**p.m. eastbound**

	Qtr.	1	2	3	4+	Van	Public Transit	Other Bus	2 Axle	3+ Axle	Motor- cycle	TOTAL OBS.	ACO	Counts
GP	Q3/93	2830	822	148	54	2	2	4	125	96	23	4106	1.33	9
3	Q4/93	5944	1200	98	18	5	7	6	185	211	10	7684	1.20	17
	Q1/94	3164	687	79	22	1	5	6	125	117	8	4214	1.23	9
	Q2/94	2519	468	60	40	0	2	4	100	123	10	3326	1.23	7
	Q3/94	7591	843	37	73	1	6	3	166	207	22	8949	1.13	20
	Q4/94	8277	592	36	61	1	9	5	149	176	9	9315	1.10	18
	Q1/95	7942	499	24	50	0	9	2	211	214	9	8960	1.08	18
	Q2/95	5775	323	20	47	1	8	0	112	132	11	6429	1.08	16
	Q3/95	No observations										--		



**SITE #96. SR 410 @ East Valley Avenue - Sumner**

ACO mainline WB-am  
 ACO mainline EB-pm  
 ACO mainline WB-pm

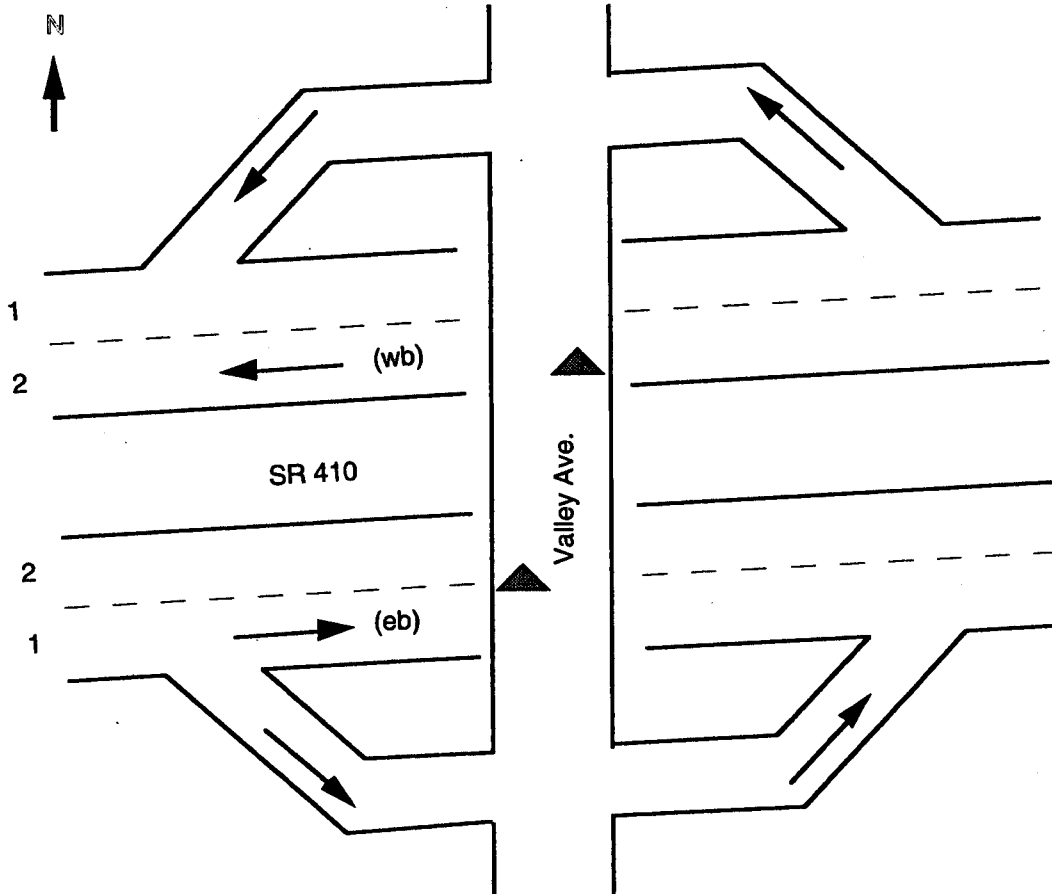

**a.m. westbound**

	Qtr.	1	2	3	4+	Van	Public Transit	Other Bus	2 Axle	3+ Axle	Motor- cycle	TOTAL OBS.	ACO	Counts	
GP 2	Q3/93	3494	478	54	14	1	2	4	103	79	14	4243	1.16	12	
	Q4/93	3200	460	37	10	6	3	6	62	73	5	3862	1.15	12	
	Q1/94	2335	309	29	9	1	0	3	51	70	3	2810	1.15	12	
	Q2/94	6705	830	52	34	1	0	6	147	139	29	7943	1.14	19	
	Q3/94	9781	955	14	22	2	0	7	201	235	42	11259	1.10	21	
	Q4/94	8379	642	19	20	0	6	7	153	235	4	9465	1.08	17	
	Q1/95	5008	342	27	52	0	4	8	95	142	1	5679	1.10	11	
	Q2/95	5699	165	1	16	31	8	4	85	109	9	6127	1.04	14	
	Q3/95	No observations											--		

**SR 410 @ East Valley Avenue - Sumner**

**p.m. eastbound**

	Qtr.	1	2	3	4+	Van	Public Transit	Other Bus	2 Axle	3+ Axle	Motor- cycle	TOTAL OBS.	ACO	Counts
GP	Q3/93	3166	802	151	50	4	1	3	82	67	11	4337	1.30	12
2	Q4/93	3426	897	111	19	8	5	4	83	74	4	4631	1.26	12
	Q1/94	2811	571	70	16	1	1	3	62	57	10	3602	1.22	5
	Q2/94	1367	177	13	3	3	0	0	29	26	9	1627	1.14	4
	Q3/94	8974	1213	67	89	16	2	7	142	167	121	10798	1.16	22
	Q4/94	8377	708	29	42	10	3	14	109	146	10	9448	1.10	16
	Q1/95	9336	880	54	94	17	2	11	164	163	5	10726	1.12	17
	Q2/95	7131	524	21	41	10	2	6	105	97	2	7959	1.09	15
	Q3/95	No observations										--		

**SITE #97. SR 167 @ 37th NW - Auburn**

ACO mainline NB-am  
 ACO mainline NB-pm  
 ACO mainline SB-am  
 ACO mainline SB-pm

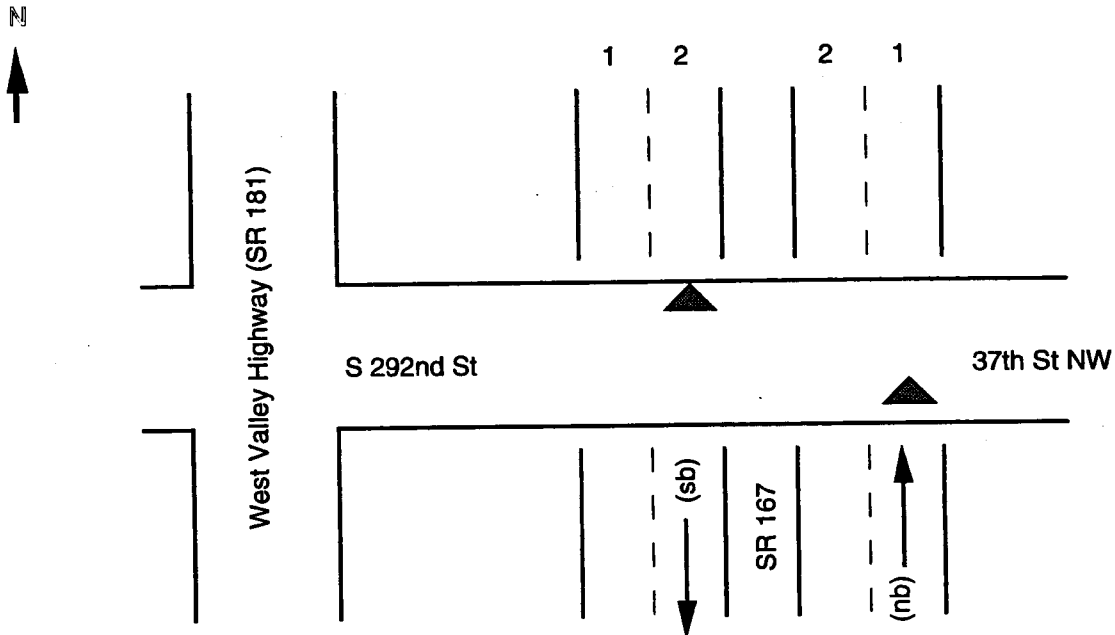

**a.m. northbound**

GP lanes	Qtr.	ACOs				Van	Public Transit	Other Bus	2 Axle	3+ Axle	Motor-cycle	TOTAL ACO OBS.	Counts	
		1	2	3	4+									
2	Q3/93	No observations										--		
	Q4/93	13513	1603	90	21	68	1	11	539	870	23	16739	1.12	28
	Q1/94	7720	923	65	14	15	1	3	323	523	32	9619	1.13	18
	Q2/94	8549	596	59	25	1	1	1	345	514	29	10120	1.09	11
	Q3/94	11014	361	13	13	15	8	4	412	649	41	12530	1.04	15
	Q4/94	8025	547	30	25	3	4	2	235	511	15	9397	1.08	13
	Q1/95	6507	362	20	30	0	2	5	243	404	15	7588	1.07	12
	Q2/95	6721	286	10	46	4	6	0	143	231	34	7481	1.06	9
	No observations conducted Q3/95 - Q1/97											--		
	Q2/97	9701	880	62	16	19	13	10	285	745	25	11756	1.10	20
	Q3/97	12568	1212	114	38	40	11	1	492	1337	64	15877	1.11	24
	No observations conducted Q4/97 - Q1/98											--		
	Q2/98	10065	1040	67	21	12	6	7	559	791	11	12579	1.11	19

169

**SR167 @ 37th NW - Auburn**

**p.m. northbound**

	Qtr.	1	2	3	4+	Van	Public Transit	Other Bus	2 Axle	3+ Axle	Motor- cycle	TOTAL OBS.	ACO	Counts	
GP lanes	Q3/93	No observations											--		
	Q4/93	7797	1953	147	32	24	5	3	356	509	13	10839	1.24	25	
2	Q1/94	3846	929	79	8	9	4	7	117	207	3	5209	1.23	10	
	Q2/94	6616	1182	182	132	5	7	10	349	387	36	8906	1.24	13	
	Q3/94	9927	1342	215	140	5	13	4	396	688	131	12861	1.19	20	
	Q4/94	10886	945	53	63	3	5	6	401	458	19	12839	1.10	19	
	Q1/95	6978	472	32	66	3	7	2	225	213	8	8006	1.10	13	
	Q2/95	10212	434	20	67	1	11	1	365	433	24	11568	1.06	20	
	No observations conducted Q3/95 - Q1/97											--			
	Q2/97	3945	1178	62	15	16	7	1	157	185	20	5586	1.26	9	
	Q3/97	4695	1447	275	75	14	11	10	240	397	38	7202	1.34	12	
	No observations conducted Q4/97 - Q1/98														
	Q2/98	7634	1906	158	56	20	17	20	451	535	46	10843	1.25	19	

160

**a.m. southbound**

	Qtr.	1	2	3	4+	Van	Public Transit	Other Bus	2 Axle	3+ Axle	Motor- cycle	TOTAL OBS.	ACO	Counts	
GP lanes	Q3/93	No observations											--		
	Q4/93	1584	310	8	2	6	2	2	109	180	2	2205	1.17	6	
2	Q1/94	3258	287	48	14	0	2	12	342	394	9	4366	1.12	12	
	Q2/94	4711	393	65	28	4	7	8	269	546	30	6061	1.12	12	
	Q3/94	10101	575	22	37	3	16	6	499	776	52	12087	1.07	20	
	Q4/94	4742	366	19	34	2	13	2	277	452	1	5908	1.10	14	
	Q1/95	4417	310	21	38	0	5	8	313	451	8	5571	1.10	12	
	Q2/95	4528	354	31	63	20	0	1	136	252	7	5392	1.12	15	
	No observations conducted Q3/95 - Q1/97											--			
	Q2/97	6517	421	38	7	13	13	8	280	926	10	8333	1.07	20	
	Q3/97	1398	206	22	12	2	1	0	124	260	1	2026	1.18	4	
	No observations conducted Q4/97 - Q1/98														
	Q2/98	7664	848	76	24	21	10	22	711	1073	19	10468	1.13	22	

137

**SR167 @ 37th NW - Auburn**

**p.m. southbound**

	Qtr.	1	2	3	4+	Van	Public Transit	Other Bus	2 Axle	3+ Axle	Motor- cycle	TOTAL OBS.	ACO	Counts
GP	Q3/93	4188	585	92	12	25	6	2	134	175	31	5250	1.17	6
lanes	Q4/93	9417	2097	218	55	44	9	3	327	433	25	12628	1.23	17
2	Q1/94	2754	364	22	3	8	4	1	62	93	4	3315	1.13	4
	Q2/94	10806	1470	210	57	29	11	1	246	420	49	13299	1.17	15
	Q3/94	13625	1633	164	109	21	17	3	345	577	66	16560	1.15	26
	Q4/94	14592	1379	74	112	30	15	6	260	532	8	17008	1.12	20
	Q1/95	9521	1034	40	136	21	10	3	218	334	23	11340	1.14	13
	Q2/95	8139	580	25	94	8	11	1	159	186	30	9233	1.11	15
	No observations conducted Q3/95 - Q1/97											--		
	Q2/97	7354	1657	133	36	17	12	2	226	313	36	9786	1.22	12
	Q3/97	15978	2921	393	179	134	35	13	352	887	62	20954	1.22	27
	No observations conducted Q4/97 - Q1/98													
	Q2/98	14355	2191	203	52	17	20	9	554	738	56	18195	1.16	24

179

**SITE #98. SR 167 @ S 208th - Kent**

- ACO mainline NB-am
- ACO mainline NB-pm
- ACO mainline SB-am
- ACO mainline SB-pm

**For period ending Q4/94: See following pages for data after HOV lane opened.**

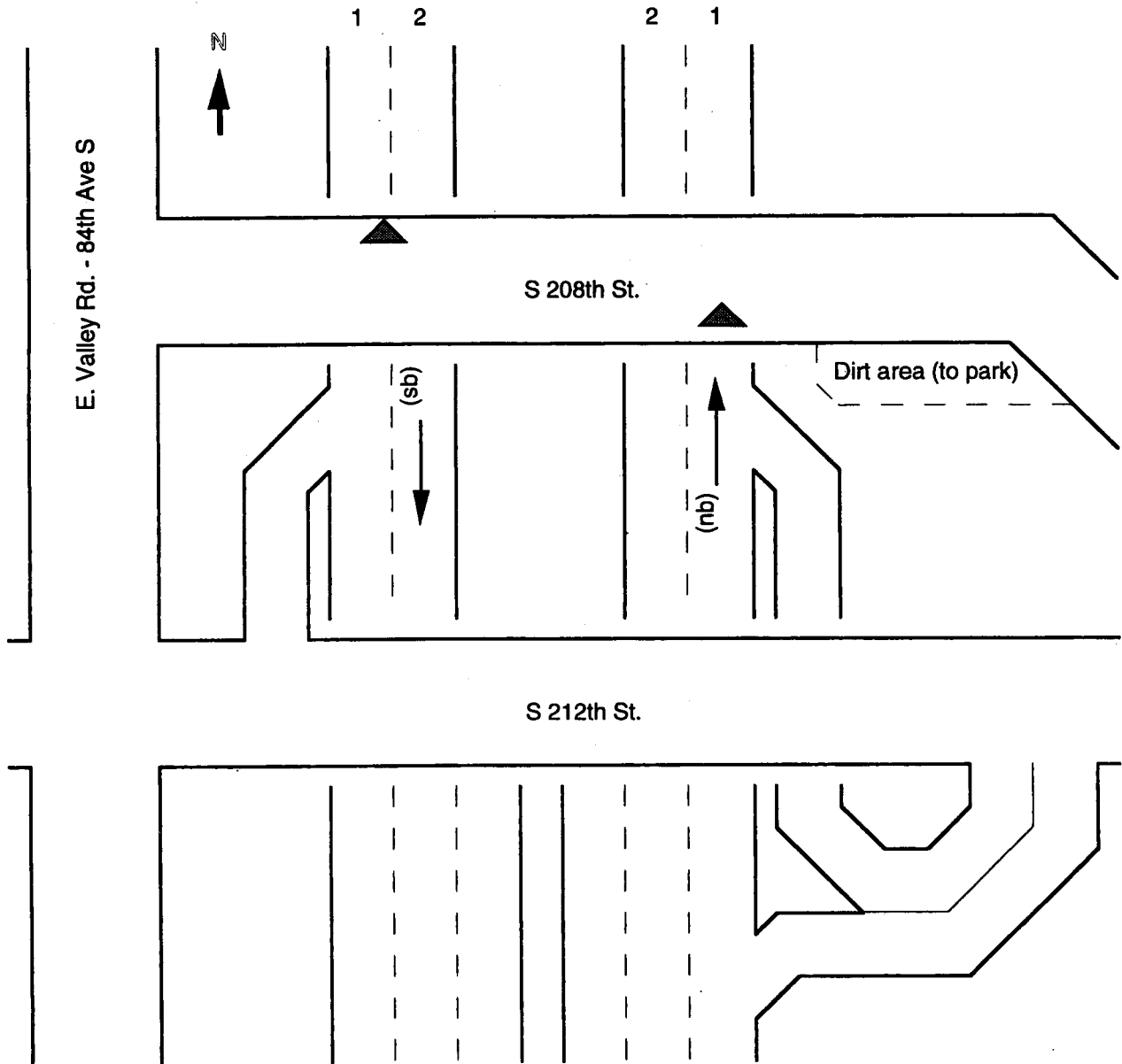

**SR167 @ S 208th - Kent**

**a.m. northbound**

	Qtr.	1	2	3	4+	Van	Public Transit	Other Bus	2 Axle	3+ Axle	Motor- cycle	TOTAL ACO OBS.	Counts	
GP lane 2	Q3/93	9419	959	118	62	18	14	9	448	692	65	11804	1.13	16
	Q4/93	2462	153	20	10	0	1	2	97	187	5	2937	1.09	5
	Q1/94	5660	696	64	14	6	2	3	233	344	6	7028	1.14	9
	Q2/94	4774	537	51	16	11	4	3	233	214	23	5866	1.13	10
	Q3/94	5095	535	61	34	7	6	1	294	393	21	6447	1.13	14
	Q4/94	3857	431	51	7	2	5	3	216	326	4	4902	1.13	14
														68

**p.m. northbound**

	Qtr.	1	2	3	4+	Van	Public Transit	Other Bus	2 Axle	3+ Axle	Motor- cycle	TOTAL ACO OBS.	Counts	
GP lane 2	Q3/93	No observations											--	
	Q4/93	1241	225	19	5	1	0	1	54	18	7	1571	1.19	3
	Q1/94	3717	779	77	29	2	3	3	115	120	3	4848	1.22	9
	Q2/94	2620	525	63	17	6	1	1	81	104	11	3429	1.22	5
	Q3/94	6892	1644	322	206	7	4	6	273	324	31	9709	1.33	18
	Q4/94	3932	521	65	37	3	0	2	113	139	9	4821	1.17	9
														44

**a.m. southbound**

	Qtr.	1	2	3	4+	Van	Public Transit	Other Bus	2 Axle	3+ Axle	Motor- cycle	TOTAL ACO OBS.	Counts	
GP lane 2	Q3/93	704	90	11	1	0	0	1	68	84	5	964	1.14	2
	Q4/93	No observations											--	
	Q1/94	6243	616	36	11	3	2	5	262	370	12	7560	1.10	14
	Q2/94	5104	472	31	16	1	5	6	183	349	18	6185	1.10	15
	Q3/94	5633	616	90	26	4	10	2	232	425	30	7068	1.14	14
	Q4/94	3120	303	38	12	1	1	6	172	262	1	3916	1.12	13
														58

**p.m. southbound**

	Qtr.	1	2	3	4+	Van	Public Transit	Other Bus	2 Axle	3+ Axle	Motor- cycle	TOTAL ACO OBS.	Counts	
GP lane 2	Q3/93	No observations											--	
	Q4/93	No observations											--	
	Q1/94	5112	825	134	35	20	2	0	139	125	4	6396	1.20	7
	Q2/94	5653	906	142	40	29	5	0	157	157	26	7115	1.20	9
	Q3/94	10215	1834	305	132	39	14	4	406	424	52	13425	1.23	18
	Q4/94	4145	676	26	12	21	7	2	143	154	9	5195	1.16	13
														47

**SR167 @ S 208th - Kent**

**Beginning Q1/95: See preceding pages for data prior to HOV lane completion.**

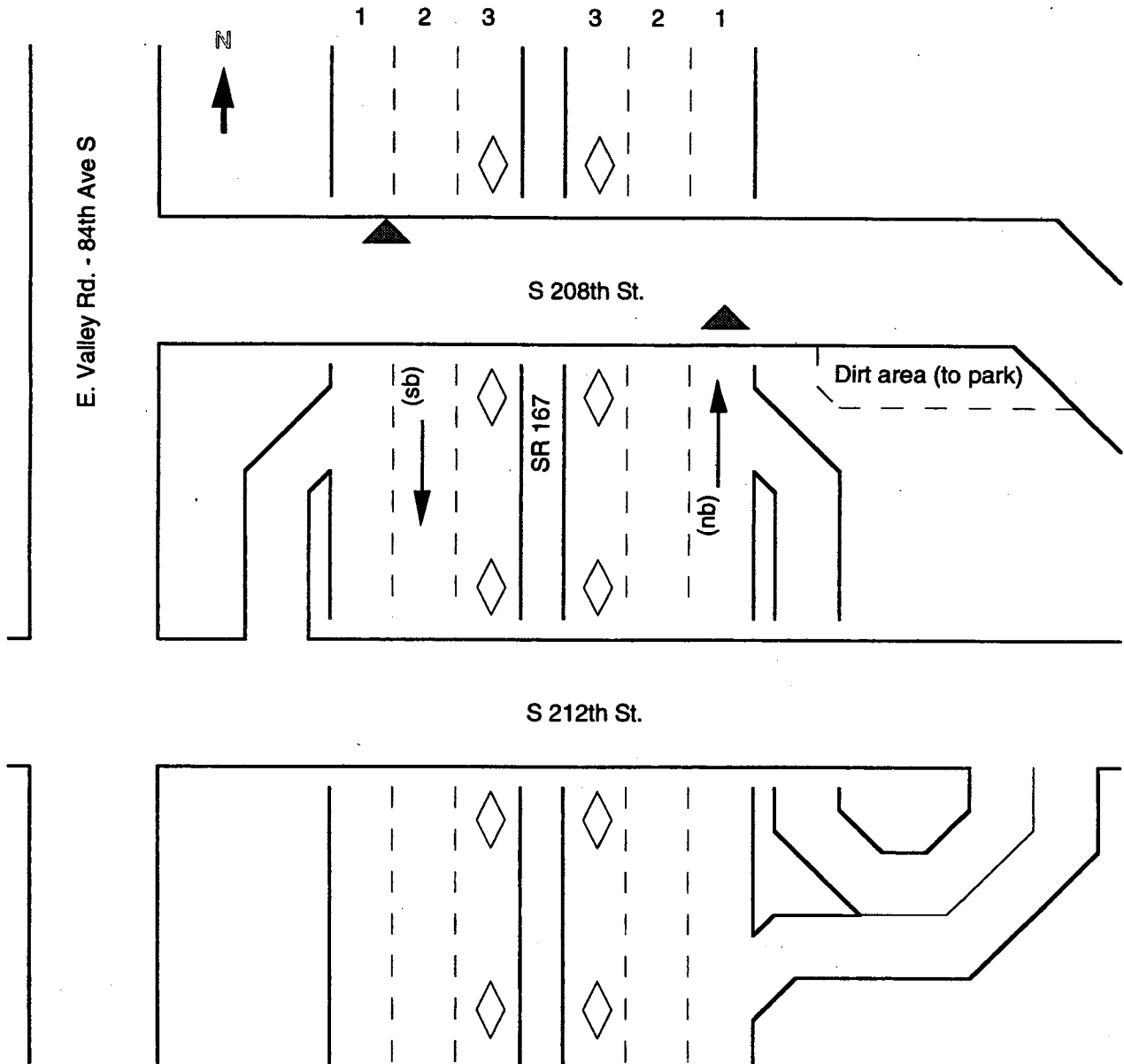

**Note: The HOV lanes opened to traffic on November 19, 1994. Prior to that time the HOV lanes did not exist.**



**SR167 @ S 208th - Kent**

**a.m. northbound**

	Qtr.	1	2	3	4+	Van	Public Transit	Other Bus	2 Axle	3+ Axle	Motor- cycle	TOTAL OBS.	ACO	Counts	
HOV lane 1	Q1/95	23	551	24	7	6	9	0	14	0	6	640	2.03	8	
	Q2/95	49	895	63	17	23	7	3	14	1	23	1095	2.05	13	
	Q3/95	11	446	45	14	8	5	0	12	0	32	573	2.13	10	
	Q3/96	19	499	47	12	15	7	0	6	0	27	632	2.09	10	
	No observations conducted Q4/96 - Q1/97														
	Q2/97	47	991	66	13	26	9	6	4	1	33	1196	2.04	9	
	Q3/97	102	1483	91	25	30	12	1	9	0	56	1809	2.03	12	
	No observations conducted Q4/97 - Q1/98														
	Q2/98	79	1635	192	41	35	13	7	63	3	50	2118	2.10	14	
															76
GP lane 2	Q1/95	1942	179	5	13	0	2	4	137	198	2	2482	1.11	5	
	Q2/95	5804	290	20	12	4	0	0	176	378	11	6695	1.06	11	
	Q3/95	2580	224	25	21	0	0	4	124	220	4	3202	1.12	8	
	Q3/96	3809	244	32	6	5	0	5	174	311	15	4601	1.08	8	
	No observations conducted Q4/96 - Q1/97														
	Q2/97	4609	246	18	2	7	0	0	195	339	7	5423	1.06	8	
	Q3/97	5274	263	34	3	4	3	1	162	364	5	6113	1.06	9	
	No observations conducted Q4/97 - Q1/98														
Q2/98	7022	571	44	6	3	2	16	446	523	9	8642	1.09	12		
														61	

**SR167 @ S 208th - Kent**

**p.m. northbound**

	Qtr.	1	2	3	4+	Van	Public Transit	Other Bus	2 Axle	3+ Axle	Motor- cycle	TOTAL OBS.	ACO	Counts	
HOV lane 1	Q1/95	109	425	24	17	13	0	2	3	2	9	604	1.92	8	
	Q2/95	4	821	87	45	8	2	1	3	1	32	1004	2.19	9	
	Q3/95	25	887	83	21	11	2	5	1	0	49	1084	2.10	9	
	Q3/96	13	512	85	27	16	0	1	3	0	29	686	2.21	12	
	No observations conducted Q4/96 - Q1/97														
	Q2/97	37	590	97	33	5	2	1	3	0	9	777	2.18	6	
	Q3/97	60	654	191	55	14	0	3	3	1	25	1006	2.26	10	
	No observations conducted Q4/97 - Q1/98														
	Q2/98	47	1175	165	57	14	7	4	17	0	29	1515	2.17	16	
															70

GP lane 2	Q1/95	2365	251	15	14	1	0	1	77	86	12	2828	1.13	7	
	Q2/95	3245	641	42	43	1	0	1	89	121	13	4196	1.22	8	
	Q3/95	3620	493	84	22	4	2	3	86	98	9	4421	1.17	8	
	Q3/96	2634	406	39	23	7	1	4	87	138	17	3356	1.18	8	
	No observations conducted Q4/96 - Q1/97														
	Q2/97	2621	566	71	32	8	4	0	74	71	1	3448	1.25	6	
	Q3/97	2967	628	106	72	31	2	4	93	129	15	4047	1.28	9	
	No observations conducted Q4/97 - Q1/98														
	Q2/98	4848	905	105	45	14	2	3	172	240	13	6347	1.21	12	
															58

**a.m. southbound**

	Qtr.	1	2	3	4+	Van	Public Transit	Other Bus	2 Axle	3+ Axle	Motor- cycle	TOTAL OBS.	ACO	Counts	
HOV lane 1	Q1/95	35	499	23	17	17	26	4	6	0	10	637	2.04	7	
	Q2/95	34	334	24	4	8	10	1	1	1	8	425	2.00	11	
	Q3/95	0	62	4	3	1	2	1	0	0	5	78	2.15	5	
	Q3/96	39	342	39	7	1	8	5	4	0	10	455	2.04	9	
	No observations conducted Q4/96 - Q1/97														
	Q2/97	47	234	24	5	11	9	3	2	0	19	354	1.96	9	
	Q3/97	88	304	59	29	28	5	8	12	1	14	548	2.07	10	
	No observations conducted Q4/97 - Q1/98														
	Q2/98	89	361	30	5	7	7	3	11	2	9	524	1.90*	9	
															60

**SR167 @ S 208th - Kent**

**a.m. southbound**

GP lane	Q1/95	1463	158	13	5	1	3	5	111	193	0	1952	1.12	7
	Q2/95	4206	224	21	6	0	8	0	146	287	7	4905	1.06	9
2	Q3/95	1052	48	6	1	0	1	1	40	88	5	1242	1.06	5
	Q3/96	2007	124	23	6	0	3	1	74	211	3	2452	1.09	6
No observations conducted Q4/96 - Q1/97														
	Q2/97	3061	164	16	5	5	5	1	108	257	4	3626	1.07	8
	Q3/97	3125	191	20	7	6	5	2	159	358	6	3879	1.08	8
No observations conducted Q4/97 - Q1/98														
	Q2/98	3625	225	8	17	9	1	1	243	327	9	4465	1.08	8
														51

**p.m. southbound**

	Qtr.	1	2	3	4+	Van	Public Transit	Other Bus	2 Axle	3+ Axle	Motor-cycle	TOTAL OBS.	ACO	Counts
HOV lane	Q1/95	342	809	79	18	40	1	0	16	4	19	1328	1.82*	7
	Q2/95	214	1100	104	13	18	3	0	21	19	18	1510	1.94*	7
1	Q3/95	186	1558	158	60	59	2	1	11	3	31	2069	2.05	9
	Q3/96	235	1658	194	54	46	4	1	13	3	44	2252	2.04	14
No observations conducted Q4/96 - Q1/97														
	Q2/97	193	1896	185	36	16	8	1	25	2	36	2398	2.03	8
	Q3/97	371	1561	309	99	62	5	5	26	8	46	2492	2.07	10
No observations conducted Q4/97 - Q1/98														
	Q2/98	770	2874	442	122	47	14	15	124	18	41	4467	1.99*	16
														71
GP lane	Q1/95	4102	374	39	14	7	2	1	120	139	2	4800	1.11	9
	Q2/95	3014	518	36	11	5	1	0	84	103	5	3777	1.17	6
2	Q3/95	5161	494	87	26	11	3	2	144	206	14	6148	1.13	8
	Q3/96	5398	546	92	27	8	6	1	143	271	28	6520	1.13	11
No observations conducted Q4/96 - Q1/97														
	Q2/97	5149	474	33	8	10	2	1	143	160	9	5989	1.01	8
	Q3/97	8440	1019	87	27	44	7	4	235	335	37	10235	1.13	14
No observations conducted Q4/97 - Q1/98														
	Q2/98	6742	754	73	21	28	5	9	280	267	22	8201	1.13	12
														68

\* ACO low due to high percentage of violators in most counts.

**APPENDIX C**

**Observer Comments Made During Vehicle Occupancy Sessions**

Below is a sample of comments made by observers while collecting occupancy data throughout this period. Generally, these comments can be categorized into three types: comments regarding data collection, comments about traffic conditions, and comments about weather conditions. Ellipses represent time gaps between comments made by the observer. Because the length of comments is limited by the program used, words are sometimes cut off.

### **DATA COLLECTION**

1. actually counting i-5nb off/r at madison st. mainline's moving well.
2. hard to see people in the back seat due to the angle
3. cars in this lane enter a patch of shade just before i can see them clearly, and don't emerge until just before they go under the overpass. on such a bright, sunny day, it makes it hard to see into back seats, esp in dark colored cars.
4. rolling slowdown, site is ok, sidewalk on s side is too narrow, so I'm watching them going away from me
6. just lost a file I started at half capacity battery I couldn't believe it
7. just lose a count, battery dead backup battery is also not full?! I will count as much as it can do
8. hve to go to meet other observers
9. no light for the inside lanes.....end counting
10. trying to get bus numbers
11. taking a break

### **TRAFFIC CONDITIONS**

1. traffic in fast lane came to an abrupt stop one car skidded- almost a crash.....traffic is flowing smoothly again, but traffic speed is less than 55.....another quick stop in the fast lane along with some more burnt rubber.
2. CARS ENTERING FROM TOWN CROSS OVER LANES HER
3. MAINLINE OFF-RAMP AT STEWART ST. ST.....EXPRESS LANE OFF-RAMP CLD BE COUNTED HERE BY A SECOND

PERSON.....THERE ARE POSSIBLY, AGAIN AS MANY CARS  
EXITTING FROM THE EXPRESS LANES AS THIS

4. TRAFFIC HAS MOVED WELL ALL MORNING, ONLY ONE SLOW-DOWN
5. JUST AS THIS LANE COUNT CLOSES, THE SPEED OF FLOW DROPS TO A CRAWL
6. THE BUSES HAD NO PASSENGERS
7. congestion because of traffic lights occurred during the last 20 minute
8. mainline is moving very slowly. The motorcycle that exited here had 2 occupants .
9. foggy-49 degrees, wet road.....traffic is heavy but is moving.....traffic slows down.....stop and go traffic.....my battery is running out.....accident below the overpass.....I think the driver saw me and did not look at the traffic

#### WEATHER CONDITIONS

1. mountains are absolutely beautiful. Clear as a bell.
2. FREEZING/HARD RAIN
3. hot, hot, hot, hot,
4. sunny, hot, windy
5. clear, beautiful
6. rain rain rain
7. sunny and clear
8. cold, overcast, dark, finger-numbin' fun
9. cold drizzle--and i forgot my damn glove
10. Some sunshine bvt not enuf

**APPENDIX D**

**ACO DATA ANALYSIS**

**Table D1: Adjustment Factors**

<b>Days</b>	<b>Lane</b>	<b>Ramps</b>
Mon.	.000	.000
Tue.	-.001	.004
Wed.	-.001	.002
Thur.	-.002	.009
Fri.	.021	.025
<b>Quarter</b>		
Q3	.000	.000
Q4	-.021	-.044
Q1	-.020	-.046
Q2	-.019	-.021
<b>Lanes</b>		
HOV	0	na
In	-.984	na
Mid	-1.046	na
Out	-.982	na

**USING TABLE D1 ADJUSTMENT FACTORS**

To use the adjustment factors presented in table D1, merely add (subtract) the appropriate number to the ACO figures presented in Appendix B, based on the applicable parameters. Continuing the example of the northbound general purpose lanes of I-5 at NE 145th Street during the evening peak in Chapter Three, one would perform the following steps to correct the observed ACO for sample bias.

1. Lookup the ACO value for each quarter of I-5 North, NE 145th Street (Site 14), p.m., northbound general purpose lanes. This yields the following values:  
Q4/92 = 1.12  
Q1/93 = 1.13
2. Adjust the ACO for each quarter according to Table D1 as follows:  
Q4/92 = 1.12 - 0.021 = 1.099  
Q1/93 = 1.13 - 0.020 = 1.110

One can now conclude that ACO slightly increased during Q4/92 through Q1/93.



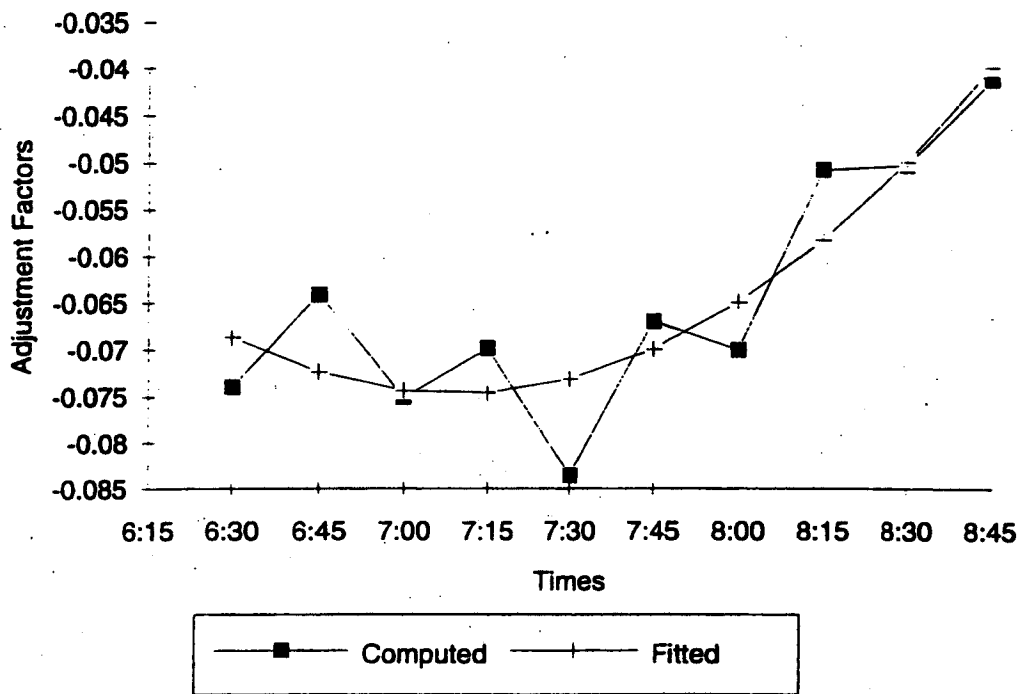

Figure D1. AVO Adjustment Factors – AM Lanes

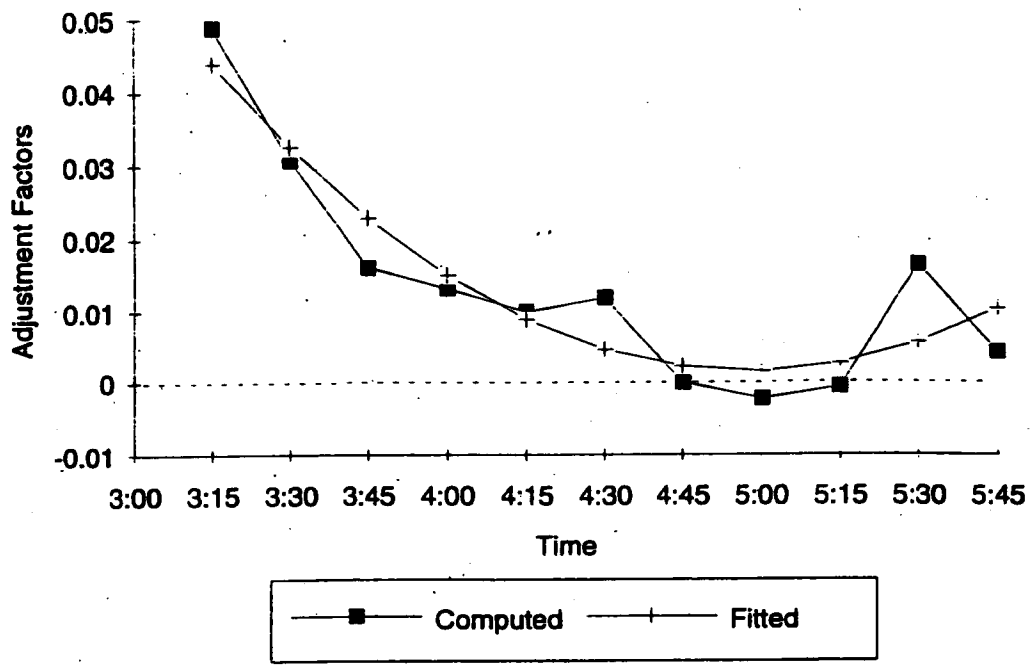

Figure D2. AV0 Adjustment Factors – PM Lanes

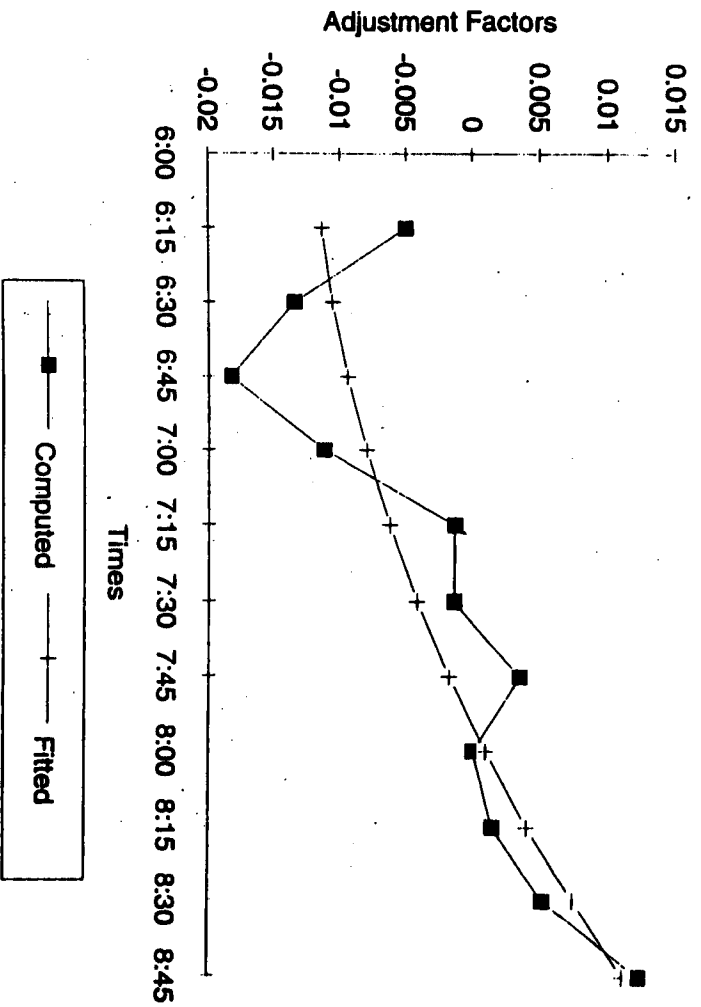

Figure D3. AVO Adjustment Factors - AM Ramps

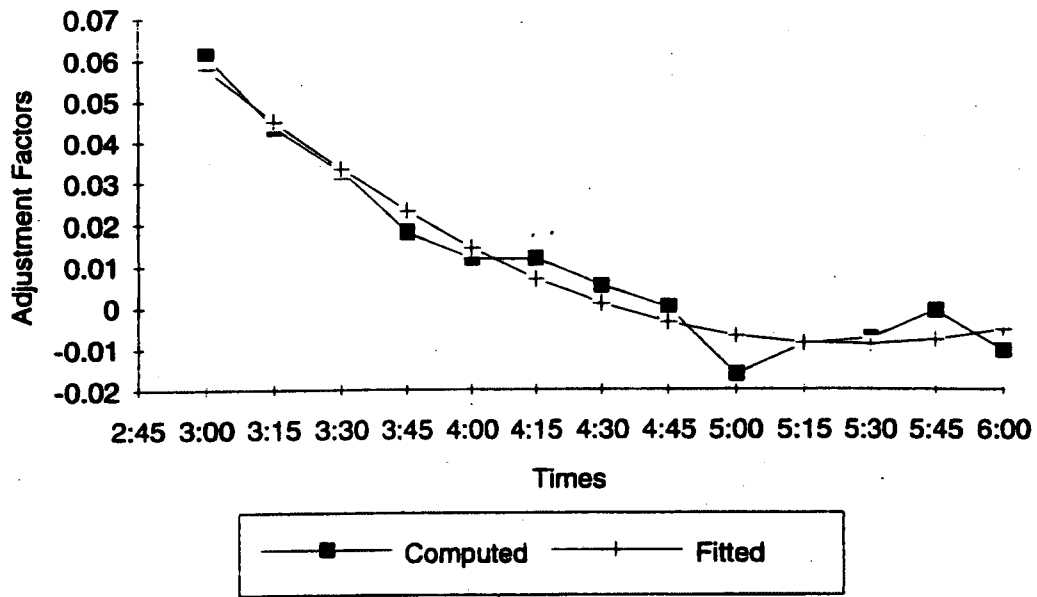

Figure D4. AVO Adjustment Factors – PM Ramps

**APPENDIX E**

**Baseline Travel Time Data  
(License plate matching method)**

**Table E1: Baseline Travel Time Observation Sites, July 1992 - October 1993**

I-5 North (corridor 1)	I-5 Downtown (corridor 2)	I-5 South (corridor 3)
11 = SW 236th St.	21a = Lakeview Blvd.	31
12	21b = Roanoke St.	32 = S 188th/ Orilla Rd
13 = N 175th St.	22 = S Holgate St.	33 = S 200th St.
14 = N 145th St.	23 = Michigan St.	34 = S 216th St.
15	24 = Corson Ave. S	35 = SR 516 --Kent/DesMoine Rd
16 = NE Northgate Wy	25 = Albro Pl.	36 = SR 516 --Kent Ramp
	27 = Olive St.	37 = SR 516 --DesMoines Ramp
	28 = Howell & Yale	38
	29 = Madison St.	39 = S 272nd St.
	20 = Stewart St.	
SR 520 (corridor 4)	I-90 (corridor 5)	I-405 South (corridor 6)
41 = Hunt's Point	51	61 = Tukwila Pkwy --Southcenter
42 = Yarrow Point	52 = Reversible Lanes (I-90 Bridge)	62 = SR 167 -Renton
43 = SR 908 -Bellevue/Kirkland	53 = 60th Ave. SE/W Mercer Wy	63
44 = 124th Ave. NE	54 = Island Crest Wy	64 = S Park Dr
45 = 148th Ave. NE	55 = E Mercer Wy	65 = 112th Ave. SE /Lake Washington
46 = 148th -Redmond Ramp	56 = Bellevue Wy	
47 = 148th -Bellevue Ramp	57 = Newport Wy --Issaquah	
	58 = Front St. --Issaquah	
	59 = 142nd Ave.	
	50 = SR 900	
I-405 Central (corridor 7)	I-405 North (corridor 8)	Outlying Locations (corridor 9)
71 = SE 8th St. -Bellevue	81 = SR 908 --Kirkland/Redmond	91 = I-5 N @ 112th SE --Everett
72 = NE 8th St.		92 = I-5 S @ Fife
73a = NE 12th St.		93 = I-5 S @ Tacoma Mall
73b = NE 4th St.		94 = SR 16 @ Tacoma Narrows Bridge
		95 = SR 512 @ Ainsworth/Steele
		96 = SR 410 @ Valley Ave. --Sumner
		97 = SR 167 @ 37th NW --Auburn
		98 = SR 167 @ S 208th --Kent

\*Site numbers with no designation indicate discontinued sites.

**Table E2. Travel Time Study Section Length**

<b>Study Section</b>	<b>Length (kilometers)</b>
<b>North I-5</b>	
236th St. SW to NE 117th St.	8.2
NE 117th St. to NE 185th St.	5.8
<b>Downtown I-5</b>	
Lakeview Blvd. E to S Holgate St.	5.0
Lakeview Blvd. E to Albro Pl.	9.4
Lakeview Blvd. E to S 144th St.	18.9
S Holgate St. to Albro Pl.	4.4
S Holgate St. to S 144th St.	14.0
Albro Pl. to S 144th St.	9.5
<b>South I-5</b>	
S 178th St. to S 216th St.	4.5
S 260th St. to S 216th St.	4.3
<b>SR 520</b>	
SR 908 to Hunt's Pt.	2.7
148th Ave. NE to Hunt's Pt.	7.9
Hunt's Pt. to SR 908	2.7
148th Ave. NE to SR 908	5.2
<b>I-90</b>	
23rd Ave. S to E Mercer Way	7.7
E Mercer Way to 35th Ave. S	6.6
<b>I-405</b>	
Tukwila Pkwy. to Benson Rd. S	3.4
Tukwila Pkwy. to 112th Ave. SE	14.0
Tukwila Pkwy. to NE 12th St.	21.5
Tukwila Pkwy. to SR 908	27.5
Benson Rd. S to 112th Ave. SE	10.3
Benson Rd. S to NE 12th St.	18.1
Benson Rd. S to SR 908	24.1
112th Ave. SE to NE 12th St.	7.8
112th Ave. SE to SR 908	13.8
NE 12th St. to SR 908	6.0

I-5 North



○ Travel Time Site

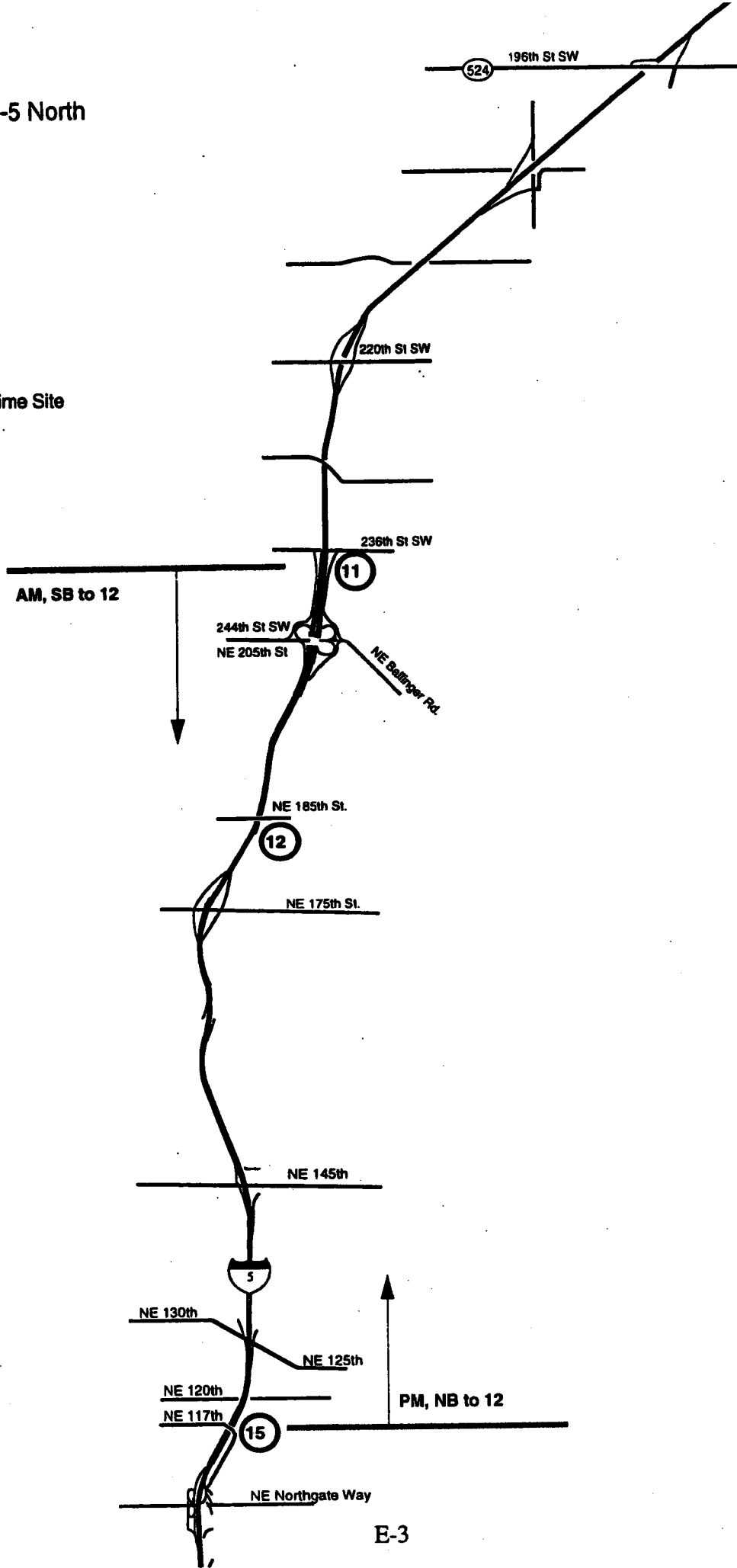



Travel times SB-am

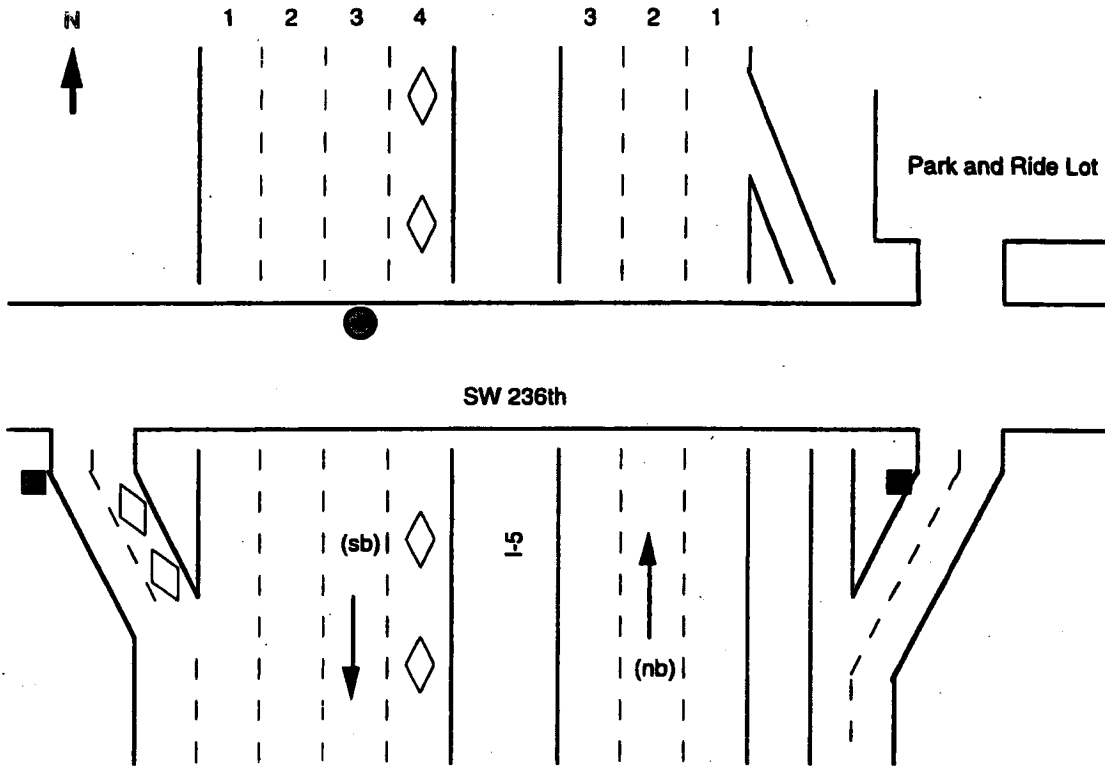

Travel times NB-pm

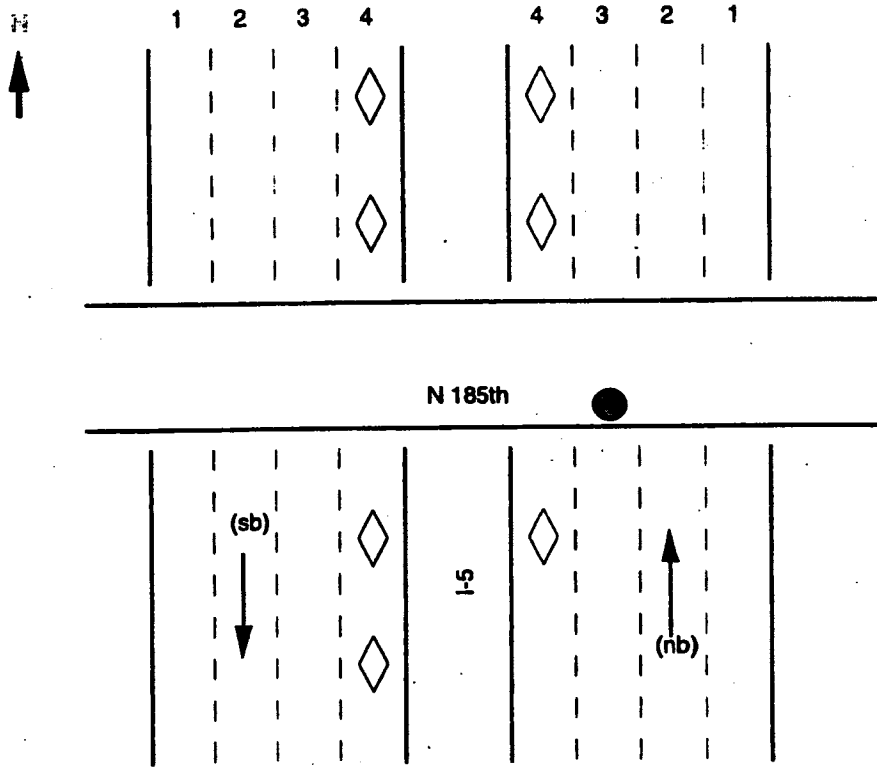

Travel times SB-am  
Travel times NB-pm

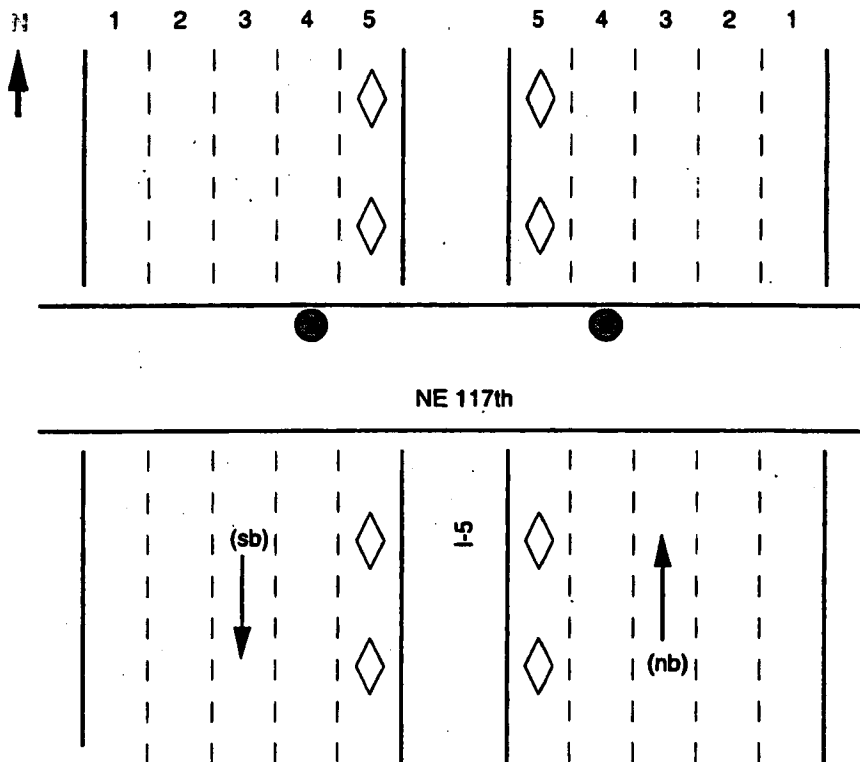

Note: There is a sidewalk only on the north side of this overcrossing. You may count southbound traffic as it comes toward you, but you must count northbound traffic as it comes under the overcrossing and goes away from you.

Table 1 North I-5 SW 236th St. to 117th St. NE, southbound a.m.

GP Lanes	Qtr.	North I-5 SW 236th St. to 117th St. NE, southbound a.m.													
		6:00	6:15	6:30	6:45	7:00	7:15	7:30	7:45	8:00	8:15	8:30	8:45	9:00	9:15
GP Lanes	Q3/92	-	-	-	59.5	59	58	56.8	55	52.6	53.6	57.6	58.6	59	59.4
	Q4/92	-	-	-	-	-	-	-	-	-	-	32.6	32	-	-
	Q1/93	-	-	-	-	-	-	-	-	-	-	-	-	-	-
	Q2/93	-	-	-	-	57.6	-	-	-	53	-	-	-	-	-
HOV Lanes	Q3/92	-	-	-	-	55.7	57.1	53.6	55.8	55.5	53.7	56.3	57.4	58.8	-
	Q4/92	-	-	-	-	-	-	-	-	-	-	50	-	-	-
	Q1/93	-	-	-	-	-	-	-	-	-	-	-	-	-	-
	Q2/93	-	-	-	-	-	-	-	-	54.7	-	-	-	-	-

Table 2 North I-5 117th St. NE to N 185th St., northbound p.m.

GP Lanes	Qtr.	North I-5 117th St. NE to N 185th St., northbound p.m.													
		3:00	3:15	3:30	3:45	4:00	4:15	4:30	4:45	5:00	5:15	5:30	5:45	6:00	6:15
GP Lanes	Q3/92	-	-	52.6	57.4	53.6	42.5	36.8	29.7	31.2	31.7	27.1	28.7	35.4	46.7
	Q4/92	-	-	5.3	9.8	31.3	34.9	22.9	37.3	-	-	-	-	-	-
	Q1/93	-	1.2	-	-	-	-	-	-	-	-	-	-	-	-
	Q2/93	-	-	-	-	2.1	60.2	61.3	43.3	52.2	43.2	59.9	57	59.8	58.4
HOV Lanes	Q3/92	-	-	51.6	61.9	65.1	45	37.3	33.8	42.9	37.6	46.5	39.9	44.6	54.3
	Q4/92	-	-	-	-	37.7	28.1	-	43.4	-	-	-	-	-	-
	Q1/93	-	-	-	-	-	-	-	-	-	-	-	-	-	-
	Q2/93	-	-	-	-	-	59.2	60.4	59.3	58.6	55.3	58	57.3	57.5	56.5

**Figure E5. Travel Time Sites  
I-5 Downtown (Corridor #2N)**

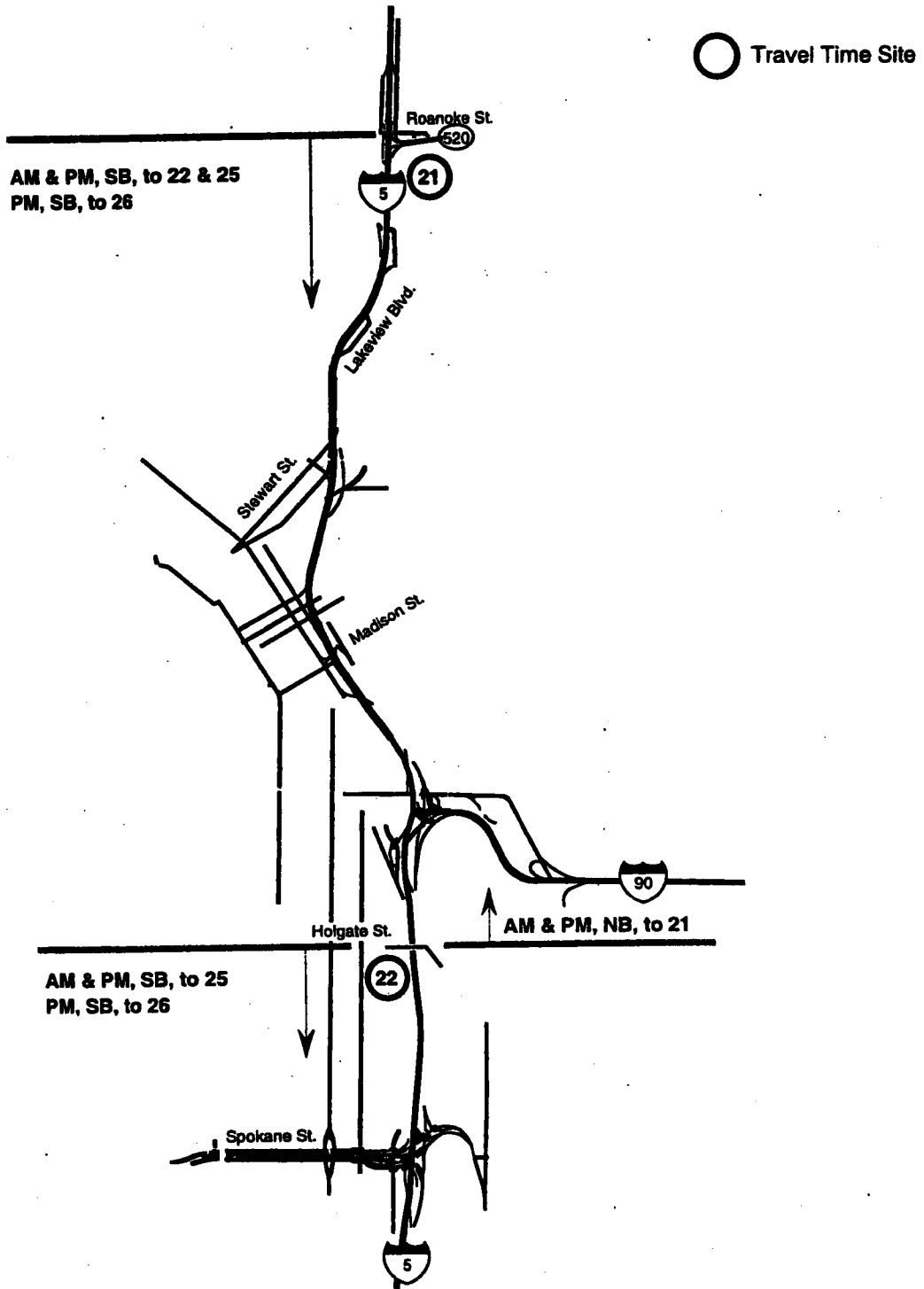

**Figure E5. Travel Time Sites (cont.)  
I-5 Downtown (Corridor #2S)**

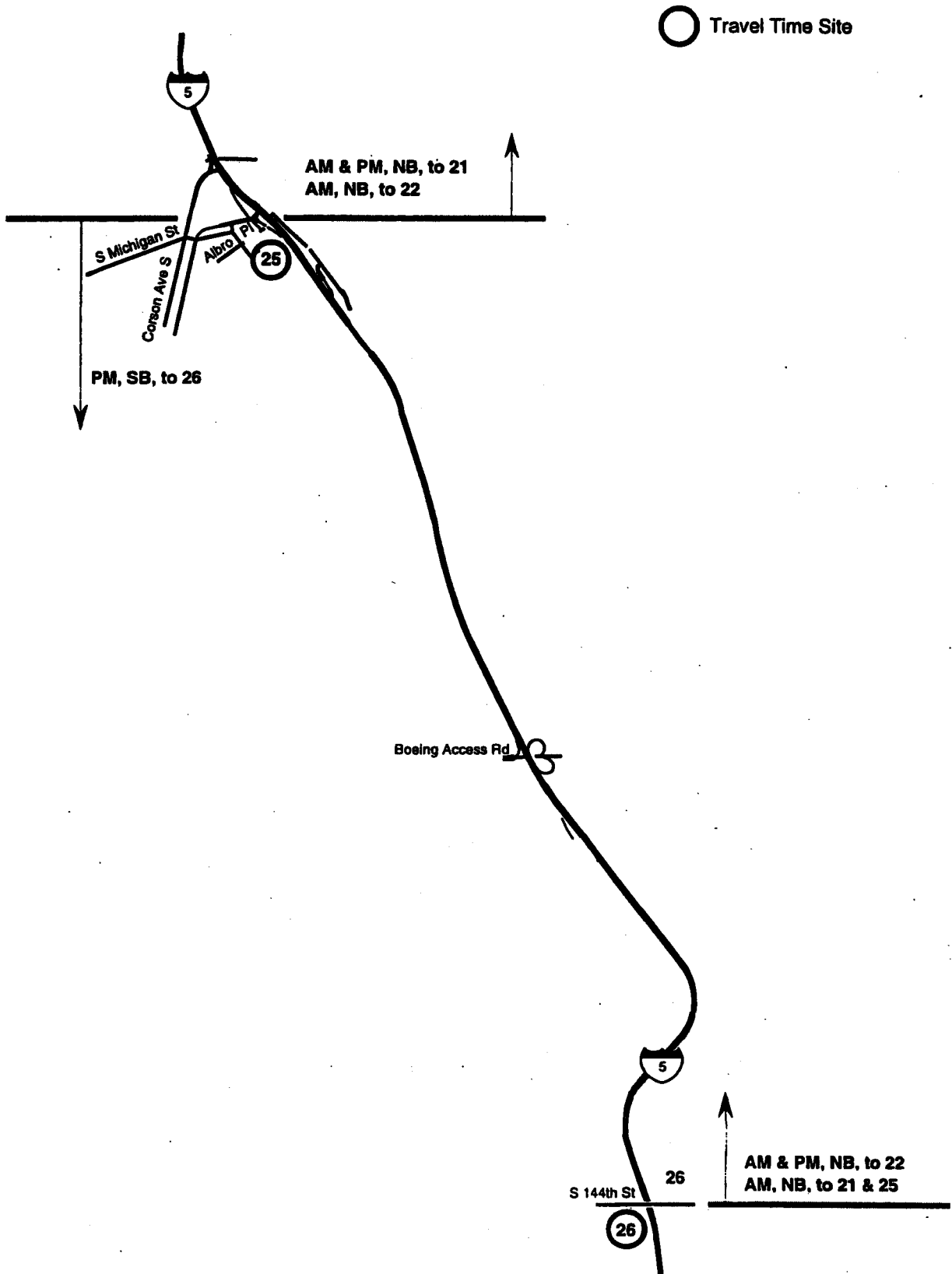

Travel times SB&NB-am&pm

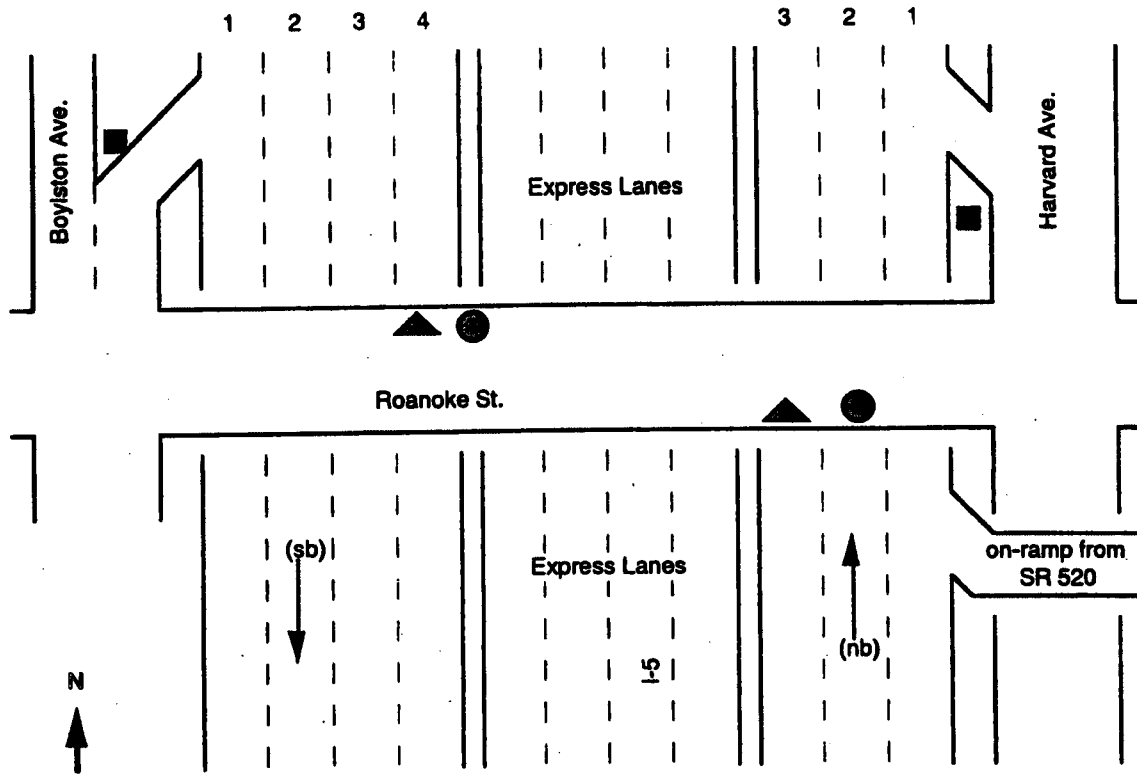

Travel times SB & NB-am & pm

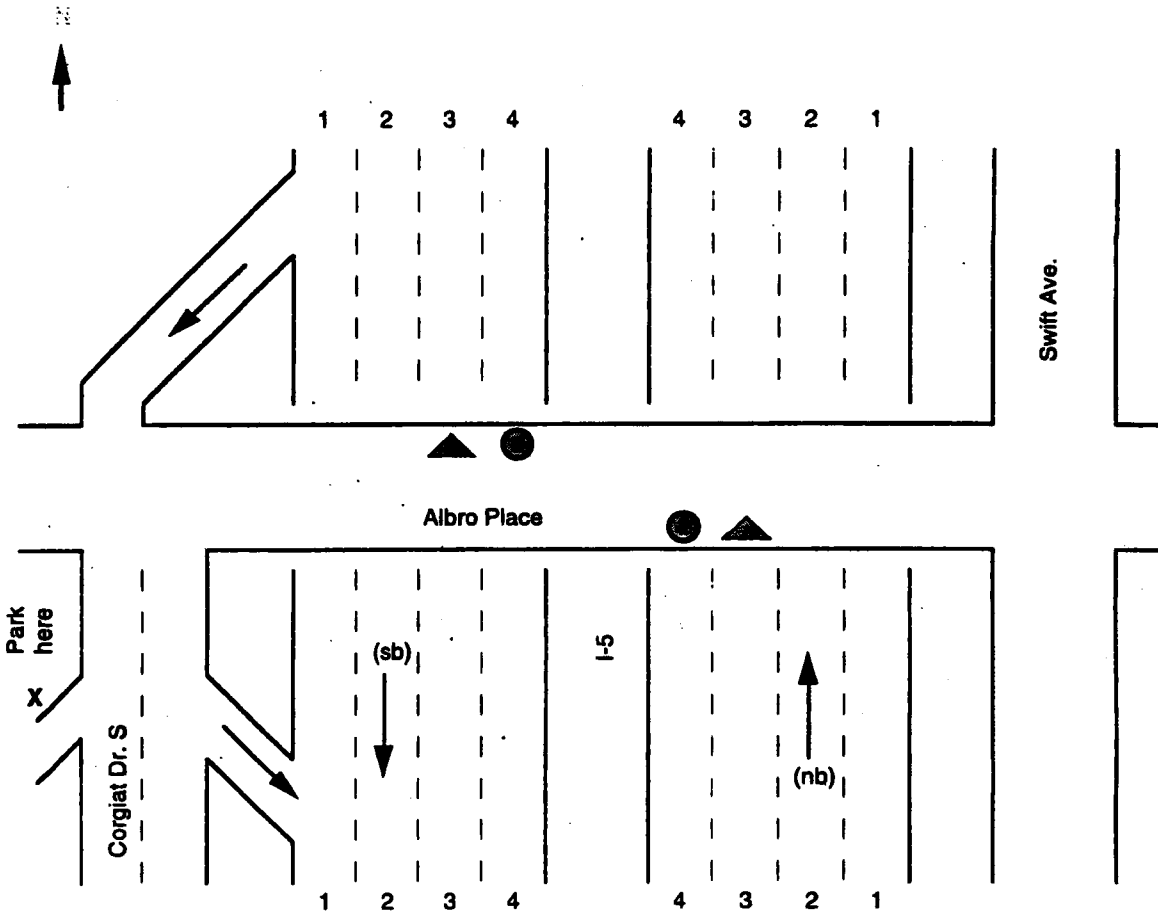

Travel times NB-am & SB-pm

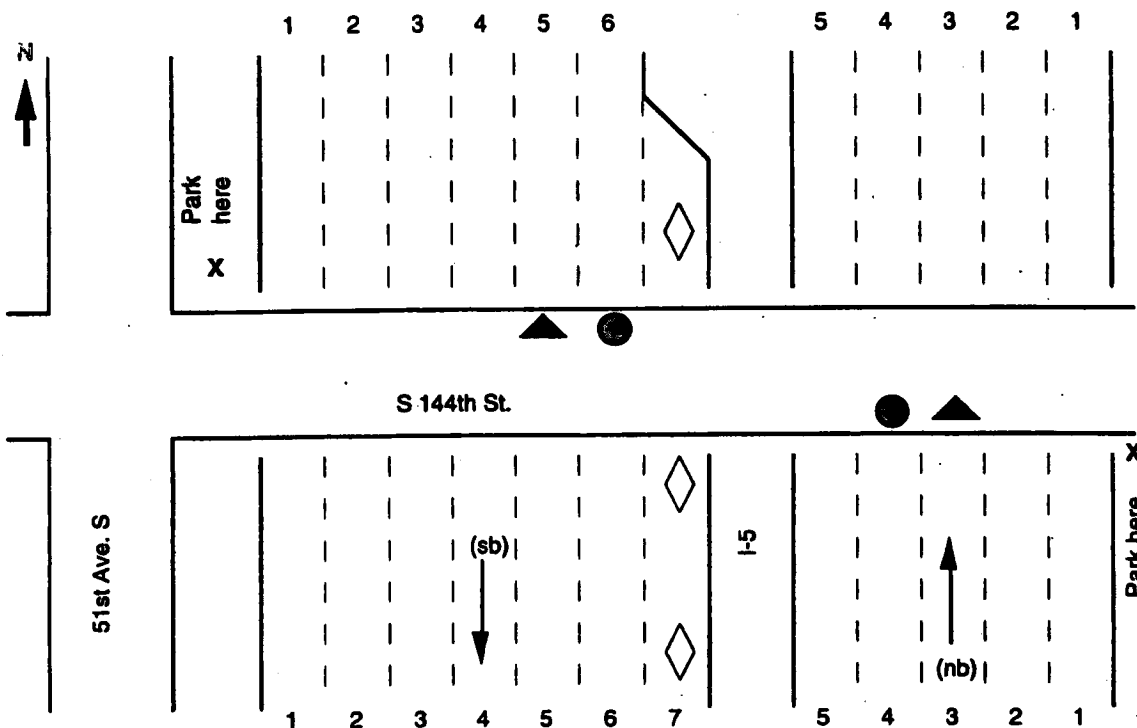

**Table 3 I-5 Downtown Lakeview E to Holgate St. , southbound a.m.**

	Qtr.	6:00	6:15	6:30	6:45	7:00	7:15	7:30	7:45	8:00	8:15	8:30	8:45	9:00	9:15
GP Lanes	Q3/92	-	-	-	-	60.8	57.4	50.5	44.3	48.3	52.1	53.8	49.5	52.3	57
	Q4/92	-	-	-	-	-	-	-	53.3	57.1	-	58	-	-	-
	Q1/93	-	-	-	-	-	-	-	-	-	-	-	-	-	-
	Q2/93	-	-	-	-	-	-	-	58.9	56	59.6	-	-	-	-

**Table 4 I-5 Downtown Lakeview E to Holgate St. , southbound p.m.**

	Qtr.	3:00	3:15	3:30	3:45	4:00	4:15	4:30	4:45	5:00	5:15	5:30	5:45	6:00	6:15
GP Lanes	Q3/92	-	-	26.1	27.5	24.7	25.4	24.9	25.3	25.7	26	27.9	22.5	18.4	-
	Q4/92	-	-	-	-	-	-	-	-	-	-	-	-	-	-
	Q1/93	-	-	-	-	35.5	33.1	42.8	28.2	40.1	39.1	22.1	12.4	2	1.8
	Q2/93	-	-	-	-	31.4	25.2	27.4	24.2	29.3	29.8	38.6	43.1	46.2	-

**Table 5 I-5 Downtown Lakeview E to Albro Pl. , southbound a.m.**

	Qtr.	6:00	6:15	6:30	6:45	7:00	7:15	7:30	7:45	8:00	8:15	8:30	8:45	9:00	9:15
GP Lanes	Q3/92	-	-	-	-	-	47.5	44.5	34.5	31	46.7	54.6	53.7	55.7	-
	Q4/92	-	-	-	-	-	-	-	55.5	52.3	57.2	56.7	-	-	-
	Q1/93	-	-	-	-	-	-	-	-	-	-	-	-	-	-
	Q2/93	-	-	-	-	-	-	-	-	-	-	-	-	-	-

**Table 6 I-5 Downtown Lakeview E to Albro Pl. , southbound p.m.**

	Qtr.	3:00	3:15	3:30	3:45	4:00	4:15	4:30	4:45	5:00	5:15	5:30	5:45	6:00	6:15
GP Lanes	Q3/92	-	-	-	31.3	31.9	32.4	32	33.9	34.7	34.4	33.9	31	26.9	31.5
	Q4/92	-	-	-	-	-	-	-	-	-	-	-	-	-	-
	Q1/93	-	-	-	7.8	-	14.2	-	-	-	-	-	-	-	-
	Q2/93	-	-	-	-	-	-	-	-	-	-	-	-	-	-



Table	7	I-5 Downtown		Lakeview E to S 144th St. , southbound p.m.											
	Qtr.	3:00	3:15	3:30	3:45	4:00	4:15	4:30	4:45	5:00	5:15	5:30	5:45	6:00	6:15
GP Lanes	Q3/92	-	-	-	-	-	-	-	-	-	-	-	-	-	-
	Q4/92	-	-	-	-	-	-	-	-	-	-	-	-	-	-
	Q1/93	-	-	-	-	53.4	-	-	-	-	-	-	-	-	-
	Q2/93	-	-	-	-	-	-	-	-	-	-	-	-	-	-

Table	8	I-5 Downtown		Holgate St. to Lakeview E , northbound a.m.											
	Qtr.	6:00	6:15	6:30	6:45	7:00	7:15	7:30	7:45	8:00	8:15	8:30	8:45	9:00	9:15
GP Lanes	Q3/92	-	-	-	60.3	56.1	41.5	54.4	55.2	55.3	49.8	52.1	50	55.1	50.7
	Q4/92	-	-	-	-	-	-	-	-	-	-	-	31.9	-	-
	Q1/93	-	-	-	-	-	-	-	-	-	-	-	-	-	-
	Q2/93	-	-	-	-	56.6	53.4	51	53.7	47.3	49.3	-	-	-	-

Table	9	I-5 Downtown		Holgate St. to Lakeview E , northbound p.m.											
	Qtr.	3:00	3:15	3:30	3:45	4:00	4:15	4:30	4:45	5:00	5:15	5:30	5:45	6:00	6:15
GP Lanes	Q3/92	-	-	-	27.9	-	-	-	-	-	32.9	-	32	-	-
	Q4/92	-	-	-	-	-	36.4	-	-	-	-	-	-	-	-
	Q1/93	-	-	-	-	-	44.9	6.1	5.5	3	-	2.2	1.8	1.6	-
	Q2/93	-	-	1.9	10.7	35.8	28.6	28.2	32.1	31.3	33.9	26.9	32.3	27.9	-

Table	10	I-5 Downtown		Holgate St. to Albro Pl. , southbound a.m.											
	Qtr.	6:00	6:15	6:30	6:45	7:00	7:15	7:30	7:45	8:00	8:15	8:30	8:45	9:00	9:15
GP Lanes	Q3/92	-	-	-	-	-	-	50.4	60.4	67.3	54.8	67.1	67.2	69	-
	Q4/92	-	-	-	-	-	-	54.1	53.3	54.9	56.4	56.4	56.7	-	-
	Q1/93	-	-	-	-	-	-	-	-	-	-	-	-	-	-
	Q2/93	-	-	-	-	-	-	-	-	-	-	-	-	-	-

Table	11	I-5 Downtown		Holgate St. to Albro Pl. , southbound p.m.											
	Qtr.	3:00	3:15	3:30	3:45	4:00	4:15	4:30	4:45	5:00	5:15	5:30	5:45	6:00	6:15
GP Lanes	Q3/92	-	-	-	58.1	58	56.6	57	59.3	60.8	60.2	57.2	61.1	54.8	59.3
	Q4/92	-	-	-	40	49.7	50.6	56.8	54.5	52.7	-	-	-	-	-
	Q1/93	-	-	-	58.4	61.7	58.3	61.8	51.6	62.4	63.4	64.4	64.8	63.3	64.5
	Q2/93	-	-	-	-	58.4	53.9	53.9	52.4	63.3	-	63.4	63.2	63.5	-

Table	12	I-5 Downtown		Holgate St. to S 144th St. , southbound p.m.											
	Qtr.	3:00	3:15	3:30	3:45	4:00	4:15	4:30	4:45	5:00	5:15	5:30	5:45	6:00	6:15
GP Lanes	Q3/92	-	-	47	-	19.3	15.2	20.6	24	22.6	32.5	34.8	53.6	52.9	-
	Q4/92	-	-	-	-	15.2	20.5	17.2	11.4	11.9	16.1	17.2	31.5	23.4	-
	Q1/93	-	-	-	-	-	-	-	-	-	-	-	-	-	-
	Q2/93	-	-	-	-	-	-	-	-	-	-	-	-	-	-

Table	13	I-5 Downtown		Albro Pl. to Lakeview E , northbound a.m.											
	Qtr.	6:00	6:15	6:30	6:45	7:00	7:15	7:30	7:45	8:00	8:15	8:30	8:45	9:00	9:15
GP Lanes	Q3/92	-	-	-	-	24.2	55.9	56	48.8	29.2	39.8	53.6	44.3	46.6	50.7
	Q4/92	-	-	-	-	-	-	-	-	-	-	-	-	-	-
	Q1/93	-	-	-	-	-	-	-	-	-	-	-	-	-	-
	Q2/93	-	-	-	-	-	-	-	-	-	-	-	-	-	-

Table	14	I-5 Downtown		Albro Pl. to Lakeview E , northbound p.m.											
	Qtr.	3:00	3:15	3:30	3:45	4:00	4:15	4:30	4:45	5:00	5:15	5:30	5:45	6:00	6:15
GP Lanes	Q3/92	-	-	-	43	42.7	31.8	29.6	31	28.5	31.1	37	31.5	28	32.4
	Q4/92	-	-	-	-	-	-	-	-	-	-	-	-	-	-
	Q1/93	-	-	-	-	-	-	-	-	-	-	-	-	-	-
	Q2/93	-	-	-	21.4	19.4	18.1	11.2	10.6	9.5	7.2	5.3	4.3	3.5	3.8

Table 15		I-5 Downtown				Albro Pl. to Holgate St. , northbound a.m.									
Qtr.		6:00	6:15	6:30	6:45	7:00	7:15	7:30	7:45	8:00	8:15	8:30	8:45	9:00	9:15
GP Lanes	Q3/92	-	-	-	-	54.3	49.1	49.5	46.1	47.2	48.2	34.5	48.6	55.3	68.9
	Q4/92	-	-	-	-	-	-	-	-	-	27.6	28.3	26.2	27.8	29.1
	Q1/93	-	-	-	-	-	-	-	39.6	41.6	38.1	40.9	41.9	52.8	-
	Q2/93	-	-	-	-	-	-	-	-	-	-	-	-	-	-

Table 16		I-5 Downtown				Albro Pl. to Holgate St. , northbound p.m.									
Qtr.		3:00	3:15	3:30	3:45	4:00	4:15	4:30	4:45	5:00	5:15	5:30	5:45	6:00	6:15
GP Lanes	Q3/92	-	-	-	-	-	-	-	-	-	-	-	-	-	-
	Q4/92	-	-	-	-	-	-	-	-	-	-	-	-	-	-
	Q1/93	-	-	-	-	-	-	-	-	-	-	-	-	-	-
	Q2/93	-	-	-	42.9	39.2	30.6	34.3	30.3	17.9	19.4	19.3	33.9	30.2	26.1

Table 17		I-5 Downtown				Albro Pl. to S 144th St. , southbound p.m.									
Qtr.		3:00	3:15	3:30	3:45	4:00	4:15	4:30	4:45	5:00	5:15	5:30	5:45	6:00	6:15
GP Lanes	Q3/92	-	-	-	-	53.4	55.3	57.9	55.6	53.1	59.4	58.4	57.4	59.5	61.3
	Q4/92	-	-	-	-	39.1	53.8	61.6	-	-	-	-	-	-	-
	Q1/93	-	-	-	-	60.3	60.6	60.3	59.6	8.6	-	-	3.8	3.1	-
	Q2/93	-	-	-	76.3	75.2	73.1	71.6	73.4	73.9	74.2	73.2	71.9	70.3	-

Table 18		I-5 Downtown				S 144th St. to Lakeview E , northbound a.m.									
Qtr.		6:00	6:15	6:30	6:45	7:00	7:15	7:30	7:45	8:00	8:15	8:30	8:45	9:00	9:15
GP Lanes	Q3/92	-	-	-	-	-	-	-	-	-	-	-	-	-	-
	Q4/92	-	-	-	-	-	-	-	-	-	-	-	-	-	-
	Q1/93	-	-	-	-	-	-	-	-	-	-	-	-	-	-
	Q2/93	-	-	-	-	-	-	-	-	-	-	-	-	-	-

Table 19		I-5 Downtown				S 144th St. to Holgate St. , northbound a.m.									
Qtr.		6:00	6:15	6:30	6:45	7:00	7:15	7:30	7:45	8:00	8:15	8:30	8:45	9:00	9:15
GP Lanes	Q3/92	-	-	-	-	-	-	-	-	-	-	-	-	-	-
	Q4/92	-	-	-	-	-	-	-	-	-	-	-	-	-	-
	Q1/93	-	-	-	-	-	-	-	-	-	-	-	-	-	-
	Q2/93	-	-	-	-	-	-	-	-	-	-	-	-	-	-

Table 20		I-5 Downtown				S 144th St. to Albro Pl. , northbound a.m.									
Qtr.		6:00	6:15	6:30	6:45	7:00	7:15	7:30	7:45	8:00	8:15	8:30	8:45	9:00	9:15
GP Lanes	Q3/92	-	-	-	63.7	61.1	61.9	59.8	43.6	32	31.7	45.2	61.8	63.2	64.3
	Q4/92	-	-	-	-	-	-	-	-	52.8	57.6	37.1	54.4	5.7	-
	Q1/93	-	-	-	-	-	-	-	-	-	-	-	-	-	-
	Q2/93	-	-	-	-	-	-	-	-	-	-	-	-	-	-

# Travel Time Sites I-5 South (Corridor #3)

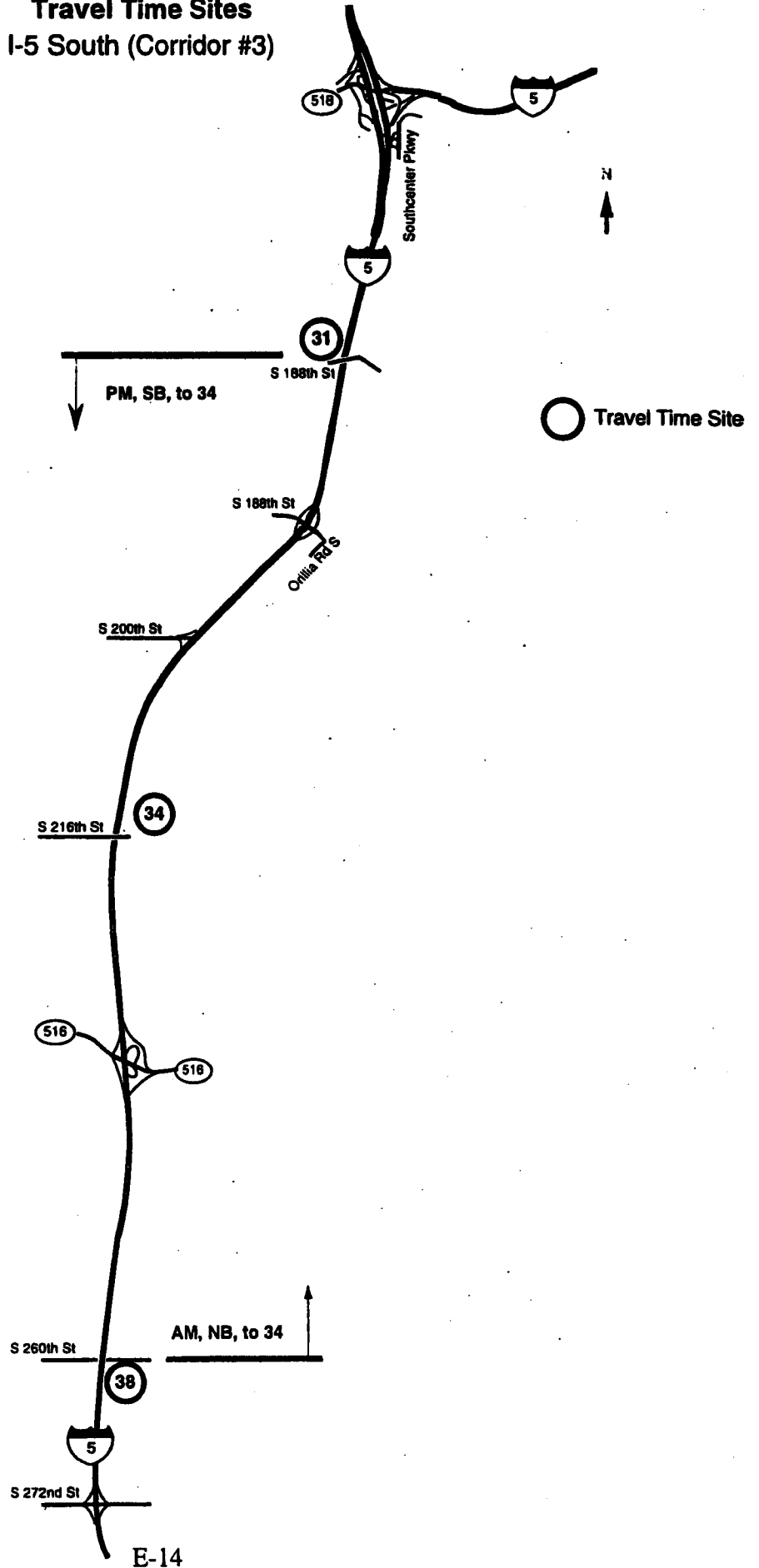

**I-5 SOUTH - S. 178th Street**

**SITE #31**

Travel times SB-pm

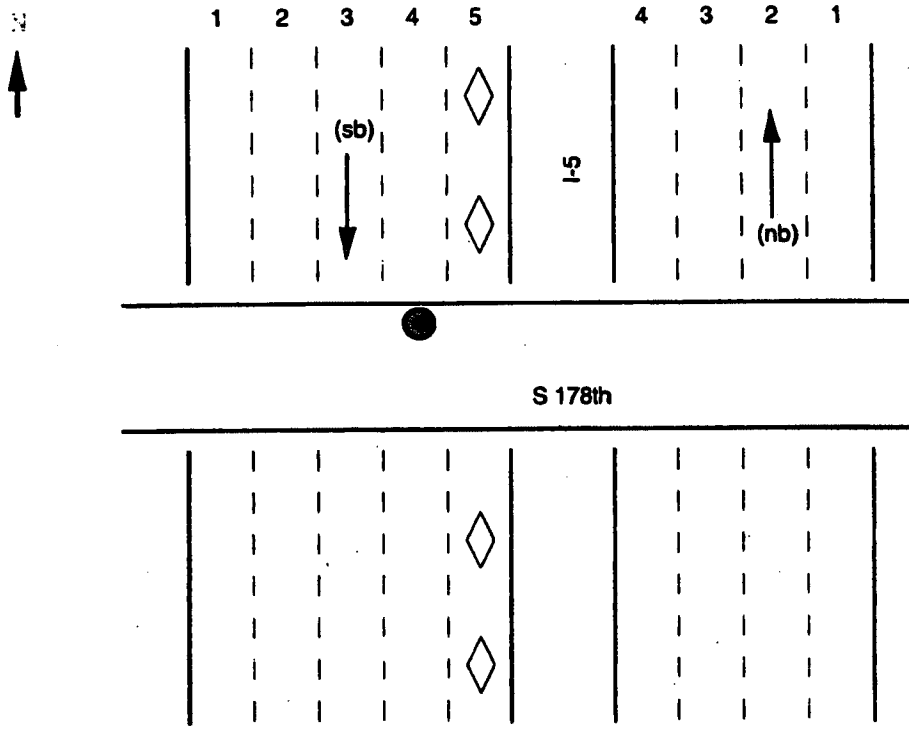

**I-5 SOUTH - South 216th Street**

**SITE #34**

Travel times NB-am & SB-pm

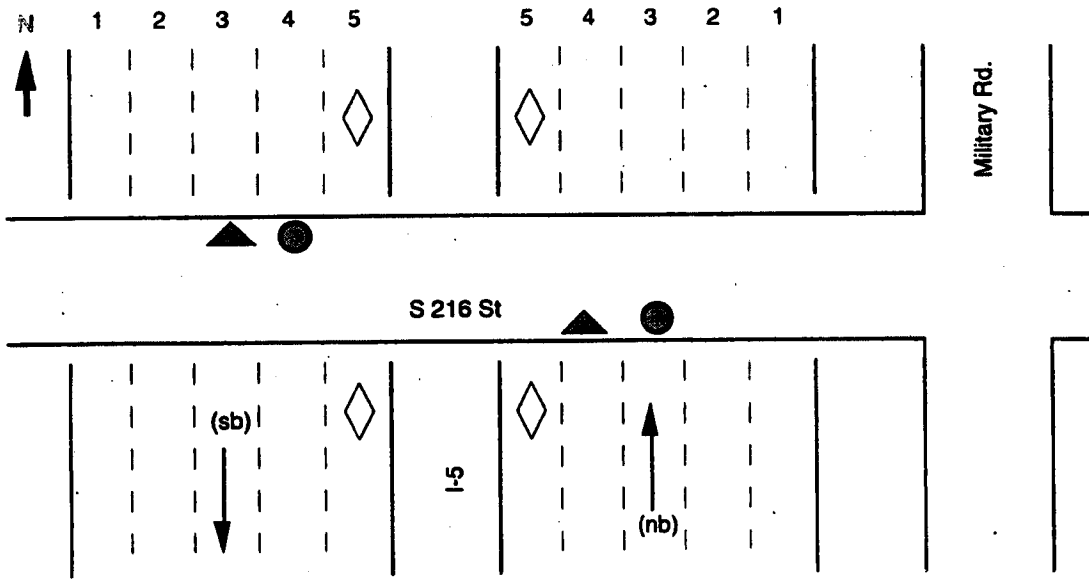

**Travel times NB-am**

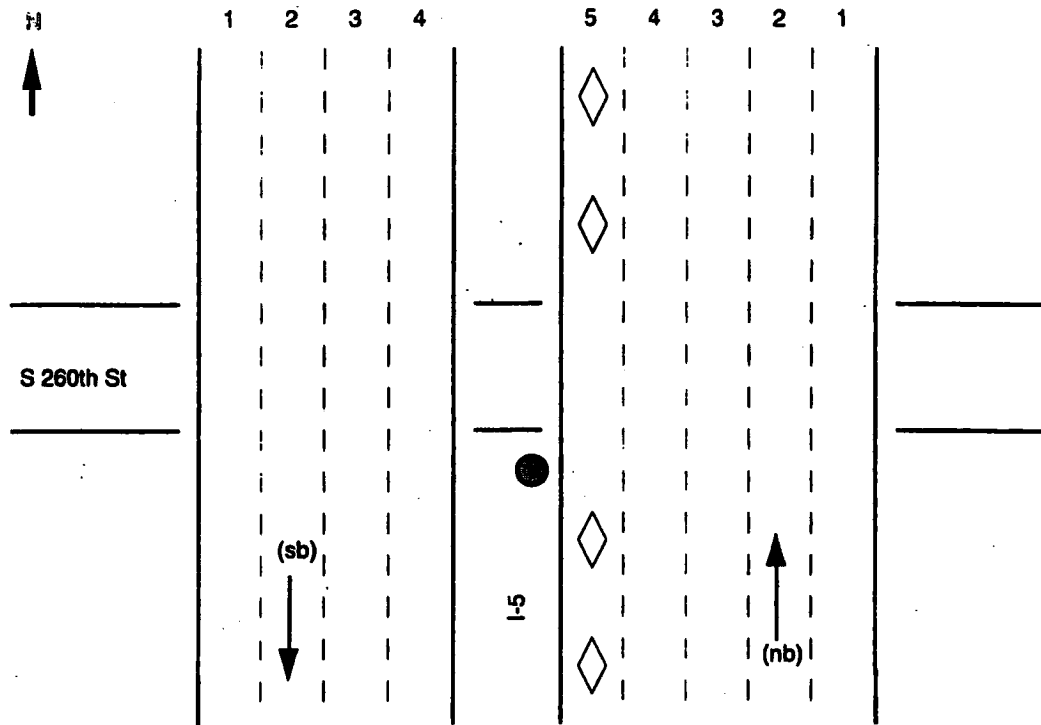

**Note:** You have to scramble up the hill on the south side of S. 260th and between the northbound and southbound freeway lanes. Climb over the fence at the top of the hill, and sit behind the jersey barrier at the edge of the freeway (the HOV and fast lanes northbound will be closest to you). Since you are in the freeway right-of-way at this location, you must wear a vest.

**Table 21 I-5 South S 178th St. to S 216th St. , southbound ..m.**

	Qtr.	3:45	4:00	4:15	4:30	4:45	5:00	5:15	5:30	5:45	6:00	6:15	6:30	6:45	7:00	7:15
GP Lanes	Q3/92	35.6	39.7	37.4	37.2	42.7	42	43.2	47.8	41.8	52.3	66.1	-	-	-	-
	Q4/92	-	18.2	17.7	20	19.2	-	-	-	-	-	-	-	-	-	-
	Q1/93	-	46.8	40.5	32.8	38.1	40.1	54	40.7	42	39.2	46.4	46.4	55.2	66.4	-
	Q2/93	8	40.4	35.2	40.6	40.3	39.3	38.1	39.1	36.2	30.6	20.7	22.2	37.5	60	62.4
HOV Lanes	Q3/92	41.2	33.2	38.4	43.1	36.9	38	35	45.2	45.7	49.7	55.7	73	-	-	-
	Q4/92	-	51.1	52.4	45.5	-	-	-	-	-	-	-	-	-	-	-
	Q1/93	-	-	47.6	30.7	31.3	46.2	40.4	42.3	37.5	39	36.7	37.8	-	57.8	-
	Q2/93	-	-	45.6	46.5	42.7	40.3	43.9	45.7	42.1	36.8	29.6	29.5	-	-	-

**Table 22 I-5 South S 260th St. to S 216th St. , northbound a.m.**

	Qtr.	6:00	6:15	6:30	6:45	7:00	7:15	7:30	7:45	8:00	8:15	8:30	8:45	9:00	9:15
GP Lanes	Q3/92	-	-	-	-	38.8	36	37.7	38.1	38.9	41.2	53.2	61.3	61.9	62.2
	Q4/92	-	-	-	-	-	-	-	21.8	26.9	33.8	55.8	61.1	-	-
	Q1/93	-	-	-	-	-	28.6	23.9	12.8	15.4	18.2	29.4	37.8	46.1	51.8
	Q2/93	-	-	-	-	61.3	56.4	47.3	41.4	40.1	51.5	47.8	36.5	-	-
HOV Lanes	Q3/92	-	-	-	-	-	53.5	50.4	51.4	50.5	50.4	58.6	57.7	-	-
	Q4/92	-	-	-	-	-	-	-	45	44.6	48.1	-	-	-	-
	Q1/93	-	-	-	-	-	-	40.1	44.6	42.4	46	45.4	49.4	39.4	-
	Q2/93	-	-	-	-	-	52.1	52.8	52.9	52.5	51.9	-	45.1	-	-

# Travel Time Sections SR 520 (Corridor #4)

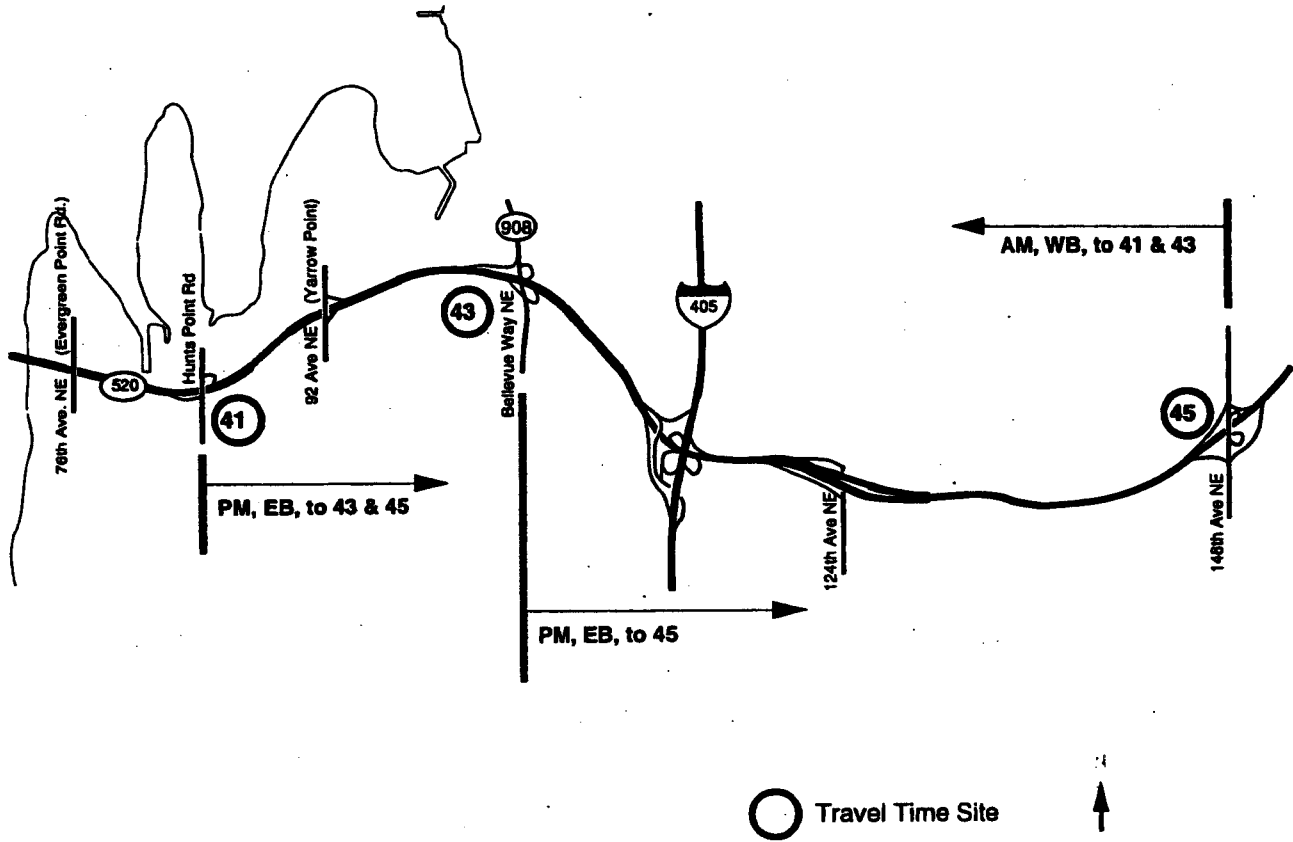

Travel times WB-am & EB-pm

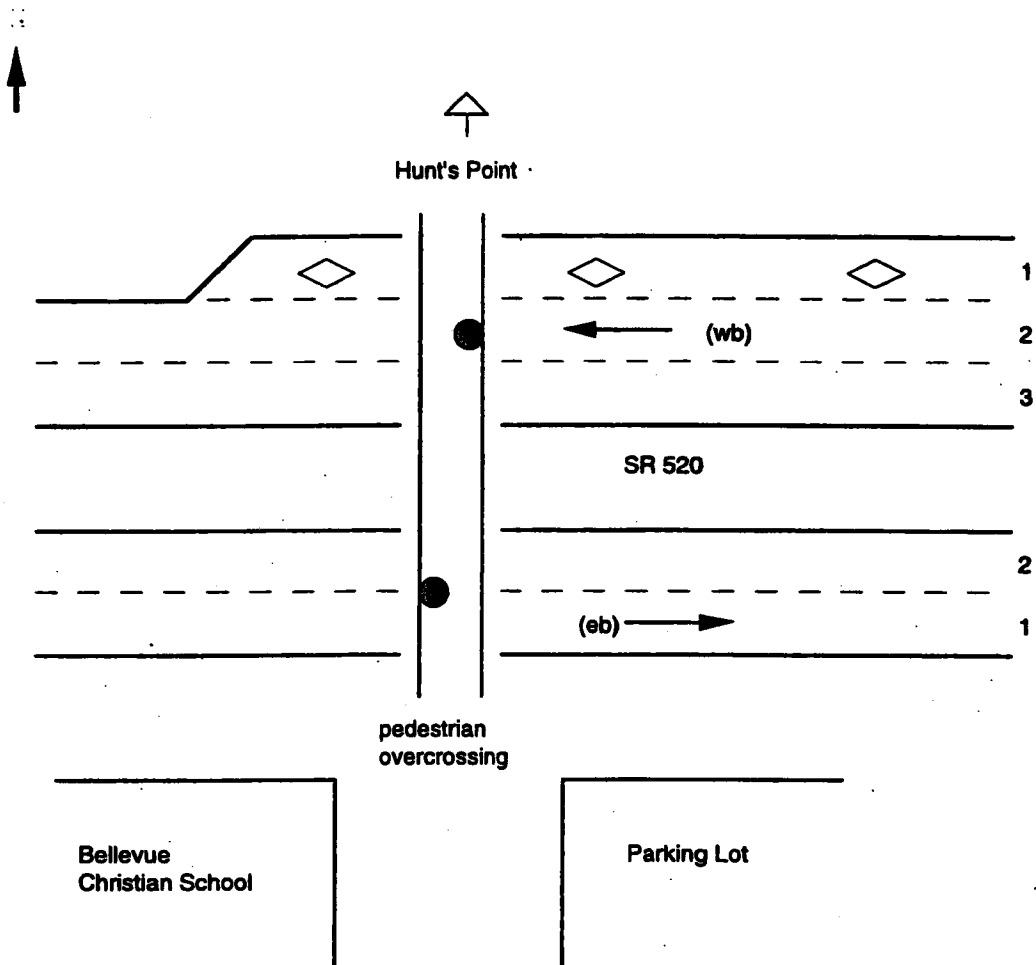

**Table 23 SR 520 Hunt's Pt. to SR 908 , westbound a.m.**

	Qtr.	6:00	6:15	6:30	6:45	7:00	7:15	7:30	7:45	8:00	8:15	8:30	8:45	9:00	9:15
GP Lanes	Q3/92	-	-	-	-	56.7	51.1	51.1	26.9	18	16.7	22.6	27.5	41	
	Q4/92	-	-	-	-	-	-	-	-	14.7	13.3	13.7	13.6	-	
	Q1/93	-	-	-	-	3.3	2.6	2.5	2.7	2.3	11.8	13.6	14.7	13.6	
	Q2/93	-	-	-	11.7	2.8	27.9	28.8	-	-	-	-	-	-	-
HOV Lanes	Q3/92	-	-	-	-	-	52.5	54.8	-	-	1	9.3	17.2	1.4	
	Q4/92	-	-	-	-	-	-	-	-	-	-	-	-	-	
	Q1/93	-	-	-	-	40	34.9	36.6	-	30.8	35.5	35.6	-	-	
	Q2/93	-	-	-	-	48.3	45.6	40.6	-	-	-	-	-	-	

**Table 24 SR 520 Hunt's Pt. to SR 908 , westbound p.m.**

	Qtr.	3:00	3:15	3:30	3:45	4:00	4:15	4:30	4:45	5:00	5:15	5:30	5:45	6:00	6:15
GP Lanes	Q3/92	-	-	55.9	55.8	56	56.8	51.3	38.8	38.9	24.4	22.4	12.3	11.2	11.4
	Q4/92	-	-	-	-	-	-	-	-	-	-	-	-	-	-
	Q1/93	-	-	-	-	-	-	-	-	-	-	-	-	-	-
	Q2/93	-	-	-	-	-	-	-	-	-	-	-	-	-	-
HOV Lanes	Q3/92	-	-	-	-	-	-	-	-	-	-	-	-	16.2	-
	Q4/92	-	-	-	-	-	-	-	-	-	-	-	-	-	-
	Q1/93	-	-	-	-	-	-	-	-	-	-	-	-	-	-
	Q2/93	-	-	-	-	-	-	-	-	-	-	-	-	-	-

Table 25		SR 520		Hunt's Pt. to 148th Ave. NE , westbound a.m.											
Qtr.		6:00	6:15	6:30	6:45	7:00	7:15	7:30	7:45	8:00	8:15	8:30	8:45	9:00	9:15
GP Lanes	Q3/92	-	-	-	-	-	-	-	-	-	-	-	-	-	-
	Q4/92	-	-	-	-	-	-	-	-	25.3	18.1	25.8	24.2	-	-
	Q1/93	-	-	-	-	-	-	-	-	-	-	-	-	-	-
	Q2/93	-	-	-	-	-	-	-	-	-	-	-	-	-	-

Table 26		SR 520		SR 908 to Hunt's Pt. , eastbound p.m.												
Qtr.		3:00	3:15	3:30	3:45	4:00	4:15	4:30	4:45	5:00	5:15	5:30	5:45	6:00	6:15	6:30
GP Lanes	Q3/92	-	-	56.2	53.6	49	50.2	51.4	53.5	48	48.6	49.7	50.2	49.9	46.2	57.2
	Q4/92	-	-	-	-	-	-	60.1	59.4	58.5	59.9	60.1	-	-	-	-
	Q1/93	-	-	-	-	-	52.6	54.1	53.1	52.4	54.2	51.2	52.6	52.3	48.6	-
	Q2/93	-	58.9	57.6	56.2	54.5	48	56.3	38	39.3	40.7	54.1	56.1	51.5	40.7	-

Table 27		SR 520		SR 908 to 148th Ave. NE , westbound a.m.											
Qtr.		6:00	6:15	6:30	6:45	7:00	7:15	7:30	7:45	8:00	8:15	8:30	8:45	9:00	9:15
GP Lanes	Q3/92	-	-	-	-	61.7	62.2	58.7	55.6	41.9	27.1	30.6	32.3	27	23.5
	Q4/92	-	-	-	-	-	-	-	30.8	30.7	30.4	37.4	33	12.2	-
	Q1/93	-	-	-	-	-	-	-	-	-	-	-	-	-	-
	Q2/93	-	-	-	-	14.2	42.2	9.1	5.9	3.3	2.5	2.2	1.8	1.6	1.5

Table 28		SR 520		148th Ave. NE to Hunt's Pt. , eastbound p.m.											
Qtr.		3:00	3:15	3:30	3:45	4:00	4:15	4:30	4:45	5:00	5:15	5:30	5:45	6:00	6:15
GP Lanes	Q3/92	-	-	-	55	54.3	54.8	56.1	54.8	54.2	49.8	52.2	53.2	54.8	56.7
	Q4/92	-	-	-	-	-	-	-	-	-	-	-	-	-	-
	Q1/93	-	-	-	-	-	-	-	-	-	-	-	-	-	-
	Q2/93	-	-	57.6	56.6	56.2	47.2	38.7	40.4	43.4	44.8	50.8	51.5	52.3	-

Table 29		SR 520		148th Ave. NE to SR 908 , eastbound p.m.												
Qtr.		3:00	3:15	3:30	3:45	4:00	4:15	4:30	4:45	5:00	5:15	5:30	5:45	6:00	6:15	6:30
GP Lanes	Q3/92	-	-	-	48.5	52.5	54.9	54	55.2	47.2	43.8	46.4	49.7	53.7	56.1	56.4
	Q4/92	-	-	-	-	-	-	-	-	-	-	-	-	-	-	-
	Q1/93	-	-	-	-	-	-	-	-	-	-	-	-	-	-	-
	Q2/93	-	-	58	57	57.8	58.3	59.4	57.4	56.5	57.2	56.5	49.5	50.5	-	-



**Travel Time Sections  
I-90 (Corridor #5)**

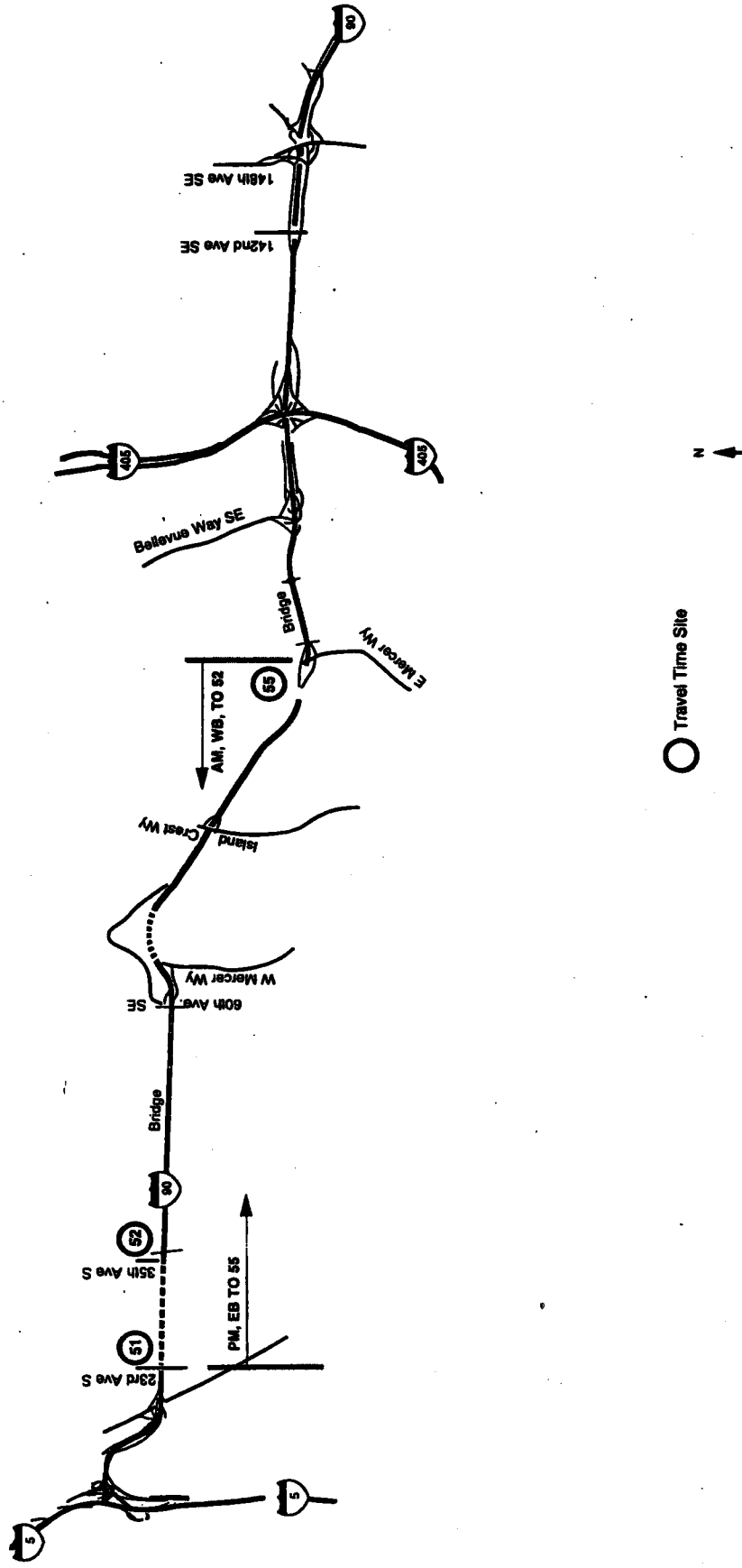

Travel times EB-pm

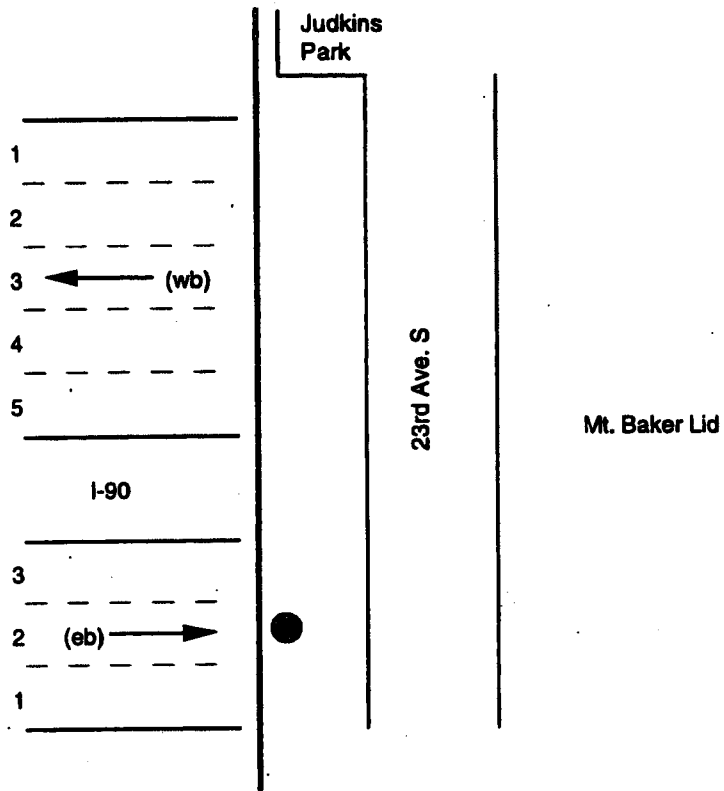

Note: The wall at the edge of the tunnel lid is about four feet high at this location, so you will have to stand to count.

Travel times WB-am



Mt. Baker Lid

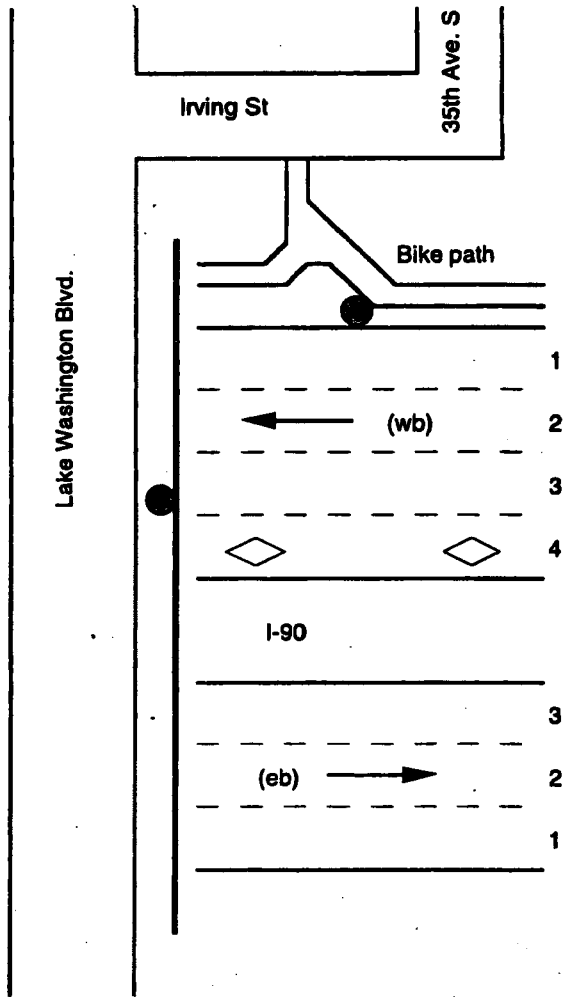

Note: You will have to look across several lanes of traffic in order to see license plates in the fast and HOV lanes at this location.

Travel times WB-am & EB-pm

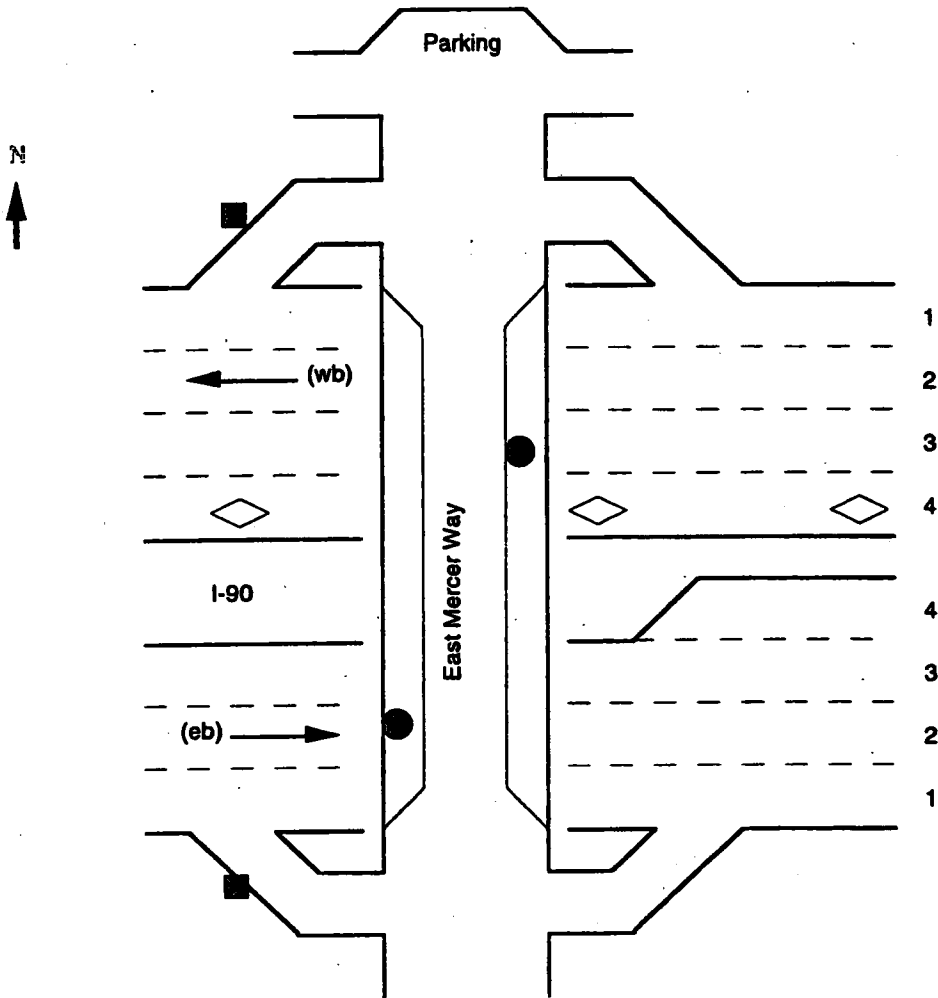

Travel times WB-am

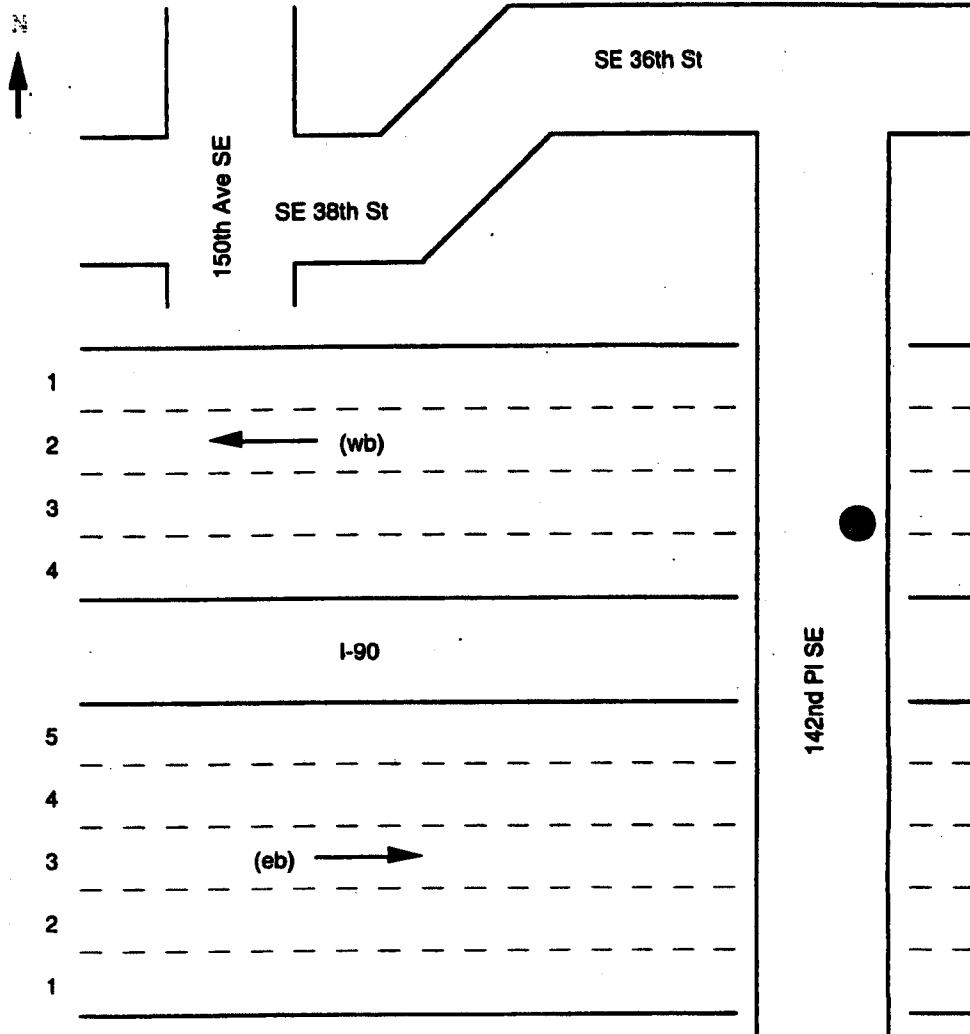

Travel times WB-am

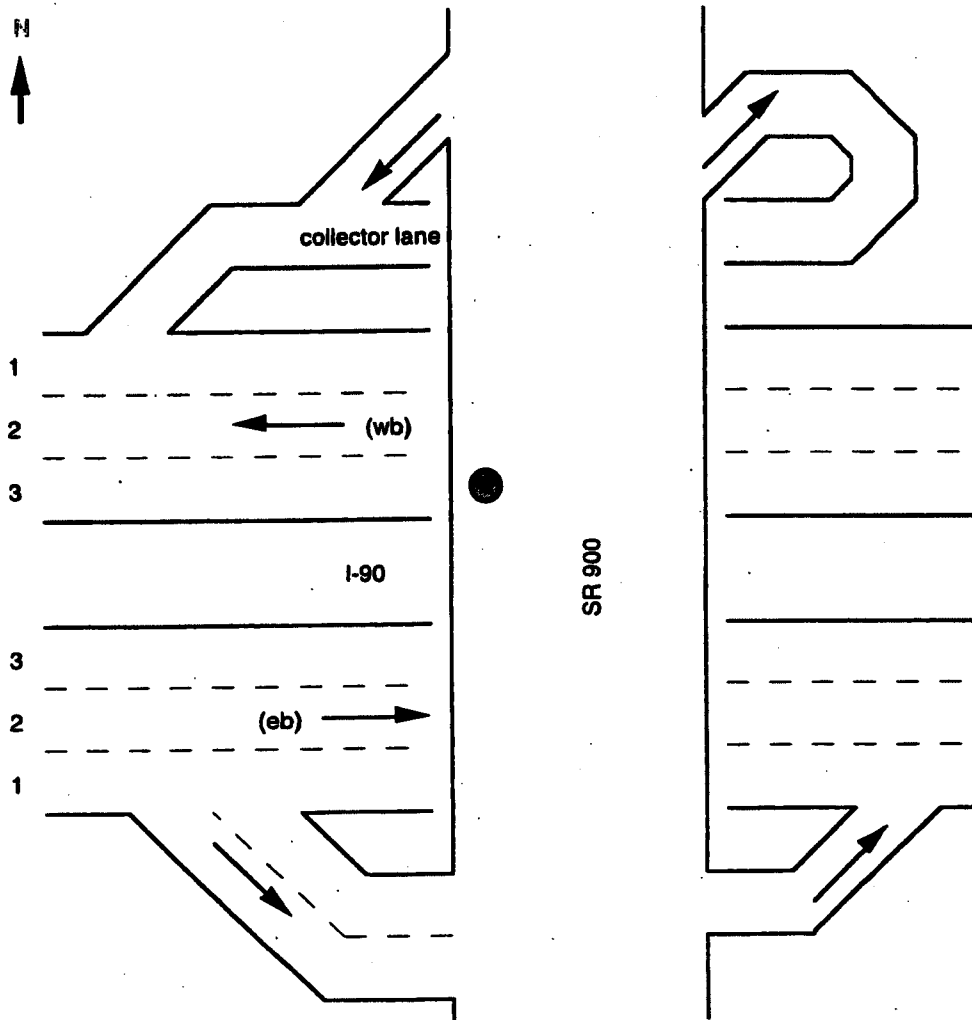

Note: Sidewalk is only on west side of SR 900

Note: The sidewalk is only on the west side of SR 900

Table	30	I-90	23rd Ave. S to East Mercer Way , eastbound p.m.												
	Qtr.	3:00	3:15	3:30	3:45	4:00	4:15	4:30	4:45	5:00	5:15	5:30	5:45	6:00	6:15
GP Lanes	Q3/92	-	-	12.9	21.2	33.5	43.5	49.2	45.7	49.5	54.9	53.2	42	44.5	27.6
	Q4/92	-	-	-	-	36	55.9	50.9	52.2	-	-	-	-	-	-
	Q1/93	-	-	-	-	-	-	-	-	-	-	-	-	-	-
	Q2/93	-	-	-	58.4	56.9	55.6	55.1	54.1	51.8	43.7	44.5	45	47.6	43.4

Table	31	I-90	East Mercer Way to 35th Ave. S , westbound a.m.												
	Qtr.	6:00	6:15	6:30	6:45	7:00	7:15	7:30	7:45	8:00	8:15	8:30	8:45	9:00	9:15
GP Lanes	Q3/92	-	-	-	-	57.1	57.1	54.6	51.6	45.2	42.2	50.8	50	55.7	59.2
	Q4/92	-	-	-	-	-	-	-	-	-	-	-	-	-	-
	Q1/93	-	-	-	-	-	2.5	1.6	20.7	38.7	9.7	27.4	35	-	-
	Q2/93	-	-	-	-	57.9	58.2	56.4	54.7	51.4	52.6	57.4	57.8	-	-
HOV Lanes	Q3/92	-	-	-	-	48.5	53.6	52	50.9	52.1	54.7	53.2	54.9	54.1	59.6
	Q4/92	-	-	-	-	-	-	-	-	-	-	-	-	-	-
	Q1/93	-	-	-	-	-	42.1	43	43.4	46.7	44.7	51.1	54.4	-	-
	Q2/93	-	-	-	-	52.1	55.8	54.6	53	52.3	52.9	54	55.2	-	-

# Travel Time Sections I-405 South

○ Travel Time Site

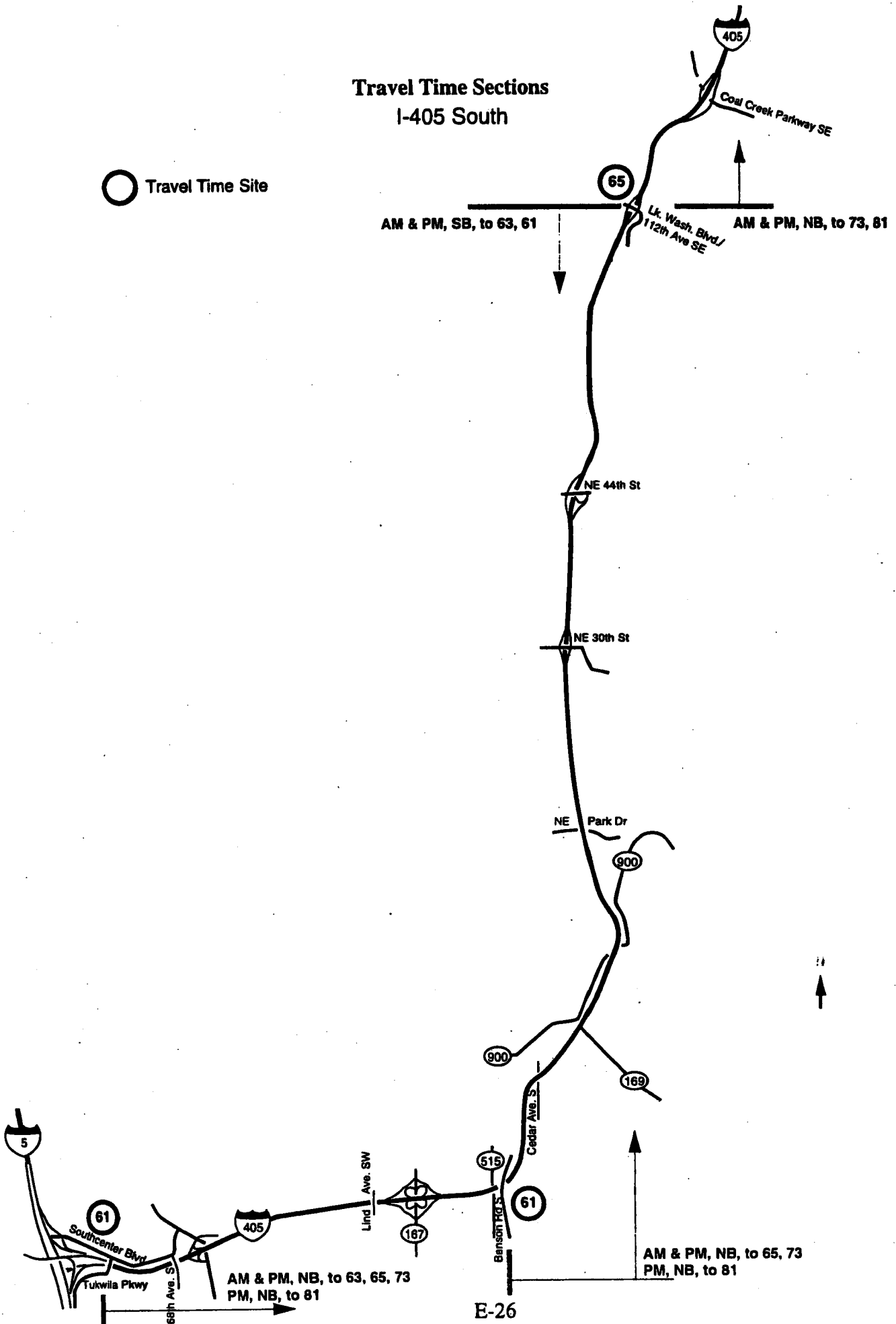

Travel times NB & SB-am & pm

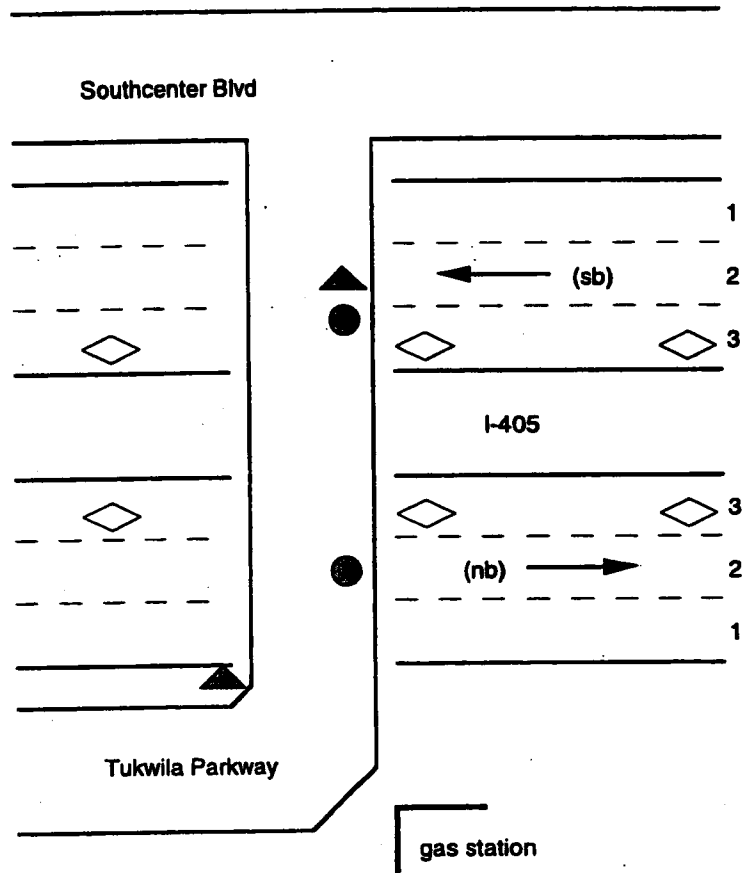



Travel times NB & SB-am & pm

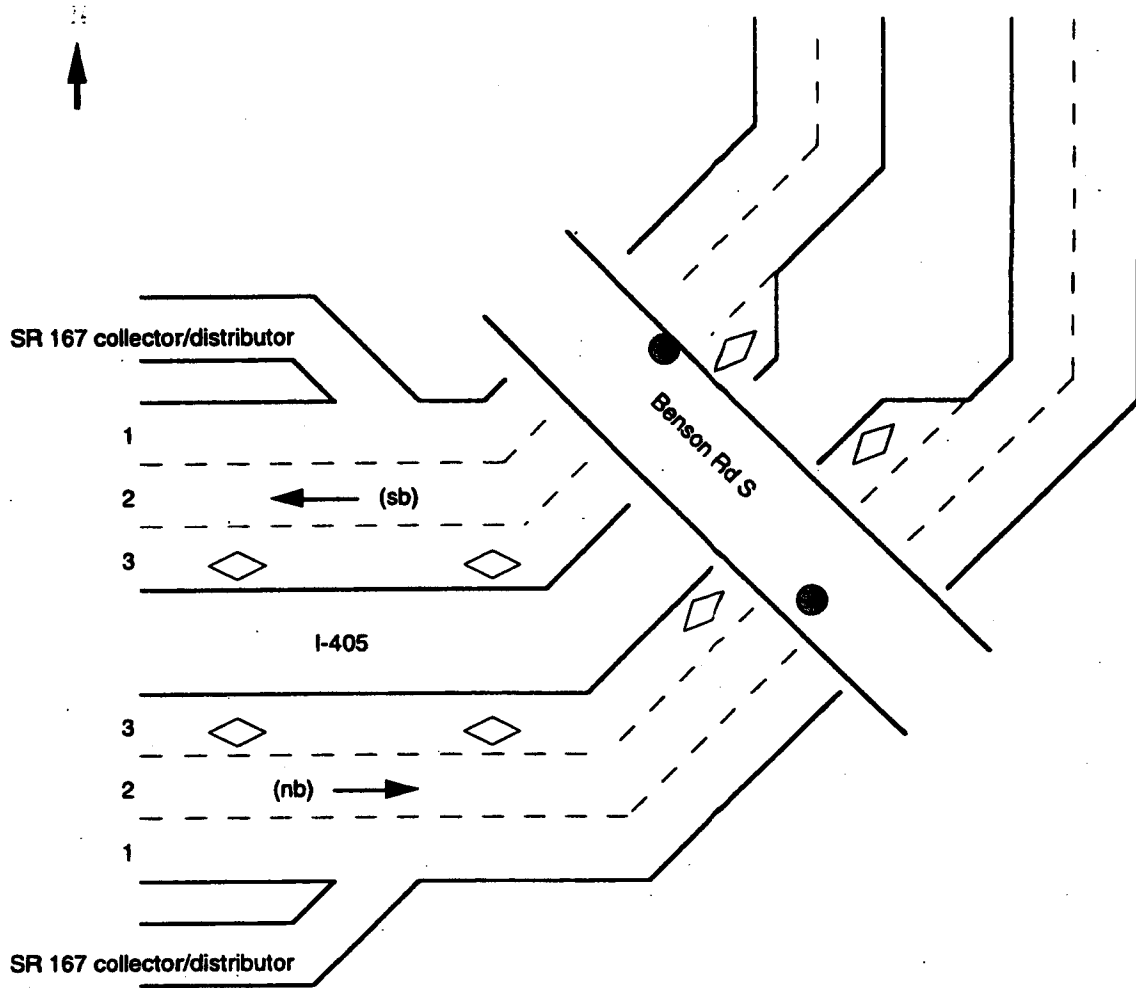

**Note:** There is a wide sidewalk on the west side of this overpass, and a very narrow one on the east side. If you are counting southbound traffic on the narrow sidewalk, it is a good idea to wear a vest in this location.

Travel times NB & SB-am & pm

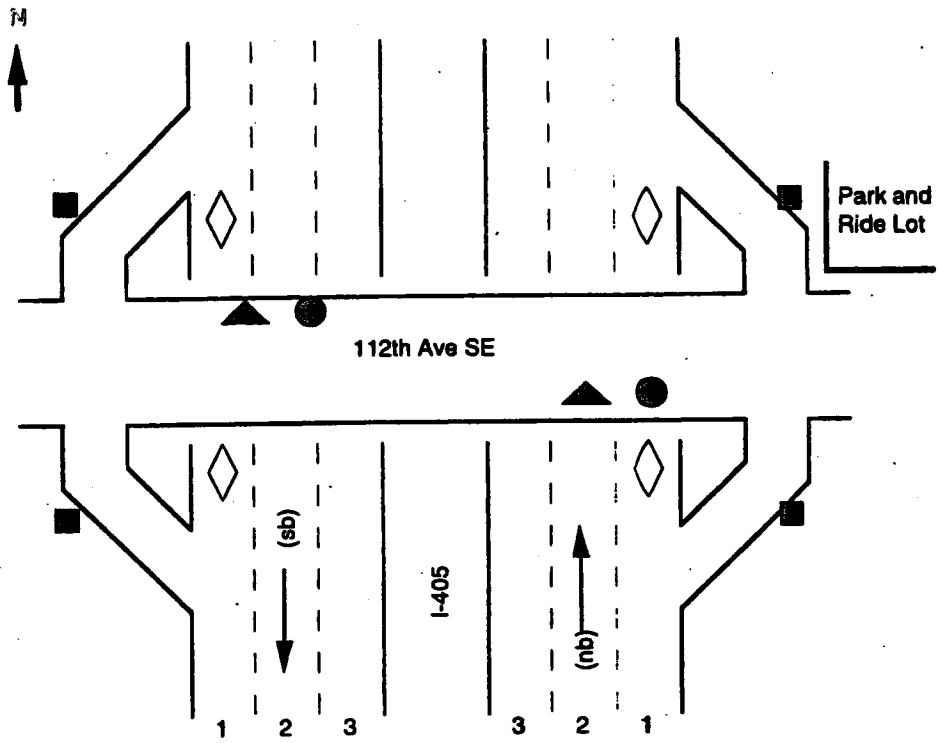

# Travel Time Sections I-405 North

○ Travel Time Site

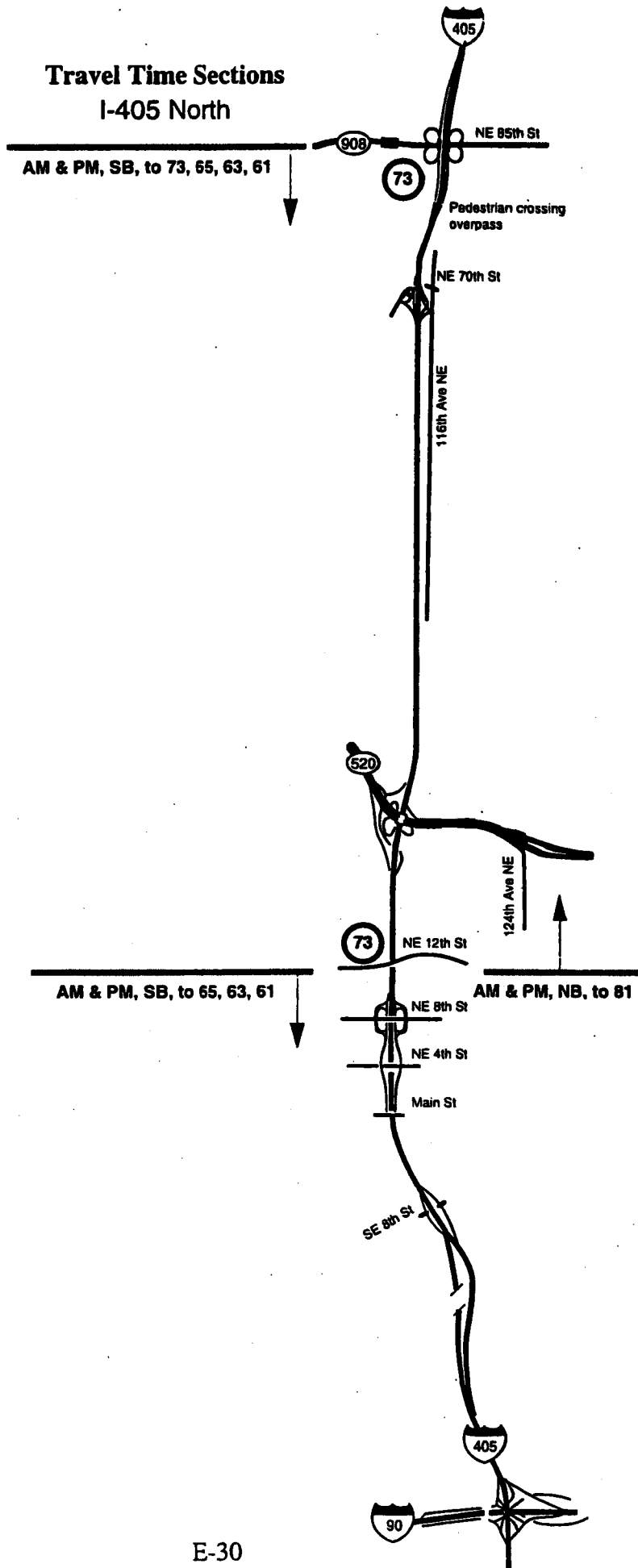

**I-405 CENTRAL - NE 12th Street**

**SITE #73**

Travel times NB & SB-am & pm

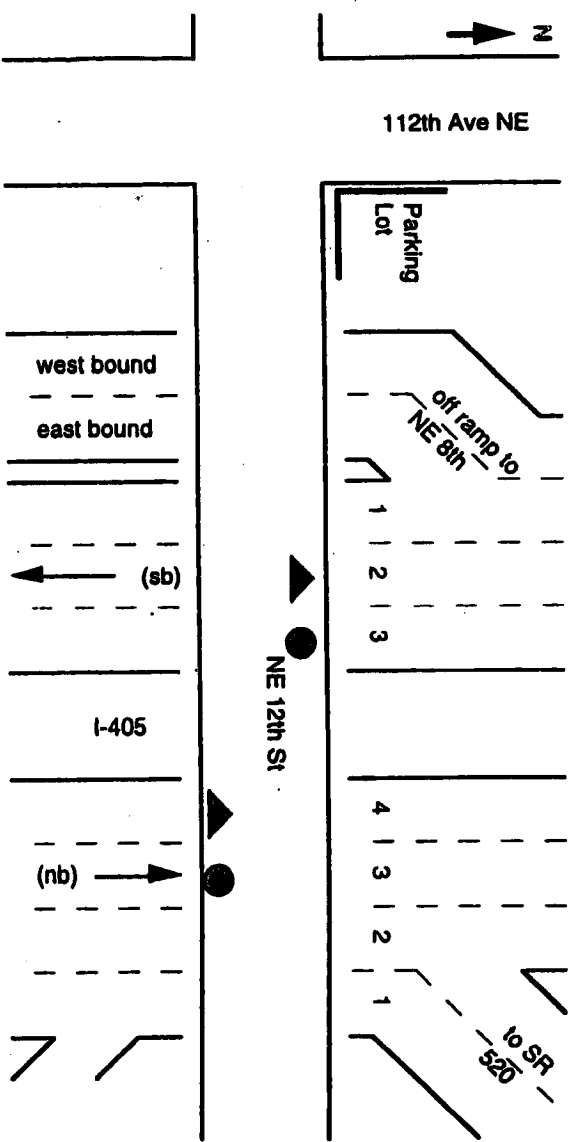

**I-405 NORTH - SR 908: Central Way/NE 85th**

**SITE #81**

Travel times SB-am & NB-pm

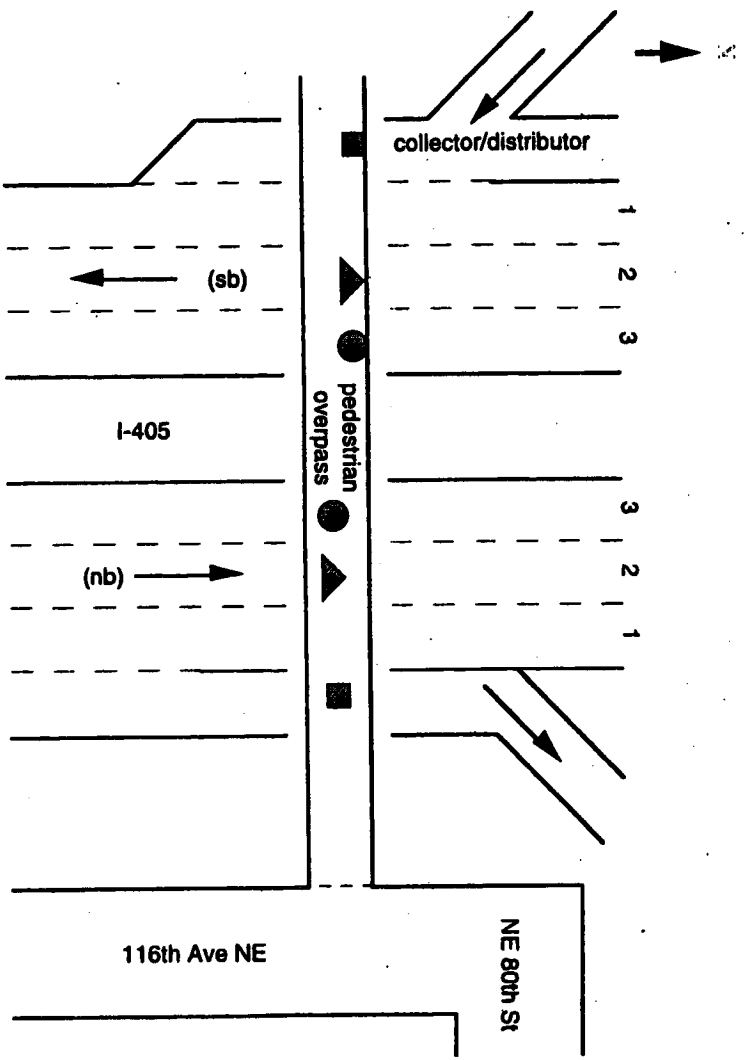

Table 32		I-405		Tukwila Pkwy. to Benson Rd. S , northbound a.m.											
Qtr.		6:00	6:15	6:30	6:45	7:00	7:15	7:30	7:45	8:00	8:15	8:30	8:45	9:00	9:15
GP Lanes	Q3/92	-	-	-	-	-	-	-	-	-	-	-	-	-	-
	Q4/92	-	-	-	-	-	-	-	-	-	-	-	-	-	-
	Q1/93	-	-	-	-	-	62.8	53.6	42.3	48.4	61.4	62.8	62.1	-	-
	Q2/93	-	-	-	-	-	-	-	-	-	-	-	-	-	-
HOV Lanes	Q3/92	-	-	-	-	-	-	-	-	-	-	-	-	-	-
	Q4/92	-	-	-	-	-	-	-	-	-	-	-	-	-	-
	Q1/93	-	-	-	-	-	-	-	52.1	-	-	-	-	-	-
	Q2/93	-	-	-	-	-	-	-	-	-	-	-	-	-	-

Table 33		I-405		Tukwila Pkwy. to Benson Rd. S , northbound p.m.												
Qtr.		3:00	3:15	3:30	3:45	4:00	4:15	4:30	4:45	5:00	5:15	5:30	5:45	6:00	6:15	6:30
GP Lanes	Q3/92	-	-	-	-	28.2	33.6	36.4	26.4	23.6	22.6	24.9	16.4	17.1	8.6	2
	Q4/92	-	-	-	-	3.9	31.5	33.7	-	-	-	-	-	-	-	-
	Q1/93	-	-	-	-	-	-	-	-	-	-	-	-	-	-	-
	Q2/93	-	-	-	-	-	-	-	-	1.7	-	-	-	1	-	-
HOV Lanes	Q3/92	-	-	-	-	-	-	-	-	-	-	2.2	-	-	2.2	-
	Q4/92	-	-	-	-	-	-	-	-	-	-	-	-	-	-	-
	Q1/93	-	-	-	-	-	-	-	-	-	-	-	-	-	-	-
	Q2/93	-	-	-	-	-	-	-	-	-	-	-	-	-	-	-

Table 34		I-405		Tukwila Pkwy. to 112th Ave SE , northbound a.m.											
Qtr.		6:00	6:15	6:30	6:45	7:00	7:15	7:30	7:45	8:00	8:15	8:30	8:45	9:00	9:15
GP Lanes	Q3/92	-	-	-	-	-	-	-	-	-	-	-	-	-	-
	Q4/92	-	-	-	-	-	-	-	-	-	-	-	-	-	-
	Q1/93	-	-	-	-	-	-	51.9	-	-	-	-	-	-	-
	Q2/93	-	-	-	-	-	-	-	-	-	-	-	-	-	-

Table 35		I-405		Tukwila Pkwy. to 112th Ave SE , northbound p.m.											
Qtr.		3:00	3:15	3:30	3:45	4:00	4:15	4:30	4:45	5:00	5:15	5:30	5:45	6:00	6:15
GP Lanes	Q3/92	-	-	-	-	-	-	-	-	-	-	-	-	-	-
	Q4/92	-	-	-	-	-	-	-	-	-	-	-	-	-	-
	Q1/93	-	-	-	-	-	-	-	-	-	-	-	-	-	-
	Q2/93	-	-	-	-	-	-	-	-	-	-	-	-	-	-

Table 36		I-405		Tukwila Pkwy. to NE 12th St. , northbound a.m.											
Qtr.		6:00	6:15	6:30	6:45	7:00	7:15	7:30	7:45	8:00	8:15	8:30	8:45	9:00	9:15
GP Lanes	Q3/92	-	-	-	-	-	-	-	-	-	-	-	-	-	-
	Q4/92	-	-	-	-	-	-	-	-	-	-	-	-	-	-
	Q1/93	-	-	-	-	-	-	14.8	-	-	-	-	-	-	-
	Q2/93	-	-	-	-	-	-	-	-	-	-	-	-	-	-

Table 37		I-405		Tukwila Pkwy. to NE 12th St. , northbound p.m.											
Qtr.		3:00	3:15	3:30	3:45	4:00	4:15	4:30	4:45	5:00	5:15	5:30	5:45	6:00	6:15
GP Lanes	Q3/92	-	-	-	-	-	-	-	-	-	-	-	-	-	-
	Q4/92	-	-	-	-	-	-	-	-	-	-	-	-	-	-
	Q1/93	-	-	-	-	-	-	-	-	-	-	-	-	-	-
	Q2/93	-	-	-	-	-	-	-	-	-	-	-	-	-	-

Table 38		I-405		Tukwila Pkwy. to SR 908 , northbound p.m.											
Qtr.		3:00	3:15	3:30	3:45	4:00	4:15	4:30	4:45	5:00	5:15	5:30	5:45	6:00	6:15
GP Lanes	Q3/92	-	-	-	-	-	-	-	-	-	-	-	-	-	-
	Q4/92	-	-	-	-	-	-	-	-	-	-	-	-	-	-
	Q1/93	-	-	-	-	-	-	-	-	-	-	-	-	-	-
	Q2/93	-	-	-	-	-	-	-	-	-	-	-	-	-	-

Table	39	I-405	Benson Rd. S to Tukwila Pkwy. , southbound a.m.												
	Qtr.	6:00	6:15	6:30	6:45	7:00	7:15	7:30	7:45	8:00	8:15	8:30	8:45	9:00	9:15
GP Lanes	Q3/92	-	-	-	-	-	33.2	33.6	31.4	32.9	30.6	31.4	34.3	33.8	33.3
	Q4/92	-	-	-	-	-	-	-	-	-	-	-	-	-	-
	Q1/93	-	-	-	-	-	-	-	-	-	-	-	-	-	-
	Q2/93	-	-	-	-	-	52.5	55.7	48.6	51.1	44.6	49.7	56.7	-	-
HOV Lanes	Q3/92	-	-	-	-	-	-	-	-	-	-	-	-	-	-
	Q4/92	-	-	-	-	-	-	-	-	-	-	-	-	-	-
	Q1/93	-	-	-	-	-	-	-	-	-	-	-	-	-	-
	Q2/93	-	-	-	-	-	-	-	-	3.7	-	-	-	-	-

Table	40	I-405	Benson Rd. S to Tukwila Pkwy. , southbound p.m.												
	Qtr.	3:00	3:15	3:30	3:45	4:00	4:15	4:30	4:45	5:00	5:15	5:30	5:45	6:00	6:15
GP Lanes	Q3/92	-	-	-	-	-	-	-	-	-	-	-	-	-	-
	Q4/92	-	-	-	-	-	-	12.2	15.6	3	11.1	1.7	-	-	-
	Q1/93	-	-	-	-	1.4	17.5	27.2	-	-	-	-	-	-	-
	Q2/93	-	-	-	-	58.2	59.2	56.5	59.2	58	58.8	59	58.3	60.1	-
HOV Lanes	Q3/92	-	-	-	-	-	-	-	-	-	-	-	-	-	-
	Q4/92	-	-	-	-	-	-	-	-	-	-	-	-	-	-
	Q1/93	-	-	-	-	1	-	1.2	-	-	-	-	-	-	-
	Q2/93	-	-	-	-	-	-	-	-	-	-	-	64.3	-	-

Table	41	I-405	Benson Rd. S to 112th Ave SE , northbound a.m.												
	Qtr.	6:00	6:15	6:30	6:45	7:00	7:15	7:30	7:45	8:00	8:15	8:30	8:45	9:00	9:15
GP Lanes	Q3/92	-	-	-	-	-	-	-	-	-	-	-	-	-	-
	Q4/92	-	-	-	-	-	-	-	-	-	-	-	-	-	-
	Q1/93	-	-	-	-	-	-	-	41.5	36.2	46.2	56.3	55.9	-	-
	Q2/93	-	-	-	-	-	-	-	-	-	-	-	-	-	-

Table	42	I-405	Benson Rd. S to 112th Ave SE , northbound p.m.												
	Qtr.	3:00	3:15	3:30	3:45	4:00	4:15	4:30	4:45	5:00	5:15	5:30	5:45	6:00	6:15
GP Lanes	Q3/92	-	-	-	-	-	-	-	-	-	32.9	26.9	31.4	28.2	33.9
	Q4/92	-	-	-	-	-	-	-	-	-	-	-	-	-	-
	Q1/93	-	-	-	-	-	-	-	-	-	-	-	-	-	-
	Q2/93	-	-	-	48.6	46.7	48.9	43.8	49.9	50	51.9	51.6	52.7	52.9	-

Table	43	I-405	Benson Rd. S to NE 12th St. , northbound a.m.												
	Qtr.	6:00	6:15	6:30	6:45	7:00	7:15	7:30	7:45	8:00	8:15	8:30	8:45	9:00	9:15
GP Lanes	Q3/92	-	-	-	-	-	-	61.7	-	58.4	-	57	56.1	57.4	-
	Q4/92	-	-	-	-	-	-	-	-	-	-	-	-	-	-
	Q1/93	-	-	-	-	-	-	-	30.8	36.3	53.9	72.3	-	-	-
	Q2/93	-	-	-	-	-	-	-	-	-	-	-	-	-	-

Table	44	I-405	Benson Rd. S to NE 12th St. , northbound p.m.												
	Qtr.	3:00	3:15	3:30	3:45	4:00	4:15	4:30	4:45	5:00	5:15	5:30	5:45	6:00	6:15
GP Lanes	Q3/92	-	-	-	-	-	-	-	-	-	15.9	17.5	19.6	18	15.6
	Q4/92	-	-	-	-	-	-	-	-	-	-	-	-	-	-
	Q1/93	-	-	-	-	-	-	-	-	-	-	-	-	-	-
	Q2/93	-	-	-	-	-	-	-	-	-	-	-	-	-	-

Table	45	I-405	Benson Rd. S to SR 908 , northbound p.m.												
	Qtr.	3:00	3:15	3:30	3:45	4:00	4:15	4:30	4:45	5:00	5:15	5:30	5:45	6:00	6:15
GP Lanes	Q3/92	-	-	-	-	-	-	-	-	-	-	-	-	-	-
	Q4/92	-	-	-	-	-	-	-	-	-	-	-	-	-	-
	Q1/93	-	-	-	-	-	-	-	-	-	-	-	-	-	-
	Q2/93	-	-	-	-	-	-	-	-	-	-	-	-	-	-

Table 46		I-405		112th Ave SE to Tukwila Pkwy. , southbound a.m.													
Qtr.		6:00	6:15	6:30	6:45	7:00	7:15	7:30	7:45	8:00	8:15	8:30	8:45	9:00	9:15	9:30	
GP Lanes	Q3/92	-	-	-	-	-	21.1	26.4	25.1	26.6	28.9	41.5	50	57.3	-	-	
	Q4/92	-	-	-	-	-	-	-	-	-	-	-	-	-	-	-	
	Q1/93	-	-	-	-	-	-	-	-	-	-	-	-	-	-	-	
	Q2/93	-	-	-	-	-	-	-	-	-	-	-	-	-	-	-	

Table 47		I-405		112th Ave SE to Tukwila Pkwy. , southbound p.m.													
Qtr.		3:00	3:15	3:30	3:45	4:00	4:15	4:30	4:45	5:00	5:15	5:30	5:45	6:00	6:15	6:30	
GP Lanes	Q3/92	-	-	-	-	-	-	-	-	-	-	-	-	-	-	-	
	Q4/92	-	-	-	-	-	-	20.8	-	-	-	-	-	-	-	-	
	Q1/93	-	-	-	-	-	-	-	-	-	-	-	-	-	-	-	
	Q2/93	-	-	-	-	-	-	-	-	-	-	-	-	-	-	-	

Table 48		I-405		112th Ave SE to Benson Rd. S , southbound a.m.													
Qtr.		6:00	6:15	6:30	6:45	7:00	7:15	7:30	7:45	8:00	8:15	8:30	8:45	9:00	9:15	9:30	
GP Lanes	Q3/92	-	-	-	-	-	-	-	-	-	-	-	-	-	-	-	
	Q4/92	-	-	-	-	-	-	41	39.4	37.5	-	-	-	-	-	-	
	Q1/93	-	-	-	-	-	-	-	-	-	-	-	-	-	-	-	
	Q2/93	-	-	-	-	-	-	-	-	-	-	-	-	-	-	-	

Table 49		I-405		112th Ave SE to Benson Rd. S , southbound p.m.													
Qtr.		3:00	3:15	3:30	3:45	4:00	4:15	4:30	4:45	5:00	5:15	5:30	5:45	6:00	6:15	6:30	
GP Lanes	Q3/92	-	-	-	-	-	-	-	-	-	-	-	-	-	-	-	
	Q4/92	-	-	-	-	-	-	-	12.5	13.9	-	-	-	-	-	-	
	Q1/93	-	-	-	-	-	-	-	-	-	-	-	-	-	-	-	
	Q2/93	-	-	-	15.1	16.4	-	-	-	-	-	-	-	-	-	-	

Table 50		I-405		112th Ave SE to NE 12th St. , northbound a.m.													
Qtr.		6:00	6:15	6:30	6:45	7:00	7:15	7:30	7:45	8:00	8:15	8:30	8:45	9:00	9:15	9:30	
GP Lanes	Q3/92	-	-	-	-	43.5	-	34.7	-	-	23.9	23.7	22.4	23.1	-	-	
	Q4/92	-	-	-	-	-	-	-	-	-	-	-	-	-	-	-	
	Q1/93	-	-	-	-	-	-	-	-	55.5	45.8	56.5	63	-	-	-	
	Q2/93	-	-	-	-	-	-	-	-	-	-	-	-	-	-	-	

**APPENDIX F**

**HOVTT (FCM) TRAVEL TIME**



**Travel Time Sections  
I-5 North**

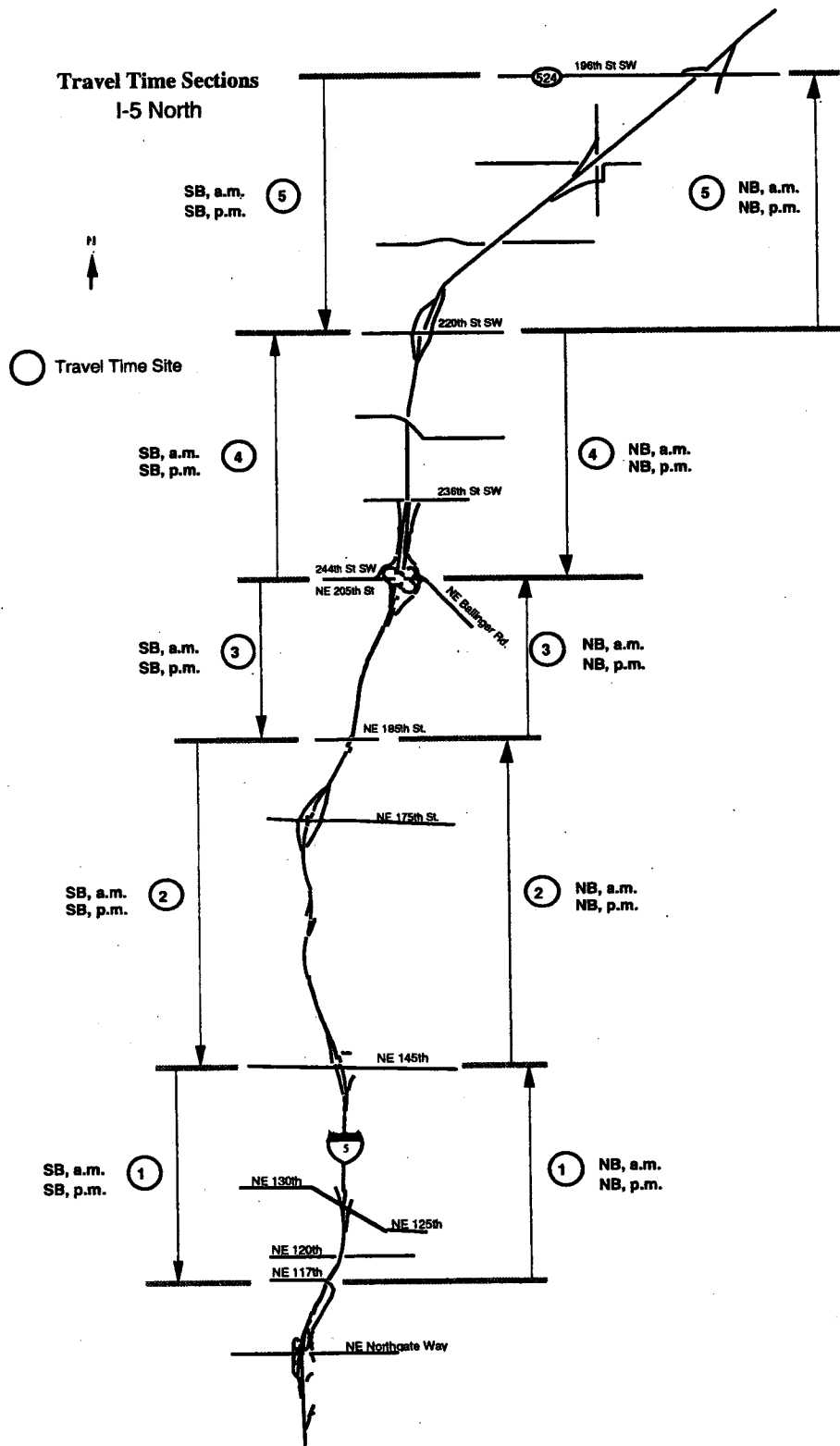

**NORTH I-5 CORRIDOR, A.M. SOUTHBOUND**

**1) NE 145th St. Overpass to NE 117th St. Overpass**

Quarter	Min.	Max	Median	Avg.	SD	Speed (mph) >90%	Percent >45 mph	Number of Data Points
Q4/95	25	65	46	45	10	32	51.9%	28
Q1/96	32	63	57	55	6	46	93.6%	32
Q2/96	45	63	58	57	5	49	100.0%	30
Q3/96	No Data	No Data	No Data	No Data	No Data	No Data	No Data	No Data
Q4/96	30	63	46	47	9	33	63.9%	22
Q1/97	14	64	51	49	11	35	70.0%	32
Q2/97 & Q3/97	No Data Collected							
Q4/97	21	67	55	53	11	39	83.3%	66
Q1/98	8	66	56	52	12	37	75.4%	69

**2) NE 185th St. Overpass to NE 145th St. Overpass**

Quarter	Min.	Max	Median	Avg.	SD	Speed (mph) >90%	Percent >45 mph	Number of Data Points
Q4/95	21	62	48	48	9	39	66.7%	28
Q1/96	37	65	57	55	5	51	96.2%	32
Q2/96	51	64	60	58	4	52	100.0%	30
Q3/96	No Data	No Data	No Data	No Data	No Data	No Data	No Data	No Data
Q4/96	22	63	49	49	10	37	66.1%	22
Q1/97	17	64	53	50	11	36	81.3%	32
Q2/97 & Q3/97	No Data Collected							
Q4/97	14	68	55	53	11	40	82.6%	69
Q1/98	25	69	58	54	10	37	79.4%	68

**3) SR 104 Interchange (NE 205th St.) to NE 185th St. Overpass**

Quarter	Min.	Max	Median	Avg.	SD	Speed (mph) >90%	Percent >45 mph	Number of Data Points
Q4/95	24	64	46	46	10	35	55.6%	28
Q1/96	21	62	57	52	9	42	82.6%	32
Q2/96	34	67	59	55	9	42	79.4%	30
Q3/96	No Data	No Data	No Data	No Data	No Data	No Data	No Data	No Data
Q4/96	24	65	54	51	12	39	74.6%	21
Q1/97	23	66	52	50	11	30	74.1%	32
Q2/97 & Q3/97	No Data Collected							
Q4/97	18	65	54	53	10	43	87.0%	69
Q1/98	11	69	54	54	11	39	80.9%	68

**NORTH I-5 CORRIDOR, A.M. SOUTHBOUND**

**4) 220th St. Overpass to SR 104 Interchange (NE 205th St.)**

Quarter	Min.	Max	Median	Avg.	SD	Speed (mph) >90%	Percent >45 mph	Number of Data Points
Q4/95	19	69	47	49	13	37	59.3%	28
Q1/96	18	64	59	56	10	46	91.0%	32
Q2/96	38	66	62	59	7	51	96.6%	30
Q3/96	No Data	No Data	No Data	No Data	No Data	No Data	No Data	No Data
Q4/96	14	66	57	52	13	30	77.1%	21
Q1/97	27	70	58	56	10	42	87.4%	32
Q2/97 & Q3/97	No Data Collected							
Q4/97	21	68	59	56	10	45	91.3%	69
Q1/98	23	70	62	58	9	46	92.5%	67

**5) SR 524 Overpass (196th St. SW) to 220th St. SW Overpass**

Quarter	Min.	Max	Median	Avg.	SD	Speed (mph) >90%	Percent >45 mph	Number of Data Points
Q4/95	8	62	55	51	11	40	81.5%	28
Q1/96	17	62	56	55	7	50	97.1%	32
Q2/96	40	63	60	59	5	55	96.6%	30
Q3/96	No Data	No Data	No Data	No Data	No Data	No Data	No Data	No Data
Q4/96	12	67	59	55	11	48	91.3%	21
Q1/97	36	66	55	56	7	46	90.5%	32
Q2/97 & Q3/97	No Data Collected							
Q4/97	10	69	59	56	10	45	94.1%	68
Q1/98	29	69	61	59	6	52	97.1%	68

**NORTH I-5 CORRIDOR, P.M. SOUTHBOUND**

**1) NE 145th St. Overpass to NE 117th St. Overpass**

Quarter	Min.	Max	Median	Avg.	SD	Speed (mph) >90%	Percent >45 mph	Number of Data Points
Q4/95	55	68	61	61	4	57	100.0%	27
Q1/96	39	61	57	57	4	55	98.5%	30
Q2/96	52	64	62	61	2	60	100.0%	30
Q3/96	58	65	62	62	2	59	100.0%	12
Q4/96	44	67	61	59	6	48	95.0%	22
Q1/97	55	64	59	59	2	57	100.0%	24
Q2/97 & Q3/97 No Data Collected								
Q4/97	26	65	62	60	7	55	94.4%	89
Q1/98	49	65	63	61	4	56	100.0%	73

**2) NE 185th St. Overpass to NE 145th St. Overpass**

Quarter	Min.	Max	Median	AVG.	SD	Speed (mph) >90%	Percent >45 mph	Number of Data Points
Q4/95	55	69	61	62	3	58	100.0%	27
Q1/96	56	64	58	59	2	57	100.0%	30
Q2/96	60	64	62	62	1	61	100.0%	30
Q3/96	60	65	62	62	2	60	100.0%	12
Q4/96	53	65	61	61	3	58	100.0%	22
Q1/97	53	63	60	60	2	58	100.0%	24
Q2/97 & Q3/97 No Data Collected								
Q4/97	34	70	63	62	5	58	97.8%	90
Q1/98	42	65	63	62	3	58	98.6%	73

**3) SR 104 Interchange (NE 205th St.) to NE 185th St. Overpass**

Quarter	Min.	Max	Median	AVG.	SD	Speed (mph) >90%	Percent >45 mph	Number of Data Points
Q4/95	44	67	62	61	5	58	99.6%	27
Q1/96	54	61	59	59	2	57	100.0%	30
Q2/96	52	65	62	62	2	59	100.0%	30
Q3/96	59	64	62	62	2	60	100.0%	12
Q4/96	58	68	63	62	3	59	100.0%	23
Q1/97	56	64	61	61	2	59	100.0%	24
Q2/97 & Q3/97 No Data Collected								
Q4/97	27	68	63	62	5	59	97.8%	89
Q1/98	54	66	63	62	3	58	100.0%	73

**NORTH I-5 CORRIDOR, P.M. SOUTHBOUND**

**4) 220th St. Overpass to SR 104 Interchange (NE 205th St.)**

Quarter	Min.	Max	Median	AVG.	SD	Speed (mph) >90%	Percent >45 mph	Number of Data Points
Q4/95	57	71	64	64	4	59	100.0%	26
Q1/96	55	64	60	60	2	58	100.0%	30
Q2/96	60	67	64	64	2	62	100.0%	30
Q3/96	61	67	65	65	2	63	100.0%	11
Q4/96	59	67	64	64	2	61	100.0%	23
Q1/97	58	66	63	63	2	60	100.0%	24
Q2/97 & Q3/97 No Data Collected								
Q4/97	56	71	66	65	3	61	100.0%	88
Q1/98	55	72	66	65	3	62	100.0%	73

**5) SR 524 Overpass (196th St. SW) to 220th St. SW Overpass**

Quarter	Min.	Max	Median	AVG.	SD	Speed (mph) >90%	Percent >45 mph	Number of Data Points
Q4/95	54	64	59	59	3	55	100.0%	26
Q1/96	54	60	57	57	2	55	100.0%	30
Q2/96	58	63	60	60	1	59	100.0%	30
Q3/96	58	63	60	61	2	59	100.0%	11
Q4/96	57	64	60	60	2	58	100.0%	23
Q1/97	53	63	59	59	2	57	100.0%	24
Q2/97 & Q3/97 No Data Collected								
Q4/97	47	68	61	60	4	57	100.0%	88
Q1/98	39	65	61	60	5	58	95.8%	72

**NORTH I-5 CORRIDOR, A.M. NORTHBOUND**

**1) NE 117th St. Overpass to NE 145th St. Overpass**

Quarter	Min.	Max	Median	AVG.	SD	Speed (mph) >90%	Percent >45 mph	Number of Data Points
Q4/95	56	73	61	61	4	57	100.0%	31
Q1/96	50	61	57	57	2	56	100.0%	34
Q2/96	59	65	61	62	1	60	100.0%	30
Q3/96	No Data	No Data	No Data	No Data	No Data	No Data	No Data	No Data
Q4/96	57	63	60	60	2	58	100.0%	22
Q1/97	54	65	59	59	4	55	100.0%	34
Q2/97 & Q3/97	No Data Collected							
Q4/97	57	67	61	61	2	59	100.0%	75
Q1/98	45	69	62	61	4	56	100.0%	70

**2) NE 145th St. Overpass to NE 185th St. Overpass**

Quarter	Min.	Max	Median	AVG.	SD	Speed (mph) >90%	Percent >45 mph	Number of Data Points
Q4/95	55	68	60	61	3	58	100.0%	31
Q1/96	56	63	58	58	2	57	100.0%	34
Q2/96	58	65	62	62	2	60	100.0%	30
Q3/96	No Data	No Data	No Data	No Data	No Data	No Data	No Data	No Data
Q4/96	55	68	61	61	3	58	100.0%	22
Q1/97	54	68	60	60	4	55	100.0%	34
Q2/97 & Q3/97	No Data Collected							
Q4/97	58	68	62	62	2	60	100.0%	75
Q1/98	52	66	63	62	3	57	100.0%	70

**3) NE 185th St. Overpass to SR 104 Interchange (NE 205th St.)**

Quarter	Min.	Max	Median	AVG.	SD	Speed (mph) >90%	Percent >45 mph	Number of Data Points
Q4/95	49	66	62	61	4	56	100.0%	31
Q1/96	54	65	58	58	3	55	100.0%	32
Q2/96	51	64	62	61	3	57	100.0%	30
Q3/96	No Data	No Data	No Data	No Data	No Data	No Data	No Data	No Data
Q4/96	56	65	61	60	2	58	100.0%	20
Q1/97	53	69	61	60	5	55	100.0%	34
Q2/97 & Q3/97	No Data Collected							
Q4/97	56	67	62	62	2	60	100.0%	74
Q1/98	52	67	64	63	3	57	100.0%	70

**NORTH I-5 CORRIDOR, A.M. NORTHBOUND**

**4) SR 104 Interchange (NE 205th St.) to 220th St. Overpass**

Quarter	Min.	Max	Median	AVG.	SD	Speed (mph) >90%	Percent >45 mph	Number of Data Points
Q4/95	34	71	65	63	7	60	97.6%	31
Q1/96	56	68	60	61	3	58	100.0%	32
Q2/96	56	69	65	65	3	63	100.0%	30
Q3/96	No Data	No Data	No Data	No Data	No Data	No Data	No Data	No Data
Q4/96	61	68	64	64	2	62	100.0%	20
Q1/97	51	69	65	63	5	58	100.0%	34
Q2/97 & Q3/97	No Data Collected							
Q4/97	59	70	64	64	2	62	100.0%	74
Q1/98	59	70	66	65	2	61	100.0%	71

**5) 220th St. SW Overpass to SR 524 Overpass (196th St. SW)**

Quarter	Min.	Max	Median	AVG.	SD	Speed (mph) >90%	Percent >45 mph	Number of Data Points
Q4/95	52	68	61	60	3	56	100.0%	31
Q1/96	8	65	56	55	9	54	97.3%	32
Q2/96	53	64	60	61	2	59	100.0%	30
Q3/96	No Data	No Data	No Data	No Data	No Data	No Data	No Data	No Data
Q4/96	57	62	59	59	1	58	100.0%	20
Q1/97	47	64	59	58	5	54	100.0%	34
Q2/97 & Q3/97	No Data Collected							
Q4/97	48	64	60	60	3	57	100.0%	74
Q1/98	54	67	62	61	2	58	100.0%	71

**NORTH I-5 CORRIDOR, P.M. NORTHBOUND**

**1) NE 117th St. Overpass to NE 145th St. Overpass**

Quarter	Min.	Max	Median	AVG.	SD	Speed (mph) >90%	Percent >45 mph	Number of Data Points
Q4/95	39	70	59	58	7	49	92.4%	27
Q1/96	33	62	57	54	8	39	83.6%	34
Q2/96	16	64	60	52	15	24	77.1%	30
Q3/96	No Data	No Data	No Data	No Data	No Data	No Data	No Data	No Data
Q4/96	32	62	54	54	8	45	90.0%	23
Q1/97	55	64	59	59	2	56	100.0%	24
Q2/97 & Q3/97	No Data Collected							
Q4/97	13	71	59	54	12	33	81.1%	90
Q1/98	21	64	60	54	12	30	83.8%	74

**2) NE 145th St. Overpass to NE 185th St. Overpass**

Quarter	Min.	Max	Median	AVG.	SD	Speed (mph) >90%	Percent >45 mph	Number of Data Points
Q4/95	29	64	53	49	11	35	60.9%	27
Q1/96	14	62	56	49	13	29	72.5%	33
Q2/96	14	64	48	44	16	20	58.7%	30
Q3/96	No Data	No Data	No Data	No Data	No Data	No Data	No Data	No Data
Q4/96	35	63	58	55	8	44	88.2%	24
Q1/97	57	65	59	59	2	57	100.0%	24
Q2/97 & Q3/97	No Data Collected							
Q4/97	31	69	58	55	9	40	78.0%	91
Q1/98	30	68	61	56	10	36	82.4%	74

**3) NE 185th St. Overpass to SR 104 Interchange (NE 205th St.)**

Quarter	Min.	Max	Median	AVG.	SD	Speed (mph) >90%	Percent >45 mph	Number of Data Points
Q4/95	12	62	21	29	16	16	21.5%	27
Q1/96	5	60	31	33	17	15	25.0%	33
Q2/96	15	67	24	29	14	17	12.8%	30
Q3/96	No Data	No Data	No Data	No Data	No Data	No Data	No Data	No Data
Q4/96	42	66	60	57	6	50	98.2%	24
Q1/97	57	67	60	60	2	58	100.0%	24
Q2/97 & Q3/97	No Data Collected							
Q4/97	34	67	61	59	6	50	96.7%	92
Q1/98	45	67	62	60	6	52	100.0%	74



**NORTH I-5 CORRIDOR, P.M. NORTHBOUND**

**4) SR 104 Interchange (NE 205th St.) to 220th St. Overpass**

Quarter	Min.	Max	Median	AVG.	SD	Speed (mph) >90%	Percent >45 mph	Number of Data Points
Q4/95	18	63	30	33	13	23	15.1%	27
Q1/96	18	65	29	37	16	22	26.6%	33
Q2/96	20	64	34	36	11	23	15.6%	30
Q3/96	No Data	No Data	No Data	No Data	No Data	No Data	No Data	No Data
Q4/96	58	69	63	63	3	60	100.0%	24
Q1/97	51	66	63	63	3	61	100.0%	24
Q2/97 & Q3/97	No Data Collected							
Q4/97	48	69	65	63	4	57	100.0%	91
Q1/98	47	68	65	63	4	58	100.0%	74

**5) 220th St. SW Overpass to SR 524 Overpass (196th St. SW)**

Quarter	Min.	Max	Median	AVG.	SD	Speed (mph) >90%	Percent >45 mph	Number of Data Points
Q4/95	17	59	44	45	7	39	46.2%	27
Q1/96	16	60	46	46	10	36	54.6%	34
Q2/96	39	59	46	47	6	41	72.5%	30
Q3/96	No Data	No Data	No Data	No Data	No Data	No Data	No Data	No Data
Q4/96	56	64	59	59	2	57	100.0%	24
Q1/97	17	63	59	57	9	54	96.4%	24
Q2/97 & Q3/97	No Data Collected							
Q4/97	37	67	61	59	6	53	95.6%	90
Q1/98	46	64	60	60	3	55	100.0%	72

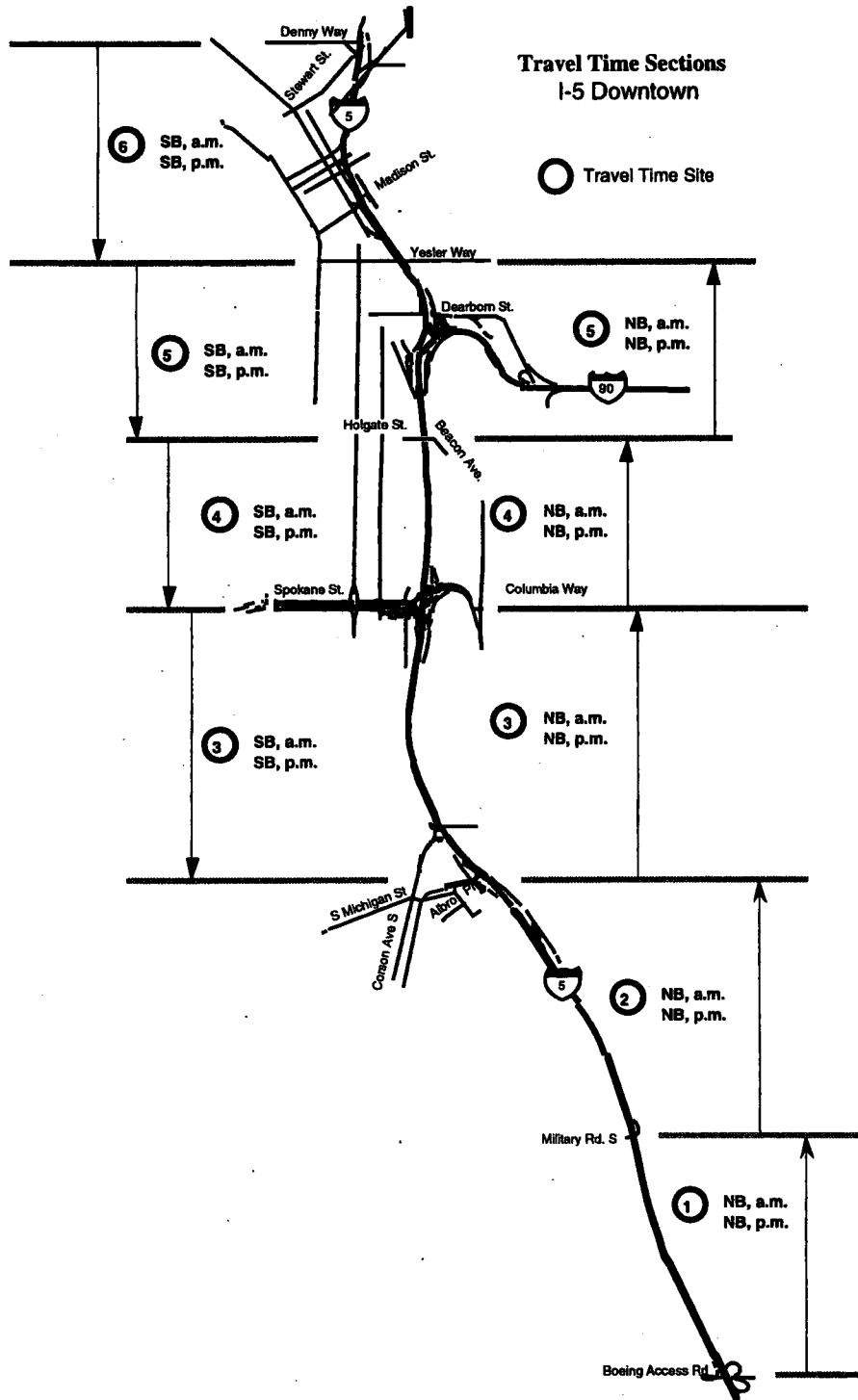

**DOWNTOWN I-5 CORRIDOR, A.M. SOUTHBOUND**

**3) Spokane St./Columbia Way Off-Ramp to Albro Place Overpass**

Quarter	Min.	Max	Median	AVG.	SD	Speed (mph) >90%	Percent >45 mph	Number of Data Points
Q4/95	55	66	62	61	3	57	100.0%	12
Q1/96	53	68	60	60	4	56	100.0%	17
Q2/96	57	66	62	62	2	60	100.0%	12
Q3/96	No Data	No Data	No Data	No Data	No Data	No Data	No Data	No Data
Q4/96	55	63	59	59	3	56	100.0%	5
Q1/97	58	66	62	61	3	59	100.0%	9
Q2/97 & Q3/97	No Data Collected							
Q4/97	54	68	62	62	3	59	100.0%	34
Q1/98	56	68	64	64	3	61	100.0%	35

**4) Holgate St./Beacon Ave. Overpass to Spokane St./Columbia Way Off-Ramp**

Quarter	Min.	Max	Median	Avg.	SD	Speed (mph) >90%	Percent >45 mph	Number of Data Points
Q4/95	49	63	58	57	4	52	100.0%	13
Q1/96	49	65	58	58	4	54	100.0%	17
Q2/96	41	63	60	59	5	58	100.0%	12
Q3/96	No Data	No Data	No Data	No Data	No Data	No Data	No Data	No Data
Q4/96	45	63	60	57	6	49	100.0%	6
Q1/97	39	63	57	54	9	39	81.0%	9
Q2/97 & Q3/97	No Data Collected							
Q4/97	51	65	61	61	3	57	100.0%	38
Q1/98	52	69	62	61	4	55	100.0%	33

**5) Yesler Way Overpass to Holgate St./Beacon Ave. Overpass**

Quarter	Min.	Max	Median	AVG.	SD	Speed (mph) >90%	Percent >45 mph	Number of Data Points
Q4/95	44	64	59	58	5	55	100.0%	14
Q1/96	44	65	59	60	5	57	100.0%	19
Q2/96	59	63	61	61	1	59	100.0%	12
Q3/96	No Data	No Data	No Data	No Data	No Data	No Data	No Data	No Data
Q4/96	55	61	57	58	2	55	100.0%	6
Q1/97	38	64	60	57	8	45	89.3%	9
Q2/97 & Q3/97	No Data Collected							
Q4/97	35	65	60	57	8	41	89.5%	38
Q1/98	40	63	57	56	5	47	93.9%	33

**DOWNTOWN I-5 CORRIDOR, A.M. SOUTHBOUND**

**6) Denny Way Overpass to Yesler Way Overpass**

Quarter	Min.	Max	Median	AVG.	SD	Speed (mph) >90%	Percent >45 mph	Number of Data Points
Q4/95	55	69	60	61	4	55	100.0%	13
Q1/96	56	70	59	60	4	57	99.6%	19
Q2/96	59	63	60	61	1	59	100.0%	12
Q3/96	No Data	No Data	No Data	No Data	No Data	No Data	No Data	No Data
Q4/96	47	61	59	57	5	49	100.0%	7
Q1/97	36	61	60	53	10	37	75.6%	9
Q2/97 & Q3/97	No Data Collected							
Q4/97	39	67	60	57	7	42	86.8%	38
Q1/98	32	67	60	58	8	45	91.2%	34

**DOWNTOWN I-5 CORRIDOR, P.M. SOUTHBOUND**

**3) Spokane St./Columbia Way Off-Ramp to Albro Place Overpass**

Quarter	Min.	Max	Median	AVG.	SD	Speed (mph) >90%	Percent >45 mph	Number of Data Points
Q4/95	52	61	60	59	3	56	100.0%	11
Q1/96	15	62	56	52	11	51	84.9%	13
Q2/96	37	66	61	58	7	52	86.7%	12
Q3/96	No Data	No Data	No Data	No Data	No Data	No Data	No Data	No Data
Q4/96	38	55	43	45	6	39	37.8%	4
Q1/97	52	64	60	59	4	54	100.0%	5
Q2/97 & Q3/97	No Data Collected							
Q4/97	57	67	64	63	3	60	100.0%	34
Q1/98	53	68	64	64	3	60	100.0%	32

**4) Holgate St./Beacon Ave. Overpass to Spokane St./Columbia Way Off-Ramp**

Quarter	Min.	Max	Median	AVG.	SD	Speed (mph) >90%	Percent >45 mph	Number of Data Points
Q4/95	52	65	61	60	4	57	100.0%	11
Q1/96	23	60	55	51	12	31	84.9%	13
Q2/96	25	63	58	54	11	39	86.7%	12
Q3/96	No Data	No Data	No Data	No Data	No Data	No Data	No Data	No Data
Q4/96	50	55	53	53	2	50	100.0%	4
Q1/97	46	58	55	54	4	50	100.0%	5
Q2/97 & Q3/97	No Data Collected							
Q4/97	54	67	62	62	3	57	100.0%	44
Q1/98	23	65	62	59	8	52	93.8%	32

**5) Yesler Way Overpass to Holgate St./Beacon Ave. Overpass**

Quarter	Min.	Max	Median	AVG.	SD	Speed (mph) >90%	Percent >45 mph	Number of Data Points
Q4/95	41	64	60	57	6	52	96.4%	11
Q1/96	36	63	59	57	7	49	93.8%	12
Q2/96	33	66	62	59	8	55	95.1%	12
Q3/96	No Data	No Data	No Data	No Data	No Data	No Data	No Data	No Data
Q4/96	55	59	57	57	1	56	100.0%	4
Q1/97	50	62	61	58	5	53	100.0%	5
Q2/97 & Q3/97	No Data Collected							
Q4/97	44	71	58	57	5	49	93.2%	44
Q1/98	43	63	58	57	5	48	96.9%	32

**DOWNTOWN I-5 CORRIDOR, P.M. SOUTHBOUND**

**6) Denny Way Overpass to Yesler Way Overpass**

Quarter	Min.	Max	Median	AVG.	SD	Speed (mph) >90%	Percent >45 mph	Number of Data Points
Q4/95	52	71	59	59	5	53	100.0%	11
Q1/96	42	62	58	56	6	45	89.8%	12
Q2/96	49	63	60	58	4	54	100.0%	12
Q3/96	No Data	No Data	No Data	No Data	No Data	No Data	No Data	No Data
Q4/96	52	61	58	57	4	53	100.0%	4
Q1/97	47	58	53	53	4	48	100.0%	5
Q2/97 & Q3/97	No Data Collected							
Q4/97	45	66	62	60	4	53	100.0%	44
Q1/98	51	67	62	61	3	57	100.0%	33

**DOWNTOWN I-5 CORRIDOR, A.M. NORTHBOUND**

**1) S 107th St. (Boeing Access Rd.) Overpass to Military Rd. S Underpass**

Quarter	Min.	Max	Median	AVG.	SD	Speed (mph) >90%	Percent >45 mph	Number of Data Points
Q4/95	59	64	61	61	2	60	100.0%	10
Q1/96	56	66	63	62	4	57	100.0%	10
Q2/96	60	65	62	62	1	60	100.0%	15
Q3/96	No Data	No Data	No Data	No Data	No Data	No Data	No Data	No Data
Q4/96	60	69	62	62	3	60	100.0%	7
Q1/97	44	66	59	58	6	54	99.3%	11
Q2/97 & Q3/97	No Data Collected							
Q4/97	33	67	61	58	8	45	91.9%	37
Q1/98	22	65	61	57	10	37	86.1%	36

**2) Military Rd. S Underpass to Albro Place Overpass**

Quarter	Min.	Max	Median	AVG.	SD	Speed (mph) >90%	Percent >45 mph	Number of Data Points
Q4/95	60	63	62	62	1	60	100.0%	10
Q1/96	58	65	63	62	2	59	100.0%	10
Q2/96	52	65	62	62	3	59	100.0%	16
Q3/96	No Data	No Data	No Data	No Data	No Data	No Data	No Data	No Data
Q4/96	54	67	62	61	4	57	100.0%	7
Q1/97	37	65	59	55	9	39	84.1%	11
Q2/97 & Q3/97	No Data Collected							
Q4/97	30	68	62	60	7	53	97.4%	38
Q1/98	25	66	62	56	12	31	82.9%	35

**3) Albro Place Overpass to Spokane St./Columbia Way Off-Ramp**

Quarter	Min.	Max	Median	AVG.	SD	Speed (mph) >90%	Percent >45 mph	Number of Data Points
Q4/95	55	63	59	59	3	56	100.0%	10
Q1/96	48	63	58	57	4	53	100.0%	10
Q2/96	53	64	59	59	3	55	100.0%	16
Q3/96	No Data	No Data	No Data	No Data	No Data	No Data	No Data	No Data
Q4/96	28	64	56	52	11	41	86.5%	7
Q1/97	42	62	56	55	6	48	94.5%	11
Q2/97 & Q3/97	No Data Collected							
Q4/97	20	69	60	56	10	44	91.9%	37
Q1/98	21	67	58	52	13	28	79.4%	34

**DOWNTOWN I-5 CORRIDOR, A.M. NORTHBOUND**

**4) Spokane St./Columbia Way Off-Ramp to Holgate St./Beacon Ave. Overpass**

Quarter	Min.	Max	Median	AVG.	SD	Speed (mph) >90%	Percent >45 mph	Number of Data Points
Q4/95	60	66	63	63	2	60	100.0%	10
Q1/96	54	68	64	63	5	55	100.0%	10
Q2/96	53	67	64	63	4	56	100.0%	15
Q3/96	No Data	No Data	No Data	No Data	No Data	No Data	No Data	No Data
Q4/96	32	65	57	54	11	39	82.3%	7
Q1/97	44	68	59	58	7	49	98.5%	11
Q2/97 & Q3/97	No Data Collected							
Q4/97	34	61	53	50	9	35	70.3%	37
Q1/98	33	65	48	49	9	37	62.9%	35

**5) Holgate St./Beacon Ave. Overpass to Yesler Way Overpass**

Quarter	Min.	Max	Median	AVG.	SD	Speed (mph) >90%	Percent >45 mph	Number of Data Points
Q4/95	30	59	56	54	8	50	92.5%	10
Q1/96	29	65	59	54	11	41	76.9%	10
Q2/96	24	64	58	53	10	42	83.7%	15
Q3/96	No Data	No Data	No Data	No Data	No Data	No Data	No Data	No Data
Q4/96	16	59	56	43	17	19	60.1%	7
Q1/97	15	67	31	39	17	16	37.4%	11
Q2/97 & Q3/97	No Data Collected							
Q4/97	31	68	57	56	9	44	89.2%	37
Q1/98	45	67	56	56	6	47	97.1%	35



**DOWNTOWN I-5 CORRIDOR, P.M. NORTHBOUND**

**1) S 107th St. (Boeing Access Rd.) Overpass to Military Rd. S Underpass**

Quarter	Min.	Max	Median	AVG.	SD	Speed (mph) >90%	Percent >45 mph	Number of Data Points
Q4/95	59	68	63	62	2	60	100.0%	10
Q1/96	44	62	62	59	6	53	99.0%	8
Q2/96	60	66	63	63	2	60	100.0%	12
Q3/96	No Data	No Data	No Data	No Data	No Data	No Data	No Data	No Data
Q4/96	50	64	61	59	5	53	100.0%	5
Q1/97	55	66	63	61	4	56	100.0%	6
Q2/97 & Q3/97	No Data Collected							
Q4/97	55	65	62	61	3	56	81.1%	49
Q1/98	55	66	63	62	2	58	100.0%	34

**2) Military Rd. S Underpass to Albro Place Overpass**

Quarter	Min.	Max	Median	AVG.	SD	Speed (mph) >90%	Percent >45 mph	Number of Data Points
Q4/95	53	68	62	62	4	57	100.0%	10
Q1/96	34	63	60	55	10	40	83.7%	8
Q2/96	58	66	63	62	2	58	100.0%	12
Q3/96	No Data	No Data	No Data	No Data	No Data	No Data	No Data	No Data
Q4/96	51	64	55	58	5	53	100.0%	5
Q1/97	55	64	62	61	3	56	100.0%	6
Q2/97 & Q3/97	No Data Collected							
Q4/97	38	68	62	61	6	53	78.0%	49
Q1/98	55	66	63	63	2	60	100.0%	34

**3) Albro Place Overpass to Spokane St./Columbia Way Off-Ramp**

Quarter	Min.	Max	Median	AVG.	SD	Speed (mph) >90%	Percent >45 mph	Number of Data Points
Q4/95	48	64	56	56	6	50	100.0%	10
Q1/96	16	62	45	41	18	17	50.0%	8
Q2/96	50	66	61	61	4	56	100.0%	12
Q3/96	No Data	No Data	No Data	No Data	No Data	No Data	No Data	No Data
Q4/96	42	56	48	49	6	42	62.5%	5
Q1/97	50	62	56	56	4	51	100.0%	6
Q2/97 & Q3/97	No Data Collected							
Q4/97	22	66	60	56	10	42	96.7%	52
Q1/98	55	67	63	62	3	57	100.0%	32

**DOWNTOWN I-5 CORRIDOR, P.M. NORTHBOUND**

**4) Spokane St./Columbia Way Off-Ramp to Holgate St./Beacon Ave. Overpass**

Quarter	Min.	Max	Median	AVG.	SD	Speed (mph) >90%	Percent >45 mph	Number of Data Points
Q4/95	33	61	54	51	8	40	77.8%	10
Q1/96	11	67	60	55	17	40	88.5%	8
Q2/96	58	66	63	63	2	60	100.0%	12
Q3/96	No Data	No Data	No Data	No Data	No Data	No Data	No Data	No Data
Q4/96	45	65	48	51	7	46	100.0%	5
Q1/97	58	69	62	63	4	59	100.0%	6
Q2/97 & Q3/97	No Data Collected							
Q4/97	18	68	53	50	12	29	100.0%	52
Q1/98	35	62	59	57	6	47	90.6%	32

**5) Holgate St./Beacon Ave. Overpass to Yesler Way Overpass**

Quarter	Min.	Max	Median	AVG.	SD	Speed (mph) >90%	Percent >45 mph	Number of Data Points
Q4/95	10	55	26	29	12	18	8.6%	10
Q1/96	9	65	55	49	16	33	82.2%	8
Q2/96	23	65	57	55	11	53	92.7%	11
Q3/96	No Data	No Data	No Data	No Data	No Data	No Data	No Data	No Data
Q4/96	34	57	40	43	9	35	26.5%	4
Q1/97	12	59	44	41	17	21	48.6%	6
Q2/97 & Q3/97	No Data Collected							
Q4/97	6	70	49.5	48	16	25	95.6%	50
Q1/98	38	68	63	60	9	41	87.5%	32

**Travel Time Sections  
I-5 South**

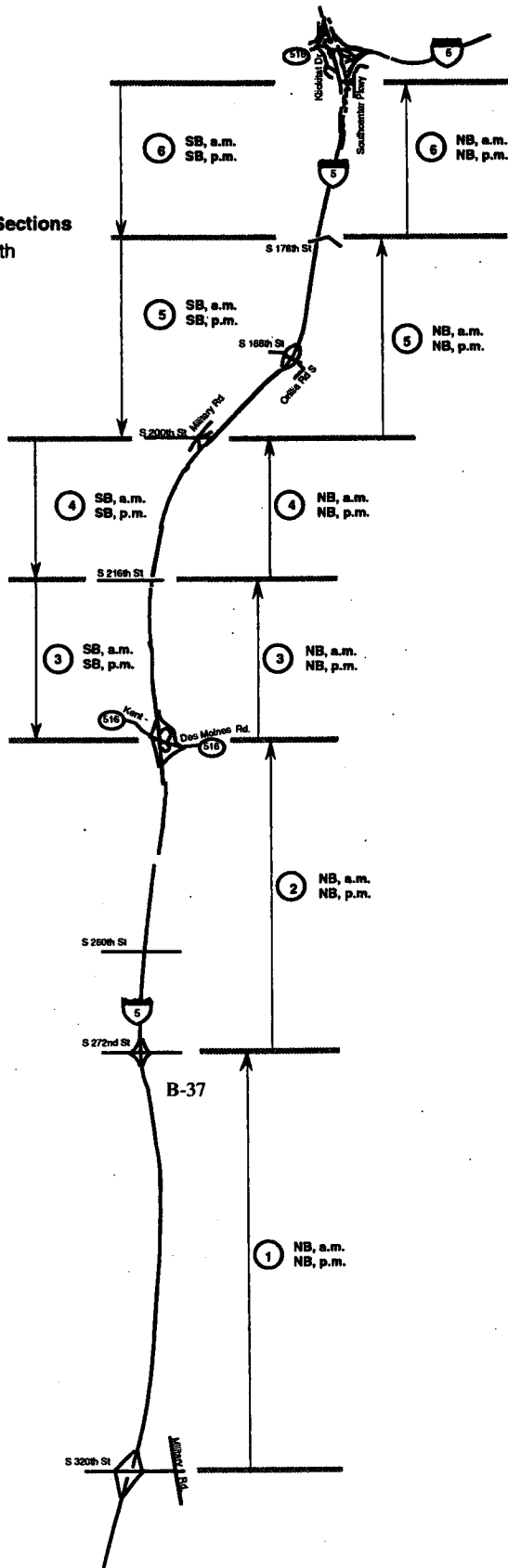

**SOUTH I-5 CORRIDOR, A.M. SOUTHBOUND**

**3) S 216th St. Overpass to SR 516 Underpass (Kent-Des Moines Rd.)**

Quarter	Min.	Max	Median	AVG.	SD	Speed (mph) >90%	Percent >45 mph	Number of Data Points
Q4/95	56	68	62	62	3	56	100.0%	25
Q1/96	44	66	60	59	4	56	99.8%	40
Q2/96	19	68	62	62	7	60	98.4%	42
Q3/96	No Data	No Data	No Data	No Data	No Data	No Data	No Data	No Data
Q4/96	32	66	61	60	6	57	97.7%	28
Q1/97	54	66	61	61	4	56	100.0%	26
Q2/97 & Q3/97	No Data Collected							
Q4/97	38	69	61	61	4	60	98.2%	56
Q1/98	57	69	62	62	2	60	100.0%	61

**4) Military Rd. S (S 200th St.) Overpass to S 216th St. Overpass**

Quarter	Min.	Max	Median	AVG.	SD	Speed (mph) >90%	Percent >45 mph	Number of Data Points
Q4/95	55	71	60	61	3	57	100.0%	25
Q1/96	55	62	59	59	2	57	100.0%	40
Q2/96	58	65	61	61	2	59	100.0%	42
Q3/96	No Data	No Data	No Data	No Data	No Data	No Data	No Data	No Data
Q4/96	47	67	59	59	3	58	100.0%	28
Q1/97	54	65	60	59	3	54	100.0%	26
Q2/97 & Q3/97	No Data Collected							
Q4/97	55	70	60	60	2	58	100.0%	56
Q1/98	46	70	61	61	3	58	100.0%	61

**5) S 178th St. Overpass to Military Rd. S (S 200th St.) Overpass**

Quarter	Min.	Max	Median	AVG.	SD	Speed (mph) >90%	Percent >45 mph	Number of Data Points
Q4/95	55	72	63	63	4	58	100.0%	25
Q1/96	58	68	61	62	3	59	100.0%	39
Q2/96	60	68	64	63	2	61	100.0%	42
Q3/96	No Data	No Data	No Data	No Data	No Data	No Data	No Data	No Data
Q4/96	59	65	61	61	1	60	100.0%	22
Q1/97	55	68	62	62	4	56	100.0%	25
Q2/97 & Q3/97	No Data Collected							
Q4/97	53	68	62	62	3	59	100.0%	55
Q1/98	60	69	63	64	2	61	100.0%	61

**SOUTH I-5 CORRIDOR, A.M. SOUTHBOUND**

**6) Klickitat Drive Underpass to S 178th St. Overpass**

Quarter	Min.	Max	Median	AVG.	SD	Speed (mph) >90%	Percent >45 mph	Number of Data Points
Q4/95	49	71	62	62	5	55	100.0%	23
Q1/96	54	66	61	61	3	57	100.0%	40
Q2/96	57	66	63	63	2	60	100.0%	42
Q3/96	No Data	No Data	No Data	No Data	No Data	No Data	No Data	No Data
Q4/96	58	66	61	61	2	59	100.0%	21
Q1/97	55	69	61	61	3	57	100.0%	24
Q2/97 & Q3/97	No Data Collected							
Q4/97	13	70	61	59	8	52	96.4%	55
Q1/98	54	70	63	62	3	58	100.0%	59

**SOUTH I-5 CORRIDOR, P.M. SOUTHBOUND**

**3) S 216th St. Overpass to SR 516 Underpass (Kent-Des Moines Rd.)**

Quarter	Min.	Max	Median	AVG.	SD	Speed (mph) >90%	Percent >45 mph	Number of Data Points
Q4/95	29	75	57	55	9	44	87.1%	32
Q1/96	26	63	46	45	13	29	50.6%	31
Q2/96	26	67	60	55	11	44	86.7%	31
Q3/96	No Data	No Data	No Data	No Data	No Data	No Data	No Data	No Data
Q4/96	23	62	56	49	15	25	68.7%	16
Q1/97	20	66	51	48	13	28	62.9%	24
Q2/97 & Q3/97	No Data Collected							
Q4/97	21	67	46	44	16	23	50.8%	61
Q1/98	14	67	34	41	18	21	37.9%	58

**4) Military Rd. S (S 200th St.) Overpass to S 216th St. Overpass**

Quarter	Min.	Max	Median	AVG.	SD	Speed (mph) >90%	Percent >45 mph	Number of Data Points
Q4/95	28	65	54	51	9	38	74.2%	32
Q1/96	22	62	47	47	11	31	61.7%	31
Q2/96	21	65	59	55	10	47	90.6%	31
Q3/96	No Data	No Data	No Data	No Data	No Data	No Data	No Data	No Data
Q4/96	11	65	54	47	16	22	69.6%	16
Q1/97	15	64	51	47	14	28	62.7%	24
Q2/97 & Q3/97	No Data Collected							
Q4/97	13	64	42	43	15	22	46.8%	62
Q1/98	23	64	39	42	14	24	41.4%	58

**5) S 178th St. Overpass to Military Rd. S (S 200th St.) Overpass**

Quarter	Min.	Max	Median	AVG.	SD	Speed (mph) >90%	Percent >45 mph	Number of Data Points
Q4/95	14	66	59	53	13	34	78.9%	32
Q1/96	19	64	57	51	12	36	76.7%	31
Q2/96	20	64	61	57	10	51	93.8%	31
Q3/96	No Data	No Data	No Data	No Data	No Data	No Data	No Data	No Data
Q4/96	18	63	56	51	14	25	82.5%	16
Q1/97	21	62	58	52	11	35	76.6%	24
Q2/97 & Q3/97	No Data Collected							
Q4/97	13	65	49	45	16	19	52.4%	63
Q1/98	16	66	36	42	17	20	44.8%	58

**SOUTH I-5 CORRIDOR, P.M. SOUTHBOUND**

**6) Klickitat Drive Underpass to S 178th St. Overpass**

Quarter	Min.	Max	Median	AVG.	SD	Speed (mph) >90%	Percent >45 mph	Number of Data Points	
Q4/95	42	65	57	56	7	45	96.8%	32	
Q1/96	31	71	51	52	10	39	72.5%	31	
Q2/96	42	65	59	56	7	48	97.5%	31	
Q3/96	No Data	No Data	No Data	No Data	No Data	No Data	No Data	No Data	
Q4/96	16	60	39	38	14	22	30.4%	17	
Q1/97	38	61	49	49	6	43	77.4%	24	
Q2/97 & Q3/97	No Data Collected								
Q4/97	19	67	50	50	11	32	74.6%	63	
Q1/98	13	70	48	44	18	16	56.9%	58	

**SOUTH I-5 CORRIDOR, A.M. NORTHBOUND**

**1) Military Rd. S (S 320th St.) Underpass to S 272nd St. Underpass**

Quarter	Min.	Max	Median	AVG.	SD	Speed (mph) >90%	Percent >45 mph	Number of Data Points
Q4/95	49	74	66	65	7	57	100.0%	25
Q1/96	53	69	59	60	4	54	100.0%	38
Q2/96	51	68	63	63	3	61	100.0%	35
Q3/96	No Data	No Data	No Data	No Data	No Data	No Data	No Data	No Data
Q4/96	45	68	61	59	4	53	100.0%	28
Q1/97	24	68	60	58	10	49	93.8%	26
Q2/97 & Q3/97	No Data Collected							
Q4/97	46	69	61	61	4	53	100.0%	55
Q1/98	34	66	62	60	6	52	98.4%	61

**2) S 272nd St. Underpass to SR 516 Underpass (Kent - Des Moines Rd)**

Quarter	Min.	Max	Median	AVG.	SD	Speed (mph) >90%	Percent >45 mph	Number of Data Points
Q4/95	33	72	57	57	8	50	93.6%	25
Q1/96	24	68	60	58	8	53	95.8%	38
Q2/96	54	66	62	62	2	59	100.0%	35
Q3/96	No Data	No Data	No Data	No Data	No Data	No Data	No Data	No Data
Q4/96	40	66	60	58	6	49	97.9%	28
Q1/97	36	67	59	57	9	44	87.5%	26
Q2/97 & Q3/97	No Data Collected							
Q4/97	36	65	62	57	8	44	86.8%	53
Q1/98	28	66	61	56	10	40	83.1%	59

**3) SR 516 Underpass (Kent - Des Moines Rd.) to S 216th St. Overpass**

Quarter	Min.	Max	Median	AVG.	SD	Speed (mph) >90%	Percent >45 mph	Number of Data Points
Q4/95	48	68	60	60	5	53	100.0%	24
Q1/96	43	67	58	57	5	52	97.3%	38
Q2/96	47	65	61	60	3	56	100.0%	34
Q3/96	No Data	No Data	No Data	No Data	No Data	No Data	No Data	No Data
Q4/96	26	62	57	55	8	44	88.1%	28
Q1/97	44	64	59	57	7	47	96.9%	26
Q2/97 & Q3/97	No Data Collected							
Q4/97	28	64	60	54	10	38	81.1%	53
Q1/98	21	66	60	55	10	40	84.5%	58



**SOUTH I-5 CORRIDOR, A.M. NORTHBOUND**

**4) S 216th St. Overpass to Military Rd. S (S 200th St.) Overpass**

Quarter	Min.	Max	Median	AVG.	SD	Speed (mph) >90%	Percent >45 mph	Number of Data Points
Q4/95	53	73	61	60	6	55	100.0%	24
Q1/96	41	67	58	58	5	55	98.7%	38
Q2/96	49	65	61	61	3	57	100.0%	34
Q3/96	No Data	No Data	No Data	No Data	No Data	No Data	No Data	No Data
Q4/96	41	65	61	59	5	50	98.2%	28
Q1/97	32	67	59	56	8	46	92.0%	26
Q2/97 & Q3/97	No Data Collected							
Q4/97	36	67	60	56	8	43	88.7%	53
Q1/98	33	65	59	56	8	42	87.9%	58

**5) Military Rd. S (S 200th St.) Overpass to S 178th St. Overpass**

Quarter	Min.	Max	Median	AVG.	SD	Speed (mph) >90%	Percent >45 mph	Number of Data Points
Q4/95	54	72	62	62	4	58	100.0%	24
Q1/96	42	65	60	59	5	55	98.4%	38
Q2/96	46	66	63	62	4	57	100.0%	34
Q3/96	No Data	No Data	No Data	No Data	No Data	No Data	No Data	No Data
Q4/96	45	63	59	58	5	52	98.6%	28
Q1/97	47	67	60	58	6	50	100.0%	26
Q2/97 & Q3/97	No Data Collected							
Q4/97	44	66	61	58	6	48	96.2%	53
Q1/98	38	68	60	57	8	44	88.3%	60

**6) S 178th St. Overpass to Klickitat Drive Overpass**

Quarter	Min.	Max	Median	AVG.	SD	Speed (mph) >90%	Percent >45 mph	Number of Data Points
Q4/95	48	74	60	61	5	57	100.0%	24
Q1/96	47	68	61	59	4	54	100.0%	38
Q2/96	30	67	62	60	8	51	94.2%	34
Q3/96	No Data	No Data	No Data	No Data	No Data	No Data	No Data	No Data
Q4/96	12	67	60	57	10	51	96.5%	28
Q1/97	40	67	59	57	7	46	90.8%	26
Q2/97 & Q3/97	No Data Collected							
Q4/97	22	71	61	56	11	38	87.3%	55
Q1/98	42	68	59	58	7	46	93.4%	61

**SOUTH I-5 CORRIDOR, P.M. NORTHBOUND**

**1) Military Rd. S (S 320th St.) Underpass to S 272nd St. Underpass**

Quarter	Min.	Max	Median	AVG.	SD	Speed (mph) >90%	Percent >45 mph	Number of Data Points
Q4/95	48	71	62	62	4	58	100.0%	30
Q1/96	57	68	63	63	3	59	100.0%	30
Q2/96	60	65	62	63	1	61	100.0%	27
Q3/96	No Data	No Data	No Data	No Data	No Data	No Data	No Data	No Data
Q4/96	59	68	61	62	3	60	100.0%	16
Q1/97	57	68	64	63	3	60	100.0%	25
Q2/97 & Q3/97	No Data Collected							
Q4/97	60	66	63	63	2	61	100.0%	57
Q1/98	60	66	64	64	1	62	100.0%	58

**2) S 272nd St. Underpass to SR 516 Underpass (Kent - Des Moines Rd)**

Quarter	Min.	Max	Median	AVG.	SD	Speed (mph) >90%	Percent >45 mph	Number of Data Points
Q4/95	56	71	63	63	4	58	100.0%	30
Q1/96	57	66	62	62	2	59	100.0%	30
Q2/96	60	66	62	63	2	61	100.0%	29
Q3/96	No Data	No Data	No Data	No Data	No Data	No Data	No Data	No Data
Q4/96	60	75	62	64	4	60	100.0%	16
Q1/97	57	66	63	62	3	58	100.0%	25
Q2/97 & Q3/97	No Data Collected							
Q4/97	57	67	63	63	2	61	100.0%	57
Q1/98	57	67	64	64	2	61	100.0%	58

**3) SR 516 Underpass (Kent - Des Moines Rd.) to S 216th St. Overpass**

Quarter	Min.	Max	Median	AVG.	SD	Speed (mph) >90%	Percent >45 mph	Number of Data Points
Q4/95	38	66	61	60	5	58	98.6%	30
Q1/96	56	65	61	61	2	58	100.0%	30
Q2/96	59	66	61	62	2	60	100.0%	28
Q3/96	No Data	No Data	No Data	No Data	No Data	No Data	No Data	No Data
Q4/96	58	71	61	63	4	59	100.0%	16
Q1/97	54	65	61	61	3	57	100.0%	25
Q2/97 & Q3/97	No Data Collected							
Q4/97	54	67	61	61	3	57	100.0%	56
Q1/98	57	67	63	63	2	60	100.0%	58

**SOUTH I-5 CORRIDOR, P.M. NORTHBOUND**

**4) S 216th St. Overpass to Military Rd. S (S 200th St.) Overpass**

Quarter	Min.	Max	Median	AVG.	SD	Speed (mph) >90%	Percent >45 mph	Number of Data Points
Q4/95	55	73	62	62	4	58	100.0%	30
Q1/96	57	67	60	61	2	57	100.0%	30
Q2/96	58	65	62	62	2	60	100.0%	28
Q3/96	No Data	No Data	No Data	No Data	No Data	No Data	No Data	No Data
Q4/96	57	68	61	62	3	59	100.0%	16
Q1/97	55	67	61	61	3	56	100.0%	24
Q2/97 & Q3/97	No Data Collected							
Q4/97	57	68	62	62	2	60	100.0%	56
Q1/98	59	70	64	64	2	61	100.0%	58

**5) Military Rd. S (S 200th St.) Overpass to S 178th St. Overpass**

Quarter	Min.	Max	Median	AVG.	SD	Speed (mph) >90%	Percent >45 mph	Number of Data Points
Q4/95	55	71	62	62	3	59	100.0%	30
Q1/96	56	67	62	62	3	57	100.0%	30
Q2/96	61	66	63	63	1	61	100.0%	28
Q3/96	No Data	No Data	No Data	No Data	No Data	No Data	No Data	No Data
Q4/96	60	67	62	63	3	60	100.0%	16
Q1/97	55	69	62	62	4	58	100.0%	24
Q2/97 & Q3/97	No Data Collected							
Q4/97	37	70	63	63	4	62	98.2%	57
Q1/98	58	69	64	64	2	62	100.0%	58

**6) S 178th St. Overpass to Klickitat Drive Overpass**

Quarter	Min.	Max	Median	AVG.	SD	Speed (mph) >90%	Percent >45 mph	Number of Data Points
Q4/95	57	75	63	64	4	59	100.0%	30
Q1/96	33	67	61	59	7	51	94.9%	30
Q2/96	56	65	64	63	2	61	100.0%	28
Q3/96	No Data	No Data	No Data	No Data	No Data	No Data	No Data	No Data
Q4/96	32	71	61	59	8	53	95.9%	16
Q1/97	51	65	60	61	3	58	100.0%	24
Q2/97 & Q3/97	No Data Collected							
Q4/97	30	68	63	62	5	60	98.3%	58
Q1/98	39	68	64	63	4	61	98.3%	58

# Travel Time Sections SR 520 (Corridor #4)

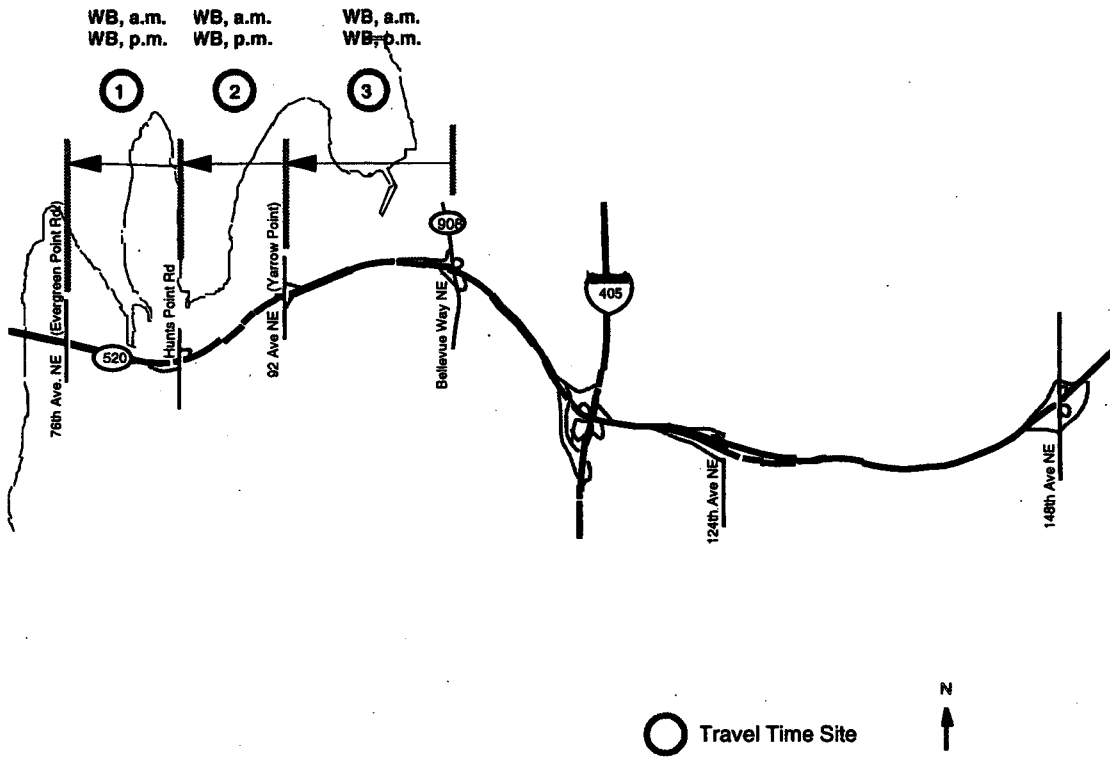

**SR 520 CORRIDOR, A.M. WESTBOUND**

**1) Pedestrian Overpass at Hunts Point to 76th Ave. NE (Evergreen Point Rd.)**

Quarter	Min.	Max	Median	AVG.	SD	Speed (mph) >90%	Percent >45 mph	Number of Data Points
Q4/95	21	51	34	33	10	22	9.6%	8
Q1/96	19	55	41	40	12	22	33.4%	10
Q2/96	26	65	37	41	12	32	29.7%	10
Q3/96	No Data	No Data	No Data	No Data	No Data	No Data	No Data	No Data
Q4/96	25	65	34	39	14	27	25.6%	7
Q1/97	7	55	36	33	18	7	31.0%	9
Q2/97 & Q3/97	No Data Collected							
Q4/97	18	60	35	35	8	25	10.4%	48
Q1/98	17	55	34	37	10	27	24.0%	25

**2) 92nd Ave. NE (Yarrow Point) Overpass to Pedestrian Overpass at Hunts Point**

Quarter	Min.	Max	Median	AVG.	SD	Speed (mph) >90%	Percent >45 mph	Number of Data Points
Q4/95	41	57	44	47	6	42	41.5%	8
Q1/96	42	58	55	53	5	48	95.3%	10
Q2/96	40	60	52	51	7	43	77.8%	10
Q3/96	No Data	No Data	No Data	No Data	No Data	No Data	No Data	No Data
Q4/96	47	60	50	53	5	48	100.0%	7
Q1/97	35	58	46	48	8	35	76.6%	9
Q2/97 & Q3/97	No Data Collected							
Q4/97	35	62	48	48	6	40	77.1%	48
Q1/98	38	60	50	50	7	40	68.0%	25

**3) SR 908 Overpass (Bellevue Way) to 92nd Ave. NE (Yarrow Point) Overpass**

Quarter	Min.	Max	Median	AVG.	SD	Speed (mph) >90%	Percent >45 mph	Number of Data Points
Q4/95	38	58	44	47	7	41	41.5%	8
Q1/96	50	58	56	55	2	53	100.0%	10
Q2/96	34	60	52	49	8	39	66.7%	10
Q3/96	No Data	No Data	No Data	No Data	No Data	No Data	No Data	No Data
Q4/96	44	59	55	53	4	48	98.2%	8
Q1/97	36	56	48	47	8	36	59.0%	10
Q2/97 & Q3/97	No Data Collected							
Q4/97	32	60	51	49	7	40	72.0%	50
Q1/98	34	58	51	48	7	38	65.4%	26

**SR 520 CORRIDOR, P.M. WESTBOUND**

**1) Pedestrian Overpass at Hunts Point to 76th Ave. NE (Evergreen Point Rd.)**

Quarter	Min.	Max	Median	AVG.	SD	Speed (mph) >90%	Percent >45 mph	Number of Data Points
Q4/95	33	55	46	47	7	36	62.5%	9
Q1/96	28	55	41	41	11	30	46.9%	10
Q2/96	27	42	30	31	4	28	0.0%	10
Q3/96	No Data	No Data	No Data	No Data	No Data	No Data	No Data	No Data
Q4/96	21	55	28	31	10	22	6.6%	10
Q1/97	No Data	No Data	No Data	No Data	No Data	No Data	No Data	No Data
Q2/97 & Q3/97	No Data Collected							
Q4/97	19	55	32	32	8	20	6.7%	30
Q1/98	23	55	35	37	9	29	16.7%	30

**2) 92nd Ave. NE (Yarrow Point) Overpass to Pedestrian Overpass at Hunts Point**

Quarter	Min.	Max	Median	AVG.	SD	Speed (mph) >90%	Percent >45 mph	Number of Data Points
Q4/95	31	58	50	47	10	32	63.9%	9
Q1/96	31	57	50	47	9	36	59.3%	10
Q2/96	32	57	44	44	8	32	37.5%	9
Q3/96	No Data	No Data	No Data	No Data	No Data	No Data	No Data	No Data
Q4/96	29	60	46	45	9	33	56.0%	10
Q1/97	No Data	No Data	No Data	No Data	No Data	No Data	No Data	No Data
Q2/97 & Q3/97	No Data Collected							
Q4/97	26	59	43	43	8	33	33.3%	30
Q1/98	32	63	49	50	9	39	64.5%	31

**3) SR 908 Overpass (Bellevue Way) to 92nd Ave. NE (Yarrow Point) Overpass**

Quarter	Min.	Max	Median	AVG.	SD	Speed (mph) >90%	Percent >45 mph	Number of Data Points
Q4/95	23	60	52	42	16	23	54.0%	9
Q1/96	31	56	53	49	9	36	73.2%	10
Q2/96	37	56	48	47	7	38	60.8%	8
Q3/96	No Data	No Data	No Data	No Data	No Data	No Data	No Data	No Data
Q4/96	37	58	51	49	6	41	79.6%	10
Q1/97	No Data	No Data	No Data	No Data	No Data	No Data	No Data	No Data
Q2/97 & Q3/97	No Data Collected							
Q4/97	26	59	41	42	10	27	41.4%	29
Q1/98	26	60	54	52	9	40	77.4%	31

Travel Time Sections  
I-90 (Corridor #5)

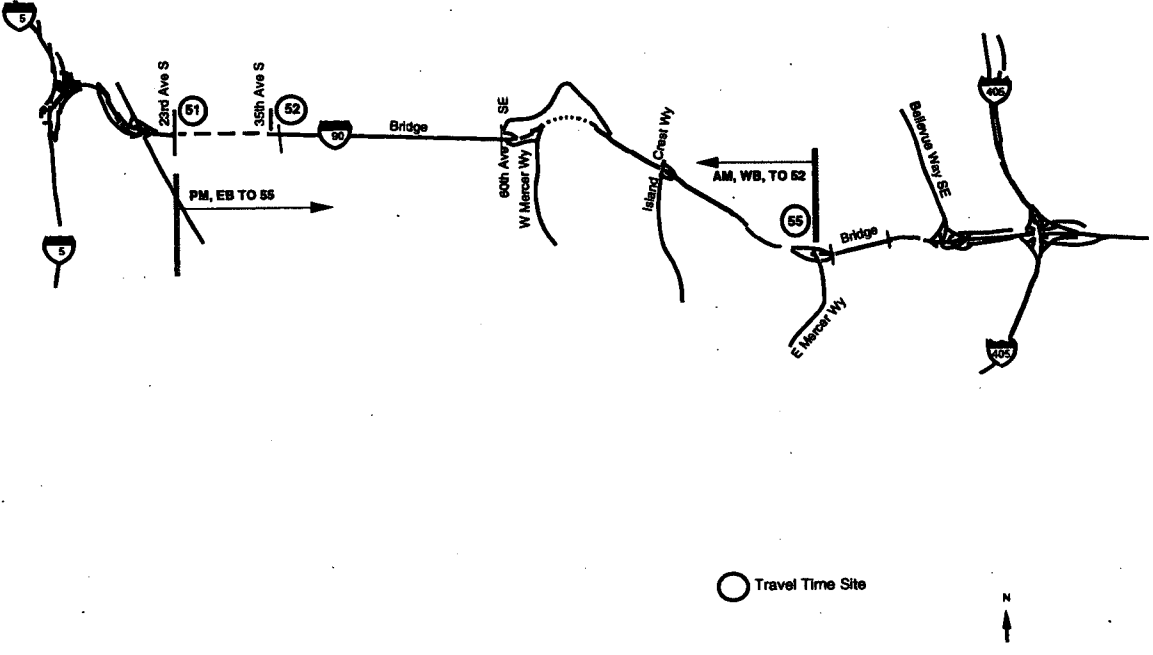

# Travel Time Sections I-90

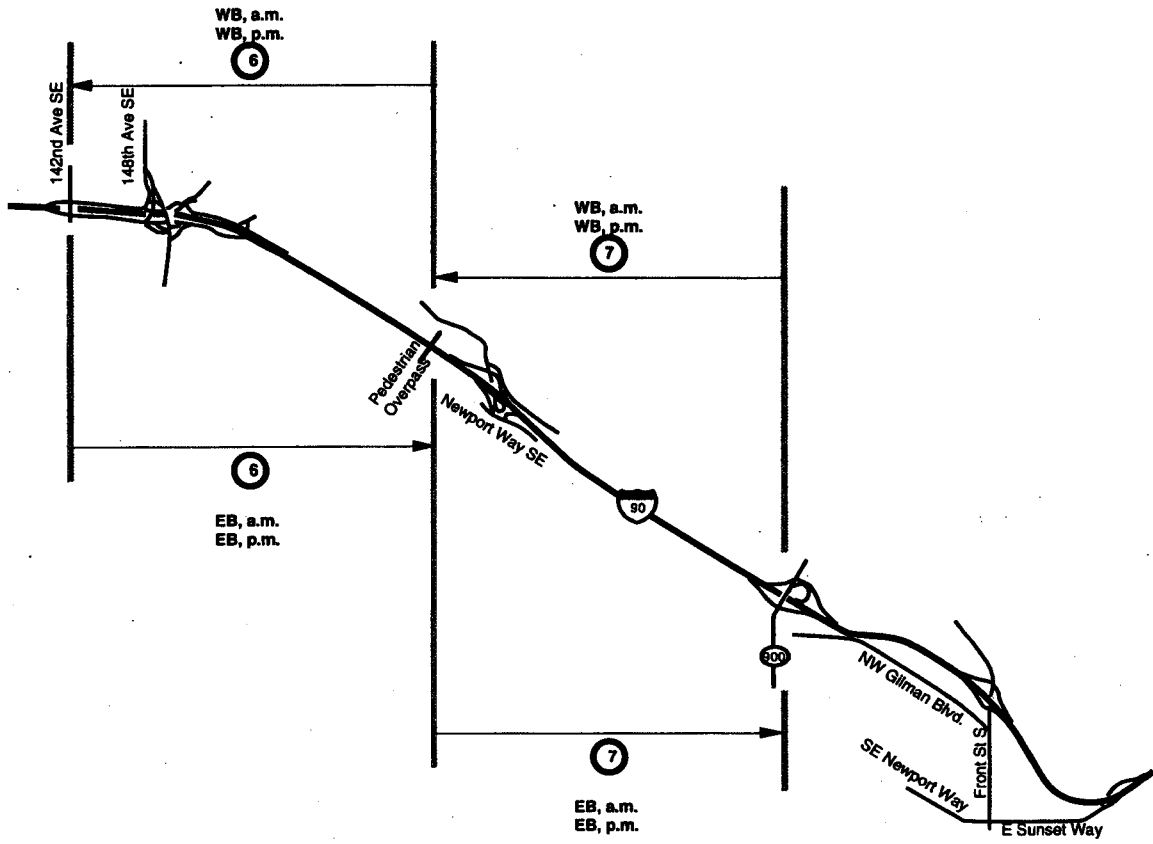

○ Travel Time Site





**I-90 CORRIDOR, A.M. WESTBOUND**

**1) East Side of Mt. Baker Tunnel to the West Side of Mt. Baker Lid**

Quarter	Min.	Max	Median	AVG.	SD	Speed (mph) >90%	Percent >45 mph	Number of Data Points
Q4/95	54	62	58	58	2	56	100.0%	9
Q1/96	50	60	54	55	3	52	100.0%	8
Q2/96	43	63	60	58	6	52	97.9%	8
Q3/96	No Data	No Data	No Data	No Data	No Data	No Data	No Data	No Data
Q4/96	48	60	54	54	6	48	100.0%	4
Q1/97	50	57	52	52	2	50	100.0%	12
Q2/97 & Q3/97	No Data Collected							
Q4/97	53	62	57	58	2	55	100.0%	23
Q1/98	17	65	59	55	9	42	89.5%	38

**2) West Side of the Mercer Lid to the East Side of the Mt. Baker Tunnel**

Quarter	Min.	Max	Median	AVG.	SD	Speed (mph) >90%	Percent >45 mph	Number of Data Points
Q4/95	57	66	61	61	2	59	100.0%	10
Q1/96	55	70	59	60	5	56	100.0%	8
Q2/96	59	64	61	61	1	60	100.0%	8
Q3/96	No Data	No Data	No Data	No Data	No Data	No Data	No Data	No Data
Q4/96	56	58	58	57	1	56	100.0%	4
Q1/97	55	66	57	58	3	56	100.0%	12
Q2/97 & Q3/97	No Data Collected							
Q4/97	59	68	62	62	2	59	100.0%	23
Q1/98	59	68	63	63	2	61	100.0%	38

**3) Island Crest Way Overpass to West Side of the Mercer Lid**

Quarter	Min.	Max	Median	AVG.	SD	Speed (mph) >90%	Percent >45 mph	Number of Data Points
Q4/95	55	69	60	61	4	58	100.0%	10
Q1/96	55	67	60	60	3	57	100.0%	9
Q2/96	60	63	62	62	1	61	100.0%	8
Q3/96	No Data	No Data	No Data	No Data	No Data	No Data	No Data	No Data
Q4/96	60	62	61	61	1	60	100.0%	4
Q1/97	48	68	54	55	5	51	100.0%	12
Q2/97 & Q3/97	No Data Collected							
Q4/97	51	67	61	60	4	55	100.0%	23
Q1/98	55	65	61	61	2	58	100.0%	38

**I-90 CORRIDOR, A.M. WESTBOUND**

**4) East Mercer Way Overpass to Island Crest Way Overpass**

Quarter	Min.	Max	Median	AVG.	SD	Speed (mph) >90%	Percent >45 mph	Number of Data Points
Q4/95	55	73	61	63	6	57	100.0%	9
Q1/96	55	67	61	61	3	59	100.0%	9
Q2/96	51	65	62	61	4	57	100.0%	7
Q3/96	No Data	No Data	No Data	No Data	No Data	No Data	No Data	No Data
Q4/96	50	65	62	61	5	56	100.0%	7
Q1/97	47	60	56	55	3	51	100.0%	12
Q2/97 & Q3/97	No Data Collected							
Q4/97	57	70	62.5	63	3	59	100.0%	22
Q1/98	53	70	63	63	3	58	100.0%	38

**5) 142nd Ave. SE Overpass to East Mercer Way Overpass**

Quarter	Min.	Max	Median	AVG.	SD	Speed (mph) >90%	Percent >45 mph	Number of Data Points
Q4/95	53	63	59	59	3	56	100.0%	12
Q1/96	49	65	62	60	4	56	100.0%	12
Q2/96	55	62	61	59	3	55	100.0%	9
Q3/96	No Data	No Data	No Data	No Data	No Data	No Data	No Data	No Data
Q4/96	62	64	63	63	1	62	100.0%	4
Q1/97	53	57	56	56	1	55	100.0%	9
Q2/97 & Q3/97	No Data Collected							
Q4/97	58	64	62.5	62	2	58	100.0%	10
Q1/98	52	68	63	63	3	60	100.0%	18

**6) Newport Way Pedestrian Overpass to 142nd Ave. SE Overpass**

Quarter	Min.	Max	Median	AVG.	SD	Speed (mph) >90%	Percent >45 mph	Number of Data Points
Q4/95	55	65	61	60	3	57	100.0%	13
Q1/96	51	64	61	59	4	52	100.0%	12
Q2/96	54	62	60	59	3	55	100.0%	9
Q3/96	No Data	No Data	No Data	No Data	No Data	No Data	No Data	No Data
Q4/96	61	63	63	63	1	62	100.0%	4
Q1/97	55	58	56	56	1	55	100.0%	9
Q2/97 & Q3/97	No Data Collected							
Q4/97	59	63	61.5	61	1	59	100.0%	10
Q1/98	58	66	63	63	2	59	100.0%	18

**I-90 CORRIDOR, A.M. WESTBOUND****7) SR 900 Overpass to Newport Way Pedestrian Overpass**

Quarter	Min.	Max	Median	AVG.	SD	Speed (mph) >90%	Percent >45 mph	Number of Data Points
Q4/95	55	64	61	60	3	56	100.0%	13
Q1/96	54	65	63	61	4	54	100.0%	12
Q2/96	58	61	60	60	1	59	100.0%	9
Q3/96	No Data	No Data	No Data	No Data	No Data	No Data	No Data	No Data
Q4/96	61	63	62	62	1	61	100.0%	4
Q1/97	54	56	55	55	1	54	100.0%	9
Q2/97 & Q3/97	No Data Collected							
Q4/97	58	62	62	61	1	58	100.0%	10
Q1/98	60	65	63	62	1	60	100.0%	18

**I-90 CORRIDOR, P.M. WESTBOUND**

**5) 142nd Ave. SE Overpass to East Mercer Way Overpass**

Quarter	Min.	Max	Median	AVG.	SD	Speed (mph) >90%	Percent >45 mph	Number of Data Points
Q4/95	56	61	60	59	2	57	100.0%	8
Q1/96	33	61	60	55	9	45	89.8%	10
Q2/96	39	64	61	56	10	40	81.8%	8
Q3/96	No Data	No Data	No Data	No Data	No Data	No Data	No Data	No Data
Q4/96	44	61	58	56	7	48	98.5%	4
Q1/97	No Data	No Data	No Data	No Data	No Data	No Data	No Data	No Data
Q2/97 & Q3/97	No Data Collected							
Q4/97	19	65	60	52	17	21	77.8%	27
Q1/98	41	64	63	60	6	49	93.8%	16

**6) Newport Way Pedestrian Overpass to 142nd Ave. SE Overpass**

Quarter	Min.	Max	Median	AVG.	SD	Speed (mph) >90%	Percent >45 mph	Number of Data Points
Q4/95	54	66	59	59	3	55	100.0%	8
Q1/96	46	62	61	59	4	57	100.0%	10
Q2/96	61	63	62	62	1	61	100.0%	8
Q3/96	No Data	No Data	No Data	No Data	No Data	No Data	No Data	No Data
Q4/96	60	62	61	61	1	60	100.0%	5
Q1/97	No Data	No Data	No Data	No Data	No Data	No Data	No Data	No Data
Q2/97 & Q3/97	No Data Collected							
Q4/97	44	66	62	61	4	60	96.6%	29
Q1/98	62	67	64	64	1	62	100.0%	16

**7) SR 900 Overpass to Newport Way Pedestrian Overpass**

Quarter	Min.	Max	Median	AVG.	SD	Speed (mph) >90%	Percent >45 mph	Number of Data Points
Q4/95	57	62	59	59	1	58	100.0%	8
Q1/96	57	60	59	59	1	58	100.0%	10
Q2/96	61	63	62	62	1	61	100.0%	8
Q3/96	No Data	No Data	No Data	No Data	No Data	No Data	No Data	No Data
Q4/96	60	61	61	61	1	60	100.0%	5
Q1/97	No Data	No Data	No Data	No Data	No Data	No Data	No Data	No Data
Q2/97 & Q3/97	No Data Collected							
Q4/97	58	65	62	62	2	59	100.0%	29
Q1/98	61	65	63	63	1	61	100.0%	16

**I-90 CORRIDOR, A.M. EASTBOUND**

**5) East Mercer Way Overpass to 142nd Ave. SE Overpass**

Quarter	Min.	Max	Median	AVG.	SD	Speed (mph) >90%	Percent >45 mph	Number of Data Points
Q4/95	53	65	62	61	3	58	100.0%	10
Q1/96	57	71	62	61	4	57	100.0%	11
Q2/96	59	66	61	61	2	60	100.0%	11
Q3/96	No Data	No Data	No Data	No Data	No Data	No Data	No Data	No Data
Q4/96	58	65	59	61	3	58	100.0%	3
Q1/97	55	56	55	56	0	55	100.0%	9
Q2/97 & Q3/97	No Data Collected							
Q4/97	52	63	63	61	4	53	100.0%	10
Q1/98	57	67	61	61	3	58	100.0%	18

**6) 142nd Ave. SE Overpass to Newport Way Pedestrian Overpass**

Quarter	Min.	Max	Median	AVG.	SD	Speed (mph) >90%	Percent >45 mph	Number of Data Points
Q4/95	56	66	61	61	4	57	100.0%	12
Q1/96	55	66	62	61	3	57	100.0%	12
Q2/96	53	62	60	60	2	60	100.0%	11
Q3/96	No Data	No Data	No Data	No Data	No Data	No Data	No Data	No Data
Q4/96	63	65	63	64	1	63	100.0%	3
Q1/97	49	57	56	55	2	52	100.0%	9
Q2/97 & Q3/97	No Data Collected							
Q4/97	58	63	63	62	2	58	100.0%	10
Q1/98	27	65	64	61	9	60	94.7%	19

**7) Newport Way Pedestrian Overpass to SR 900 Overpass**

Quarter	Min.	Max	Median	AVG.	SD	Speed (mph) >90%	Percent >45 mph	Number of Data Points
Q4/95	54	67	59	61	5	56	100.0%	12
Q1/96	51	63	62	60	4	54	100.0%	12
Q2/96	59	65	61	61	2	60	100.0%	11
Q3/96	No Data	No Data	No Data	No Data	No Data	No Data	No Data	No Data
Q4/96	61	63	63	62	1	61	100.0%	3
Q1/97	55	61	56	57	2	55	100.0%	9
Q2/97 & Q3/97	No Data Collected							
Q4/97	59	63	62	62	1	59	100.0%	10
Q1/98	50	65	63	62	3	60	100.0%	19

**I-90 CORRIDOR, P.M. EASTBOUND**

**1) West Side of Mt. Baker Lid to East Side of Mt. Baker Tunnel**

Quarter	Min.	Max	Median	AVG.	SD	Speed (mph) >90%	Percent >45 mph	Number of Data Points
Q4/95	53	62	57	56	3	53	100.0%	10
Q1/96	46	62	57	56	4	50	100.0%	16
Q2/96	52	62	58	58	2	54	100.0%	17
Q3/96	No Data	No Data	No Data	No Data	No Data	No Data	No Data	No Data
Q4/96	38	60	56	54	6	51	95.1%	12
Q1/97	48	60	56	55	4	51	100.0%	10
Q2/97 & Q3/97	No Data Collected							
Q4/97	47	71	59	59	4	53	100.0%	58
Q1/98	53	63	60	59	3	56	100.0%	39

**2) East Side of the Mt. Baker Tunnel to West Side of the Mercer Lid**

Quarter	Min.	Max	Median	AVG.	SD	Speed (mph) >90%	Percent >45 mph	Number of Data Points
Q4/95	56	64	62	61	2	58	100.0%	10
Q1/96	57	66	61	61	3	58	100.0%	16
Q2/96	59	65	61	62	2	60	100.0%	17
Q3/96	No Data	No Data	No Data	No Data	No Data	No Data	No Data	No Data
Q4/96	53	66	63	62	3	60	100.0%	12
Q1/97	57	63	61	61	2	57	100.0%	10
Q2/97 & Q3/97	No Data Collected							
Q4/97	51	67	63	62	3	59	100.0%	59
Q1/98	56	67	63	63	2	60	100.0%	39

**3) West Side of the Mercer Lid to Island Crest Way Overpass**

Quarter	Min.	Max	Median	AVG.	SD	Speed (mph) >90%	Percent >45 mph	Number of Data Points
Q4/95	55	71	61	62	4	56	100.0%	11
Q1/96	55	66	61	60	3	56	100.0%	16
Q2/96	58	64	61	61	2	60	100.0%	17
Q3/96	No Data	No Data	No Data	No Data	No Data	No Data	No Data	No Data
Q4/96	56	70	60	61	4	57	100.0%	12
Q1/97	55	61	59	59	2	57	100.0%	10
Q2/97 & Q3/97	No Data Collected							
Q4/97	49	69	61	60	4	55	98.3%	59
Q1/98	54	66	63	62	2	59	100.0%	39

**I-90 CORRIDOR, P.M. EASTBOUND**

**4) Island Crest Way Overpass to East Mercer Way Overpass**

Quarter	Min.	Max	Median	AVG.	SD	Speed (mph) >90%	Percent >45 mph	Number of Data Points
Q4/95	53	69	60	60	4	56	100.0%	10
Q1/96	54	63	59	58	3	55	100.0%	16
Q2/96	56	64	60	60	2	58	100.0%	17
Q3/96	No Data	No Data	No Data	No Data	No Data	No Data	No Data	No Data
Q4/96	50	63	58	58	4	52	100.0%	12
Q1/97	56	62	59	59	2	56	100.0%	10
Q2/97 & Q3/97	No Data Collected							
Q4/97	37	69	61	61	4	58	100.0%	60
Q1/98	57	66	62	62	2	59	100.0%	39

**5) East Mercer Way Overpass to 142nd Ave. SE Overpass**

Quarter	Min.	Max	Median	AVG.	SD	Speed (mph) >90%	Percent >45 mph	Number of Data Points
Q4/95	55	60	58	58	2	56	100.0%	7
Q1/96	54	63	58	58	3	56	100.0%	10
Q2/96	55	63	62	61	2	59	100.0%	8
Q3/96	No Data	No Data	No Data	No Data	No Data	No Data	No Data	No Data
Q4/96	57	60	58	58	1	57	100.0%	5
Q1/97	No Data	No Data	No Data	No Data	No Data	No Data	No Data	No Data
Q2/97 & Q3/97	No Data Collected							
Q4/97	55	65	61	61	2	57	100.0%	32
Q1/98	55	64	62	61	3	56	100.0%	16

**6) 142nd Ave. SE Overpass to Newport Way Pedestrian Overpass**

Quarter	Min.	Max	Median	AVG.	SD	Speed (mph) >90%	Percent >45 mph	Number of Data Points
Q4/95	57	62	60	60	1	58	100.0%	8
Q1/96	57	63	62	61	2	58	100.0%	10
Q2/96	55	63	62	61	2	59	100.0%	8
Q3/96	No Data	No Data	No Data	No Data	No Data	No Data	No Data	No Data
Q4/96	57	61	59	59	2	57	100.0%	5
Q1/97	No Data	No Data	No Data	No Data	No Data	No Data	No Data	No Data
Q2/97 & Q3/97	No Data Collected							
Q4/97	56	65	62	62	2	58	100.0%	34
Q1/98	55	65	63	62	2	57	100.0%	16

**I-90 CORRIDOR, P.M. EASTBOUND****7) Newport Way Pedestrian Overpass to SR 900 Overpass**

Quarter	Min.	Max	Median	AVG.	SD	Speed (mph) >90%	Percent >45 mph	Number of Data Points
Q4/95	58	68	59	61	3	58	100.0%	8
Q1/96	56	63	60	60	2	57	100.0%	10
Q2/96	57	63	61	61	2	60	100.0%	8
Q3/96	No Data	No Data	No Data	No Data	No Data	No Data	No Data	No Data
Q4/96	58	63	60	60	2	58	100.0%	5
Q1/97	No Data	No Data	No Data	No Data	No Data	No Data	No Data	No Data
Q2/97 & Q3/97	No Data Collected							
Q4/97	55	67	62	62	2	58	100.0%	33
Q1/98	56	65	62	62	2	59	100.0%	16



# Travel Time Sections I-405 South

○ Travel Time Site

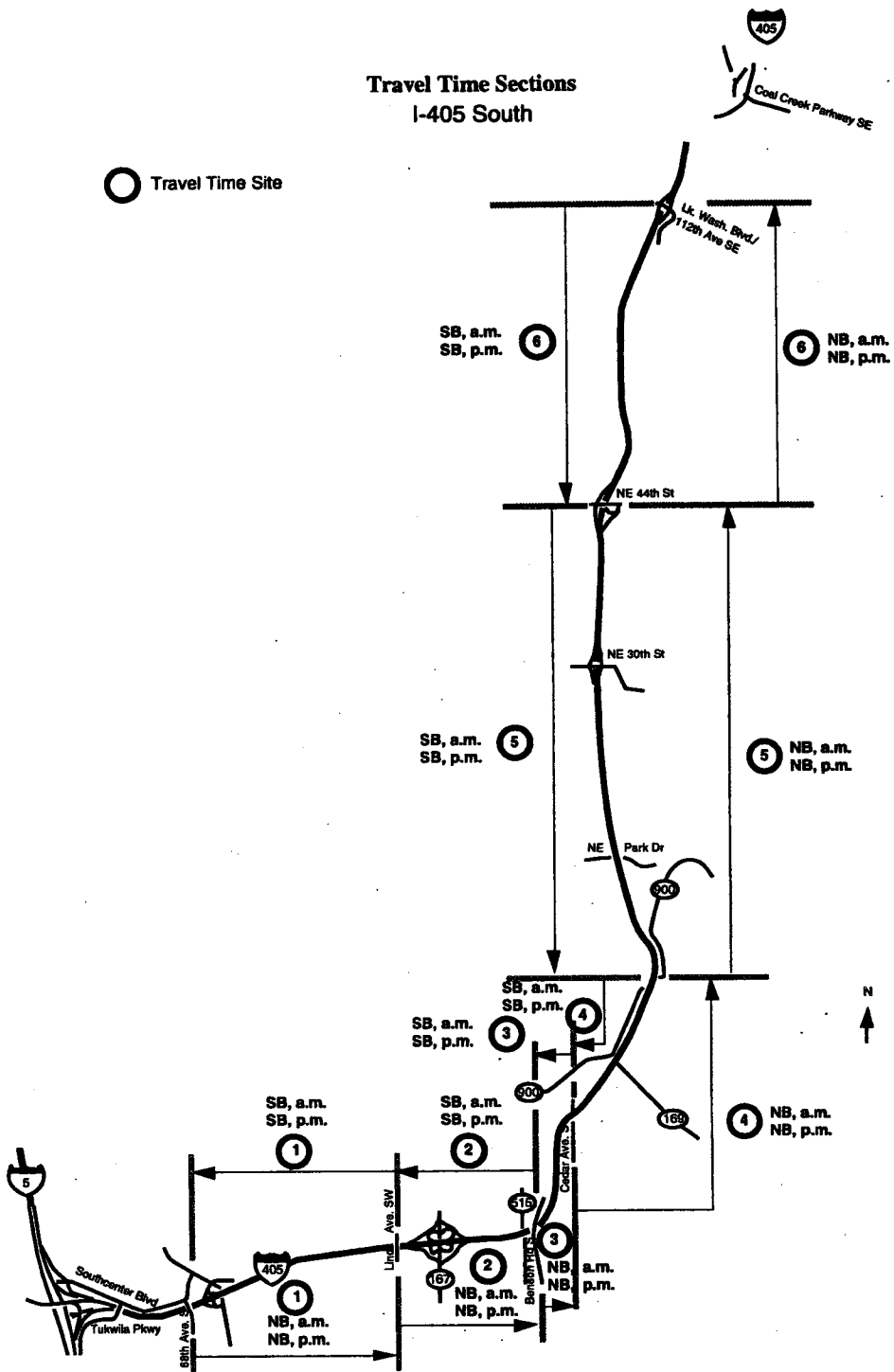

**SOUTH I-405 CORRIDOR, A.M. SOUTHBOUND**

**1) Lind Ave. SW Overpass to 68h Ave. S Overpass**

Quarter	Min.	Max	Median	AVG.	SD	Speed (mph) >90%	Percent >45 mph	Number of Data Points
Q4/95	43	64	59	57	4	53	99.0%	32
Q1/96	50	65	58	58	4	54	100.0%	39
Q2/96	53	64	60	60	3	57	100.0%	37
Q3/96	No Data	No Data	No Data	No Data	No Data	No Data	No Data	No Data
Q4/96	46	64	57	57	5	50	100.0%	25
Q1/97	53	62	56	56	2	55	100.0%	30
Q2/97 & Q3/97	No Data Collected							
Q4/97	48	65	60	58	4	51	100.0%	60
Q1/98	47	69	60	59	4	53	100.0%	76

**2) Benson Rd. Overpass to Lind Ave. SW Overpass**

Quarter	Min.	Max	Median	AVG.	SD	Speed (mph) >90%	Percent >45 mph	Number of Data Points
Q4/95	53	67	60	60	3	56	100.0%	32
Q1/96	48	67	59	59	4	55	100.0%	39
Q2/96	58	64	61	61	2	59	100.0%	37
Q3/96	No Data	No Data	No Data	No Data	No Data	No Data	No Data	No Data
Q4/96	49	64	60	59	4	54	100.0%	25
Q1/97	49	63	56	57	3	54	100.0%	30
Q2/97 & Q3/97	No Data Collected							
Q4/97	46	65	60	60	3	58	100.0%	59
Q1/98	52	67	61	61	3	56	100.0%	75

**3) S-curve Overpasses @ Renton Ave. S to Benson Rd. Overpass**

Quarter	Min.	Max	Median	AVG.	SD	Speed (mph) >90%	Percent >45 mph	Number of Data Points
Q4/95	32	76	38	40	8	34	7.6%	32
Q1/96	28	55	38	39	5	33	5.0%	39
Q2/96	33	57	41	41	4	36	2.6%	37
Q3/96	No Data	No Data	No Data	No Data	No Data	No Data	No Data	No Data
Q4/96	46	63	54	54	5	47	100.0%	25
Q1/97	43	60	54	53	4	49	95.5%	30
Q2/97 & Q3/97	No Data Collected							
Q4/97	41	69	58	56	6	47	95.0%	60
Q1/98	42	65	55	55	6	47	93.3%	75

**SOUTH I-405 CORRIDOR, A.M. SOUTHBOUND**

**4) SR 900 Underpass (NE Park Drive) to S-curve Overpasses @ Renton Ave. S**

Quarter	Min.	Max	Median	AVG.	SD	Speed (mph) >90%	Percent >45 mph	Number of Data Points
Q4/95	17	72	54	55	14	39	77.5%	32
Q1/96	25	75	60	57	12	42	81.6%	39
Q2/96	29	75	65	62	10	51	95.7%	37
Q3/96	No Data	No Data	No Data	No Data	No Data	No Data	No Data	No Data
Q4/96	31	63	51	48	11	32	61.1%	25
Q1/97	45	60	56	56	3	51	100.0%	30
Q2/97 & Q3/97	No Data Collected							
Q4/97	45	65	58	57	5	49	100.0%	61
Q1/98	45	67	61	59	6	49	100.0%	74

**5) NE 44th St. Overpass to SR 900 Underpass (NE Park Drive)**

Quarter	Min.	Max	Median	AVG.	SD	Speed (mph) >90%	Percent >45 mph	Number of Data Points
Q4/95	37	70	57	54	8	45	90.4%	32
Q1/96	36	62	55	54	6	47	95.2%	39
Q2/96	39	63	56	55	6	48	91.7%	37
Q3/96	No Data	No Data	No Data	No Data	No Data	No Data	No Data	No Data
Q4/96	34	60	47	49	7	42	71.7%	25
Q1/97	42	64	55	55	4	50	97.6%	30
Q2/97 & Q3/97	No Data Collected							
Q4/97	44	64	57	57	5	49	98.4%	61
Q1/98	43	64	58	57	4	51	98.6%	74

**6) 112th Ave. SE (Lake Washington Blvd.) Overpass to NE 44th St. Overpass**

Quarter	Min.	Max	Median	AVG.	SD	Speed (mph) >90%	Percent >45 mph	Number of Data Points
Q4/95	41	63	58	56	5	49	95.2%	32
Q1/96	50	63	58	58	2	55	100.0%	32
Q2/96	38	66	60	57	7	44	89.6%	37
Q3/96	No Data	No Data	No Data	No Data	No Data	No Data	No Data	No Data
Q4/96	37	63	58	55	6	46	90.6%	25
Q1/97	47	64	55	56	4	52	100.0%	30
Q2/97 & Q3/97	No Data Collected							
Q4/97	47	64	60	59	4	52	100.0%	61
Q1/98	14	66	61	59	7	51	97.3%	75

**SOUTH I-405 CORRIDOR, P.M. SOUTHBOUND**

**1) Lind Ave. SW Overpass to 68h Ave. S Overpass**

Quarter	Min.	Max	Median	AVG.	SD	Speed (mph) >90%	Percent >45 mph	Number of Data Points
Q4/95	31	68	60	57	8	49	92.6%	36
Q1/96	30	62	58	54	8	44	87.8%	20
Q2/96	36	64	61	58	7	48	95.2%	32
Q3/96	No Data	No Data	No Data	No Data	No Data	No Data	No Data	No Data
Q4/96	12	63	46	44	14	28	54.7%	13
Q1/97	28	63	55	51	10	36	75.7%	24
Q2/97 & Q3/97	No Data Collected							
Q4/97	16	66	60	54	12	33	83.1%	77
Q1/98	20	65	61	56	10	41	83.3%	72

**2) Benson Rd. Overpass to Lind Ave. SW Overpass**

Quarter	Min.	Max	Median	AVG.	SD	Speed (mph) >90%	Percent >45 mph	Number of Data Points
Q4/95	31	69	60	59	7	55	96.0%	36
Q1/96	50	64	58	58	3	55	100.0%	21
Q2/96	55	64	61	60	2	57	100.0%	31
Q3/96	No Data	No Data	No Data	No Data	No Data	No Data	No Data	No Data
Q4/96	51	61	56	57	3	54	100.0%	13
Q1/97	31	65	60	57	7	49	96.5%	24
Q2/97 & Q3/97	No Data Collected							
Q4/97	37	65	60	59	5	52	97.4%	78
Q1/98	50	69	61	61	4	55	100.0%	72

**3) S-curve Overpasses @ Renton Ave. S to Benson Rd. Overpass**

Quarter	Min.	Max	Median	AVG.	SD	Speed (mph) >90%	Percent >45 mph	Number of Data Points
Q4/95	27	64	40	40	7	32	14.3%	36
Q1/96	25	42	38	36	5	31	0.0%	20
Q2/96	30	45	42	41	4	35	3.4%	31
Q3/96	No Data	No Data	No Data	No Data	No Data	No Data	No Data	No Data
Q4/96	44	61	49	51	6	45	89.9%	14
Q1/97	35	64	56	54	8	39	83.4%	25
Q2/97 & Q3/97	No Data Collected							
Q4/97	27	64	59	56	8	44	89.7%	78
Q1/98	30	64	59	55	9	40	86.1%	72

**SOUTH I-405 CORRIDOR, P.M. SOUTHBOUND**

**4) SR 900 Underpass (NE Park Drive) to S-curve Overpasses @ Renton Ave. S**

Quarter	Min.	Max	Median	AVG.	SD	Speed (mph) >90%	Percent >45 mph	Number of Data Points
Q4/95	26	75	67	61	13	40	83.8%	38
Q1/96	18	69	58	51	16	25	67.2%	20
Q2/96	27	75	69	64	14	37	87.8%	31
Q3/96	No Data	No Data	No Data	No Data	No Data	No Data	No Data	No Data
Q4/96	18	59	41	42	11	32	46.3%	14
Q1/97	42	64	59	57	6	48	94.4%	25
Q2/97 & Q3/97	No Data Collected							
Q4/97	24	67	61	59	7	51	94.9%	78
Q1/98	38	67	62	60	6	51	95.8%	72

**5) NE 44th St. Overpass to SR 900 Underpass (NE Park Drive)**

Quarter	Min.	Max	Median	AVG.	SD	Speed (mph) >90%	Percent >45 mph	Number of Data Points
Q4/95	25	60	53	50	8	39	81.1%	38
Q1/96	34	60	48	47	7	36	65.0%	21
Q2/96	29	62	56	54	7	48	91.6%	32
Q3/96	No Data	No Data	No Data	No Data	No Data	No Data	No Data	No Data
Q4/96	24	54	45	44	8	34	52.4%	14
Q1/97	31	64	55	51	9	40	77.3%	25
Q2/97 & Q3/97	No Data Collected							
Q4/97	31	64	56.5	55	6	45	91.0%	78
Q1/98	34	64	57	56	6	47	95.8%	72

**6) 112th Ave. SE (Lake Washington Blvd.) Overpass to NE 44th St. Overpass**

Quarter	Min.	Max	Median	AVG.	SD	Speed (mph) >90%	Percent >45 mph	Number of Data Points
Q4/95	43	67	57	56	5	47	93.3%	38
Q1/96	32	64	54	52	8	42	86.3%	21
Q2/96	47	66	60	60	4	56	100.0%	32
Q3/96	No Data	No Data	No Data	No Data	No Data	No Data	No Data	No Data
Q4/96	25	57	50	48	9	36	79.1%	14
Q1/97	34	62	57	55	6	49	96.5%	25
Q2/97 & Q3/97	No Data Collected							
Q4/97	37	66	60	58	6	50	94.8%	77
Q1/98	46	65	61	60	4	53	100.0%	72

**SOUTH I-405 CORRIDOR, A.M. NORTHBOUND**

**1) 68h Ave. S Overpass to Lind Ave. SW Overpass**

Quarter	Min.	Max	Median	AVG.	SD	Speed (mph) >90%	Percent >45 mph	Number of Data Points
Q4/95	52	66	60	60	3	57	100.0%	32
Q1/96	45	64	60	59	3	57	100.0%	43
Q2/96	58	64	61	62	1	60	100.0%	35
Q3/96	No Data	No Data	No Data	No Data	No Data	No Data	No Data	No Data
Q4/96	51	67	60	60	4	56	100.0%	23
Q1/97	54	65	56	57	3	55	100.0%	28
Q2/97 & Q3/97	No Data Collected							
Q4/97	41	66	61	60	5	56	96.2%	53
Q1/98	31	67	53	53	8	42	83.3%	66

**2) Lind Ave. SW Overpass to Benson Rd. Overpass**

Quarter	Min.	Max	Median	AVG.	SD	Speed (mph) >90%	Percent >45 mph	Number of Data Points
Q4/95	45	65	60	58	5	51	100.0%	32
Q1/96	53	63	59	59	2	56	100.0%	42
Q2/96	58	65	61	62	2	59	100.0%	35
Q3/96	No Data	No Data	No Data	No Data	No Data	No Data	No Data	No Data
Q4/96	50	70	60	59	5	52	100.0%	23
Q1/97	51	64	55	56	3	53	100.0%	28
Q2/97 & Q3/97	No Data Collected							
Q4/97	49	64	60	60	3	55	100.0%	54
Q1/98	39	65	58	57	5	52	98.5%	67

**3) Benson Rd. Overpass to S-curve Overpasses @ Cedar Ave.**

Quarter	Min.	Max	Median	AVG.	SD	Speed (mph) >90%	Percent >45 mph	Number of Data Points
Q4/95	24	65	44	42	9	31	46.9%	33
Q1/96	28	50	43	42	4	36	19.6%	42
Q2/96	35	49	45	45	3	41	71.5%	36
Q3/96	No Data	No Data	No Data	No Data	No Data	No Data	No Data	No Data
Q4/96	42	65	60	57	7	45	90.1%	23
Q1/97	37	62	56	55	5	51	95.6%	28
Q2/97 & Q3/97	No Data Collected							
Q4/97	44	68	62	60	5	53	98.1%	54
Q1/98	35	64	55	54	6	46	92.5%	67

**SOUTH I-405 CORRIDOR, A.M. NORTHBOUND**

**4) S-curve Overpasses @ Cedar Ave. S to SR 900 Underpass (NE Park Drive)**

Quarter	Min.	Max	Median	AVG.	SD	Speed (mph) >90%	Percent >45 mph	Number of Data Points
Q4/95	28	66	48	48	13	31	56.3%	33
Q1/96	32	70	50	50	10	36	67.1%	42
Q2/96	19	72	62	59	11	45	90.0%	36
Q3/96	No Data	No Data	No Data	No Data	No Data	No Data	No Data	No Data
Q4/96	15	64	39	40	13	23	29.3%	24
Q1/97	14	61	47	45	10	31	56.8%	28
Q2/97 & Q3/97	No Data Collected							
Q4/97	17	64	56	53	9	37	87.0%	54
Q1/98	33	66	62	61	5	59	97.0%	67

**5) SR 900 Underpass (NE Park Drive) to NE 44th St. Overpass**

Quarter	Min.	Max	Median	AVG.	SD	Speed (mph) >90%	Percent >45 mph	Number of Data Points
Q4/95	38	67	52	52	8	42	81.3%	33
Q1/96	40	63	52	51	5	44	87.9%	42
Q2/96	40	64	55	54	6	46	91.5%	36
Q3/96	No Data	No Data	No Data	No Data	No Data	No Data	No Data	No Data
Q4/96	14	64	40	40	14	20	35.4%	24
Q1/97	41	57	49	49	4	43	80.1%	28
Q2/97 & Q3/97	No Data Collected							
Q4/97	19	63	50	47	11	31	71.4%	56
Q1/98	56	65	62	61	2	58	100.0%	66

**6) NE 44th St. Overpass to 112th Ave. SE (Lake Washington Blvd.) Overpass**

Quarter	Min.	Max	Median	AVG.	SD	Speed (mph) >90%	Percent >45 mph	Number of Data Points
Q4/95	29	64	53	52	8	42	84.4%	33
Q1/96	47	67	55	55	4	50	100.0%	37
Q2/96	45	63	58	56	5	50	100.0%	36
Q3/96	No Data	No Data	No Data	No Data	No Data	No Data	No Data	No Data
Q4/96	31	63	51	50	7	43	80.1%	24
Q1/97	33	58	53	51	5	45	90.3%	27
Q2/97 & Q3/97	No Data Collected							
Q4/97	28	61	53	50	8	38	80.4%	56
Q1/98	35	67	62	61	5	58	95.4%	65

**SOUTH I-405 CORRIDOR, P.M. NORTHBOUND**

**1) 68h Ave. S Overpass to Lind Ave. SW Overpass**

Quarter	Min.	Max	Median	AVG.	SD	Speed (mph) >90%	Percent >45 mph	Number of Data Points
Q4/95	45	63	56	55	5	47	100.0%	38
Q1/96	47	62	55	55	3	52	100.0%	21
Q2/96	46	63	60	58	4	54	100.0%	29
Q3/96	No Data	No Data	No Data	No Data	No Data	No Data	No Data	No Data
Q4/96	50	62	54	55	3	51	100.0%	12
Q1/97	38	62	54	54	6	48	96.1%	26
Q2/97 & Q3/97	No Data Collected							
Q4/97	46	63	57	57	4	51	100.0%	67
Q1/98	46	66	59	58	5	50	100.0%	74

**2) Lind Ave. SW Overpass to Benson Rd. Overpass**

Quarter	Min.	Max	Median	AVG.	SD	Speed (mph) >90%	Percent >45 mph	Number of Data Points
Q4/95	47	63	56	56	5	51	100.0%	38
Q1/96	49	64	58	57	4	53	100.0%	21
Q2/96	51	64	60	60	3	58	100.0%	29
Q3/96	No Data	No Data	No Data	No Data	No Data	No Data	No Data	No Data
Q4/96	43	61	53	52	5	44	88.9%	12
Q1/97	51	67	60	58	4	52	100.0%	26
Q2/97 & Q3/97	No Data Collected							
Q4/97	42	65	60	59	4	54	98.6%	69
Q1/98	41	69	63	61	5	54	97.3%	74

**3) Benson Rd. Overpass to S-curve Overpasses @ Cedar Ave.**

Quarter	Min.	Max	Median	AVG.	SD	Speed (mph) >90%	Percent >45 mph	Number of Data Points
Q4/95	34	64	43	43	6	35	27.1%	38
Q1/96	34	48	43	42	4	36	15.0%	21
Q2/96	37	53	45	44	3	41	48.3%	30
Q3/96	No Data	No Data	No Data	No Data	No Data	No Data	No Data	No Data
Q4/96	33	59	49	47	7	38	69.7%	12
Q1/97	42	65	60	58	6	48	95.3%	26
Q2/97 & Q3/97	No Data Collected							
Q4/97	47	68	60	58	5	49	100.0%	68
Q1/98	25	65	62	59	7	50	97.3%	74



**SOUTH I-405 CORRIDOR, P.M. NORTHBOUND**

**4) S-curve Overpasses @ Cedar Ave. S to SR 900 Underpass (NE Park Drive)**

Quarter	Min.	Max	Median	AVG.	SD	Speed (mph) >90%	Percent >45 mph	Number of Data Points
Q4/95	31	67	61	56	10	43	83.4%	37
Q1/96	30	69	63	56	13	34	81.3%	21
Q2/96	42	71	64	60	9	45	89.7%	30
Q3/96	No Data	No Data	No Data	No Data	No Data	No Data	No Data	No Data
Q4/96	27	43	35	36	5	30	0.0%	12
Q1/97	42	62	58	56	5	48	93.7%	26
Q2/97 & Q3/97	No Data Collected							
Q4/97	41	66	60	57	6	44	89.9%	69
Q1/98	40	73	61	59	6	49	96.0%	75

**5) SR 900 Underpass (NE Park Drive) to NE 44th St. Overpass**

Quarter	Min.	Max	Median	AVG.	SD	Speed (mph) >90%	Percent >45 mph	Number of Data Points
Q4/95	37	76	54	53	7	46	94.5%	37
Q1/96	40	62	53	52	7	42	78.4%	21
Q2/96	47	64	56	55	5	49	100.0%	30
Q3/96	No Data	No Data	No Data	No Data	No Data	No Data	No Data	No Data
Q4/96	37	49	47	45	4	41	61.1%	12
Q1/97	44	64	58	56	6	47	98.2%	26
Q2/97 & Q3/97	No Data Collected							
Q4/97	46	65	60	59	4	52	100.0%	69
Q1/98	44	65	60	59	4	53	97.3%	74

**6) NE 44th St. Overpass to 112th Ave. SE (Lake Washington Blvd.) Overpass**

Quarter	Min.	Max	Median	AVG.	SD	Speed (mph) >90%	Percent >45 mph	Number of Data Points
Q4/95	51	63	58	57	3	54	100.0%	37
Q1/96	46	63	57	55	5	48	100.0%	21
Q2/96	50	64	60	60	3	58	100.0%	30
Q3/96	No Data	No Data	No Data	No Data	No Data	No Data	No Data	No Data
Q4/96	46	59	54	54	3	52	100.0%	12
Q1/97	33	58	53	51	5	45	90.3%	27
Q2/97 & Q3/97	No Data Collected							
Q4/97	53	66	60	59	3	55	100.0%	70
Q1/98	51	64	61	61	3	58	100.0%	74

**Travel Time Sections  
I-405 North**

○ Travel Time Site

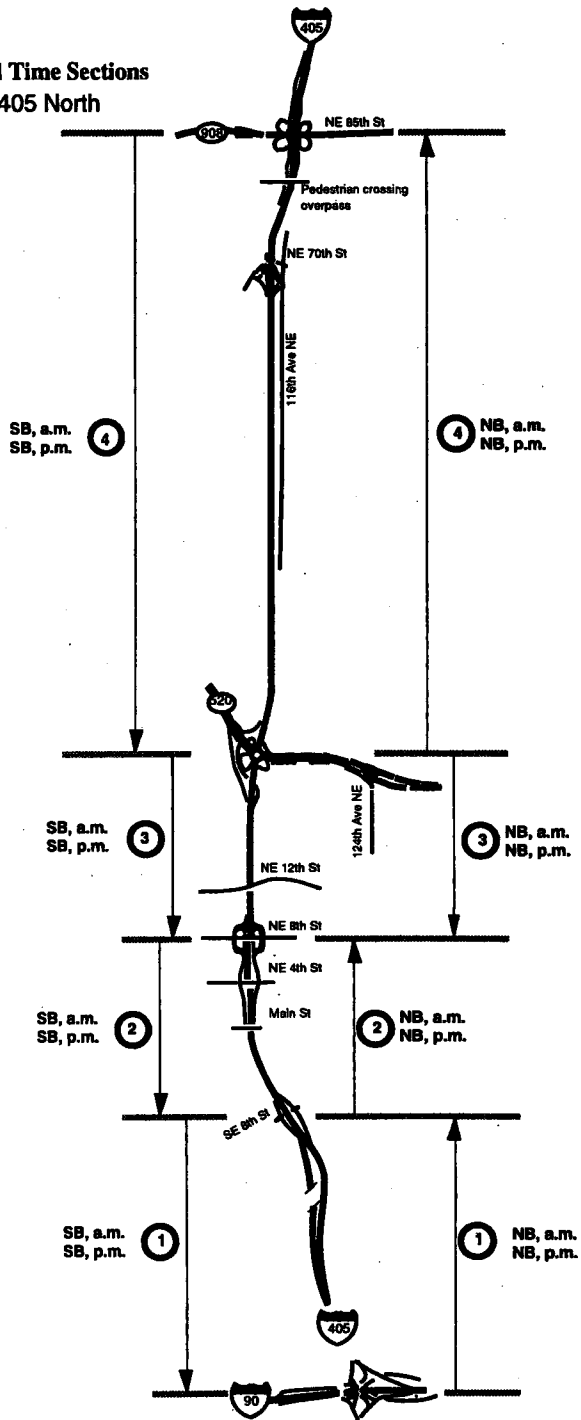

# Travel Time Sections I-405 North

○ Travel Time Site

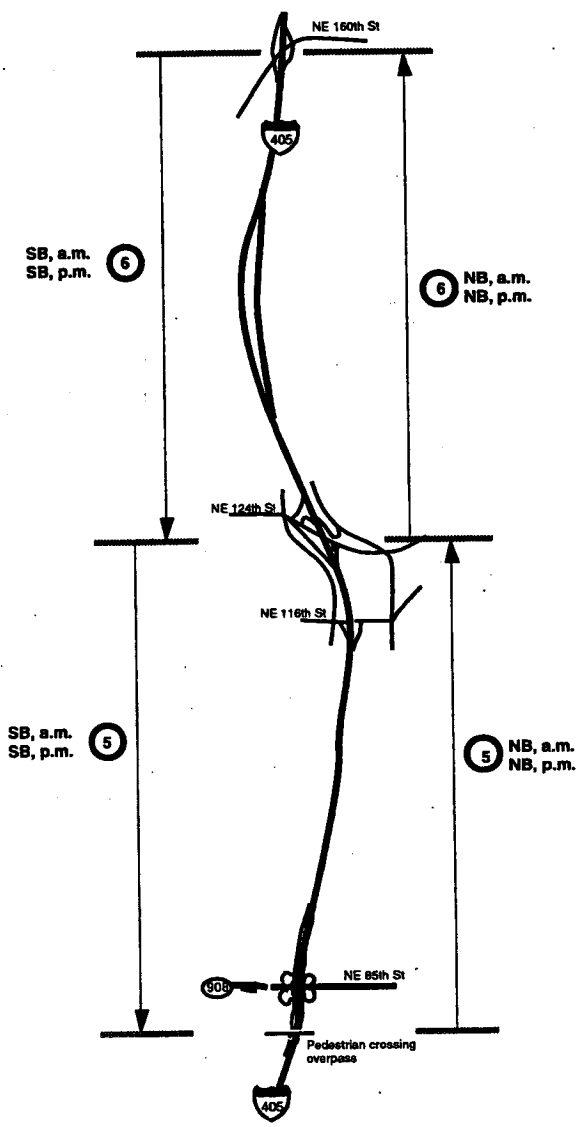

**NORTH I-405 CORRIDOR, A.M. SOUTHBOUND**

**1) SE 8th St. Underpass to I-90 Interchange Underpass**

Quarter	Min.	Max	Median	AVG.	SD	Speed (mph) >90%	Percent >45 mph	Number of Data Points
Q4/95	37	67	58	56	7	48	92.3%	32
Q1/96	28	61	57	55	6	51	94.9%	40
Q2/96	38	63	60	58	5	55	97.7%	31
Q3/96	No Data	No Data	No Data	No Data	No Data	No Data	No Data	No Data
Q4/96	51	69	60	59	4	54	100.0%	26
Q1/97	16	63	57	50	14	26	77.3%	28
Q2/97 & Q3/97	No Data Collected							
Q4/97	38	63	60	58	5	52	98.0%	50
Q1/98	23	65	60	57	10	46	91.7%	60

**2) NE 8th St. Overpass to SE 8th St. Underpass**

Quarter	Min.	Max	Median	AVG.	SD	Speed (mph) >90%	Percent >45 mph	Number of Data Points
Q4/95	24	73	58	57	8	48	95.7%	32
Q1/96	54	61	58	58	2	55	100.0%	35
Q2/96	46	64	60	59	3	56	100.0%	32
Q3/96	No Data	No Data	No Data	No Data	No Data	No Data	No Data	No Data
Q4/96	45	63	58	58	4	56	100.0%	26
Q1/97	37	61	56	55	5	51	97.3%	28
Q2/97 & Q3/97	No Data Collected							
Q4/97	52	67	58	58	3	54	100.0%	51
Q1/98	13	66	59	56	11	47	91.8%	61

**3) SR 520 E-N Ramp (Fly-over) to NE 8th St. Overpass**

Quarter	Min.	Max	Median	AVG.	SD	Speed (mph) >90%	Percent >45 mph	Number of Data Points
Q4/95	34	62	54	54	5	49	97.5%	32
Q1/96	47	68	56	56	4	52	100.0%	35
Q2/96	43	69	57	57	5	51	98.8%	32
Q3/96	No Data	No Data	No Data	No Data	No Data	No Data	No Data	No Data
Q4/96	38	62	56	56	5	52	97.8%	26
Q1/97	48	59	54	53	3	50	100.0%	28
Q2/97 & Q3/97	No Data Collected							
Q4/97	45	66	55	55	4	50	100.0%	52
Q1/98	24	65	54	53	7	44	90.2%	61

**NORTH I-405 CORRIDOR, A.M. SOUTHBOUND**

**4) Pedestrian Overpass @ SR 908 (NE 85th St.) to SR 520 E-N Ramp (Fly-over)**

Quarter	Min.	Max	Median	AVG.	SD	Speed (mph) >90%	Percent >45 mph	Number of Data Points
Q4/95	47	62	56	55	4	50	100.0%	33
Q1/96	44	67	57	56	5	49	97.1%	35
Q2/96	44	63	56	55	5	48	96.8%	32
Q3/96	No Data	No Data	No Data	No Data	No Data	No Data	No Data	No Data
Q4/96	49	65	57	56	3	51	100.0%	26
Q1/97	44	62	53	52	5	45	90.2%	28
Q2/97 & Q3/97	No Data Collected							
Q4/97	45	64	56	56	4	50	100.0%	52
Q1/98	39	62	56	55	5	48	98.4%	62

**5) NE 124th St. Overpass to Pedestrian Overpass @ SR 908 (NE 85th St.)**

Quarter	Min.	Max	Median	AVG.	SD	Speed (mph) >90%	Percent >45 mph	Number of Data Points
Q4/95	27	62	53	50	11	34	68.8%	33
Q1/96	31	60	51	51	8	43	79.5%	35
Q2/96	27	65	50	49	11	36	63.0%	32
Q3/96	No Data	No Data	No Data	No Data	No Data	No Data	No Data	No Data
Q4/96	37	61	53	51	7	42	81.8%	26
Q1/97	18	60	41	43	9	34	29.2%	28
Q2/97 & Q3/97	No Data Collected							
Q4/97	33	63	49	49	9	39	61.5%	52
Q1/98	23	66	47	47	10	34	58.1%	62

**6) NE 160th St. Overpass (Juanita - Woodinville Way) to NE 124th St. Overpass**

Quarter	Min.	Max	Median	AVG.	SD	Speed (mph) >90%	Percent >45 mph	Number of Data Points
Q4/95	44	68	59	59	5	51	97.0%	34
Q1/96	50	67	60	60	3	56	100.0%	35
Q2/96	53	65	61	60	3	56	100.0%	32
Q3/96	No Data	No Data	No Data	No Data	No Data	No Data	No Data	No Data
Q4/96	52	65	59	59	3	54	100.0%	26
Q1/97	25	63	53	53	8	47	93.2%	28
Q2/97 & Q3/97	No Data Collected							
Q4/97	48	73	59	60	5	51	100.0%	47
Q1/98	37	68	59	58	7	48	94.7%	57

**NORTH I-405 CORRIDOR, P.M. SOUTHBOUND**

**1) SE 8th St. Underpass to I-90 Interchange Underpass**

Quarter	Min.	Max	Median	AVG.	SD	Speed (mph) >90%	Percent >45 mph	Number of Data Points
Q4/95	35	58	44	47	8	37	46.5%	20
Q1/96	20	63	47	44	10	31	52.6%	27
Q2/96	13	62	51	48	11	36	63.0%	32
Q3/96	No Data	No Data	No Data	No Data	No Data	No Data	No Data	No Data
Q4/96	28	60	39	41	11	29	25.3%	12
Q1/97	15	62	39	41	15	23	41.3%	22
Q2/97 & Q3/97	No Data Collected							
Q4/97	7	60	35	35	14	19	24.0%	50
Q1/98	18	62	42	40	13	21	38.8%	49

**2) NE 8th St. Overpass to SE 8th St. Underpass**

Quarter	Min.	Max	Median	AVG.	SD	Speed (mph) >90%	Percent >45 mph	Number of Data Points
Q4/95	20	58	53	49	10	34	75.8%	20
Q1/96	9	62	54	45	15	22	65.4%	27
Q2/96	15	64	56	48	17	19	71.0%	32
Q3/96	No Data	No Data	No Data	No Data	No Data	No Data	No Data	No Data
Q4/96	16	59	39	36	14	19	33.8%	13
Q1/97	9	60	49	44	15	23	52.1%	24
Q2/97 & Q3/97	No Data Collected							
Q4/97	7	59	31	32	16	11	25.5%	55
Q1/98	9	66	50	44	16	18	55.8%	52

**3) SR 520 E-N Ramp (Fly-over) to NE 8th St. Overpass**

Quarter	Min.	Max	Median	AVG.	SD	Speed (mph) >90%	Percent >45 mph	Number of Data Points
Q4/95	24	63	56	53	9	42	82.9%	20
Q1/96	40	64	54	52	6	41	85.4%	27
Q2/96	25	65	60	59	7	56	96.2%	33
Q3/96	No Data	No Data	No Data	No Data	No Data	No Data	No Data	No Data
Q4/96	36	57	51	49	7	38	73.9%	14
Q1/97	27	60	53	50	9	34	87.2%	24
Q2/97 & Q3/97	No Data Collected							
Q4/97	21	63	51	47	11	29	68.4%	57
Q1/98	31	64	56	55	7	45	92.3%	52

**NORTH I-405 CORRIDOR, P.M. SOUTHBOUND**

**4) Pedestrian Overpass @ SR 908 (NE 85th St.) to SR 520 E-N Ramp (Fly-over)**

Quarter	Min.	Max	Median	AVG.	SD	Speed (mph) >90%	Percent >45 mph	Number of Data Points
Q4/95	53	63	59	58	3	56	100.0%	20
Q1/96	47	61	58	57	4	53	100.0%	27
Q2/96	52	65	61	61	3	57	100.0%	33
Q3/96	No Data	No Data	No Data	No Data	No Data	No Data	No Data	No Data
Q4/96	49	69	56	58	6	53	100.0%	14
Q1/97	44	60	56	55	5	46	91.2%	24
Q2/97 & Q3/97	No Data Collected							
Q4/97	31	63	59	57	6	50	93.1%	58
Q1/98	54	64	61	60	2	57	100.0%	53

**5) NE 124th St. Overpass to Pedestrian Overpass @ SR 908 (NE 85th St.)**

Quarter	Min.	Max	Median	AVG.	SD	Speed (mph) >90%	Percent >45 mph	Number of Data Points
Q4/95	51	60	59	58	3	55	100.0%	20
Q1/96	52	60	57	57	2	55	100.0%	27
Q2/96	55	65	61	61	2	59	100.0%	33
Q3/96	No Data	No Data	No Data	No Data	No Data	No Data	No Data	No Data
Q4/96	54	64	58	58	3	54	100.0%	14
Q1/97	32	60	58	54	8	42	88.9%	24
Q2/97 & Q3/97	No Data Collected							
Q4/97	23	63	59	56	10	53	91.5%	59
Q1/98	52	64	60	60	3	56	100.0%	53

**6) NE 160th St. Overpass (Juanita - Woodinville Way) to NE 124th St. Overpass**

Quarter	Min.	Max	Median	AVG.	SD	Speed (mph) >90%	Percent >45 mph	Number of Data Points
Q4/95	54	65	61	61	3	57	100.0%	20
Q1/96	56	71	60	60	4	57	100.0%	27
Q2/96	59	70	63	64	3	61	100.0%	33
Q3/96	No Data	No Data	No Data	No Data	No Data	No Data	No Data	No Data
Q4/96	55	65	61	61	3	58	100.0%	14
Q1/97	51	68	60	60	3	57	100.0%	24
Q2/97 & Q3/97	No Data Collected							
Q4/97	56	69	62	62	2	60	100.0%	57
Q1/98	57	69	63	64	3	60	100.0%	50

**NORTH I-405 CORRIDOR, A.M. NORTHBOUND**

**1) I-90 Interchange Underpass to SE 8th St. Underpass**

Quarter	Min.	Max	Median	AVG.	SD	Speed (mph) >90%	Percent >45 mph	Number of Data Points
Q4/95	39	63	56	53	7	42	81.3%	33
Q1/96	36	65	54	53	7	46	91.5%	36
Q2/96	37	65	60	56	8	44	89.3%	35
Q3/96	No Data	No Data	No Data	No Data	No Data	No Data	No Data	No Data
Q4/96	41	64	60	57	7	42	86.3%	29
Q1/97	45	67	54	55	6	49	99.7%	29
Q2/97 & Q3/97	No Data Collected							
Q4/97	37	65	56	55	6	46	94.8%	58
Q1/98	31	67	53	53	8	42	83.3%	66

**2) SE 8th St. Underpass to NE 8th St. Overpass**

Quarter	Min.	Max	Median	AVG.	SD	Speed (mph) >90%	Percent >45 mph	Number of Data Points
Q4/95	49	67	56	56	4	52	100.0%	33
Q1/96	24	62	56	55	8	50	94.3%	36
Q2/96	50	63	57	58	3	55	100.0%	35
Q3/96	No Data	No Data	No Data	No Data	No Data	No Data	No Data	No Data
Q4/96	29	63	58	57	6	54	97.2%	29
Q1/97	14	68	56	55	9	53	95.0%	29
Q4/97	50	66	58	58	3	53	100.0%	56
Q1/98	39	65	58	57	5	52	98.5%	67

**3) NE 8th St. Overpass to SR 520 E-N Ramp (Fly-over)**

Quarter	Min.	Max	Median	AVG.	SD	Speed (mph) >90%	Percent >45 mph	Number of Data Points
Q4/95	45	71	56	56	6	48	100.0%	35
Q1/96	18	60	56	55	7	52	96.5%	36
Q2/96	48	65	58	58	3	54	100.0%	35
Q3/96	No Data	No Data	No Data	No Data	No Data	No Data	No Data	No Data
Q4/96	41	60	55	55	4	50	98.1%	29
Q1/97	44	68	55	54	5	46	93.6%	29
Q2/97 & Q3/97	No Data Collected							
Q4/97	40	71	56	56	5	48	96.5%	57
Q1/98	35	64	55	54	6	46	92.5%	67



**NORTH I-405 CORRIDOR, A.M. NORTHBOUND**

**4) SR 520 E-N Ramp (Fly-over) to Pedestrian Overpass @ SR 908 (NE 85th St.)**

Quarter	Min.	Max	Median	AVG.	SD	Speed (mph) >90%	Percent >45 mph	Number of Data Points
Q4/95	25	69	60	59	8	55	95.6%	35
Q1/96	55	67	59	60	3	56	100.0%	36
Q2/96	57	65	61	61	2	59	100.0%	35
Q3/96	No Data	No Data	No Data	No Data	No Data	No Data	No Data	No Data
Q4/96	55	62	60	60	2	59	100.0%	29
Q1/97	54	64	57	59	4	54	100.0%	29
Q2/97 & Q3/97	No Data Collected							
Q4/97	56	66	62	61	2	57	100.0%	57
Q1/98	33	66	62	61	5	59	97.0%	67

**5) Pedestrian Overpass @ SR 908 (NE 85th St.) to NE 124th St. Overpass**

Quarter	Min.	Max	Median	AVG.	SD	Speed (mph) >90%	Percent >45 mph	Number of Data Points
Q4/95	21	74	61	59	10	56	94.7%	35
Q1/96	56	63	60	60	2	57	100.0%	36
Q2/96	55	72	62	62	2	60	100.0%	35
Q3/96	No Data	No Data	No Data	No Data	No Data	No Data	No Data	No Data
Q4/96	54	64	59	59	3	55	100.0%	29
Q1/97	50	63	56	58	3	55	100.0%	29
Q2/97 & Q3/97	No Data Collected							
Q4/97	52	65	61	61	2	58	100.0%	60
Q1/98	56	65	62	61	2	58	100.0%	66

**6) NE 124th St. Overpass to NE 160th St. Overpass (Juanita - Woodinville Way)**

Quarter	Min.	Max	Median	AVG.	SD	Speed (mph) >90%	Percent >45 mph	Number of Data Points
Q4/95	27	68	61	58	9	55	92.5%	35
Q1/96	54	64	59	59	3	55	100.0%	31
Q2/96	55	65	62	62	2	59	100.0%	34
Q3/96	No Data	No Data	No Data	No Data	No Data	No Data	No Data	No Data
Q4/96	43	67	60	60	4	57	99.4%	29
Q1/97	42	63	57	57	4	53	98.2%	29
Q2/97 & Q3/97	No Data Collected							
Q4/97	56	67	62	62	2	60	100.0%	61
Q1/98	35	67	62	61	5	58	95.4%	65

**NORTH I-405 CORRIDOR, P.M. NORTHBOUND**

**1) I-90 Interchange Underpass to SE 8th St. Underpass**

Quarter	Min.	Max	Median	AVG.	SD	Speed (mph) >90%	Percent >45 mph	Number of Data Points
Q4/95	44	63	58	57	5	49	98.5%	23
Q1/96	28	60	57	55	8	53	93.7%	28
Q2/96	53	64	60	60	3	56	100.0%	35
Q3/96	No Data	No Data	No Data	No Data	No Data	No Data	No Data	No Data
Q4/96	43	60	55	55	5	49	97.2%	15
Q1/97	42	67	58	57	5	53	98.1%	25
Q2/97 & Q3/97	No Data Collected							
Q4/97	53	63	60	60	2	57	100.0%	56
Q1/98	29	65	60	59	5	55	98.1%	54

**2) SE 8th St. Underpass to NE 8th St. Overpass**

Quarter	Min.	Max	Median	AVG.	SD	Speed (mph) >90%	Percent >45 mph	Number of Data Points
Q4/95	9	61	56	51	13	33	81.2%	23
Q1/96	21	64	55	50	11	33	74.2%	29
Q2/96	38	66	59	58	5	53	97.5%	35
Q3/96	No Data	No Data	No Data	No Data	No Data	No Data	No Data	No Data
Q4/96	34	56	48	47	8	36	72.3%	15
Q1/97	29	60	55	54	6	49	96.4%	25
Q2/97 & Q3/97	No Data Collected							
Q4/97	12	64	56	52	12	34	84.7%	59
Q1/98	30	63	58	55	8	39	87.0%	54

**3) NE 8th St. Overpass to SR 520 E-N Ramp (Fly-over)**

Quarter	Min.	Max	Median	AVG.	SD	Speed (mph) >90%	Percent >45 mph	Number of Data Points
Q4/95	18	59	51	50	8	43	86.4%	23
Q1/96	28	59	51	48	8	38	71.5%	29
Q2/96	50	60	57	56	3	51	100.0%	35
Q3/96	No Data	No Data	No Data	No Data	No Data	No Data	No Data	No Data
Q4/96	12	56	44	43	11	30	45.9%	15
Q1/97	41	59	52	51	5	44	87.3%	24
Q2/97 & Q3/97	No Data Collected							
Q4/97	24	60	50	48	9	36	65.6%	61
Q1/98	30	64	52	50	8	36	74.1%	54

**NORTH I-405 CORRIDOR, P.M. NORTHBOUND**

**4) SR 520 E-N Ramp (Fly-over) to Pedestrian Overpass @ SR 908 (NE 85th St.)**

Quarter	Min.	Max	Median	AVG.	SD	Speed (mph) >90%	Percent >45 mph	Number of Data Points
Q4/95	18	66	56	53	12	34	83.7%	23
Q1/96	38	63	57	55	7	43	88.1%	29
Q2/96	21	65	59	56	9	43	86.8%	35
Q3/96	No Data	No Data	No Data	No Data	No Data	No Data	No Data	No Data
Q4/96	18	62	51	46	14	22	65.8%	16
Q1/97	32	62	59	56	7	55	93.3%	24
Q2/97 & Q3/97	No Data Collected							
Q4/97	26	66	59	55	10	39	83.3%	60
Q1/98	25	65	60	57	8	46	92.5%	53

**5) Pedestrian Overpass @ SR 908 (NE 85th St.) to NE 124th St. Overpass**

Quarter	Min.	Max	Median	AVG.	SD	Speed (mph) >90%	Percent >45 mph	Number of Data Points
Q4/95	29	64	56	50	12	33	69.7%	23
Q1/96	26	62	54	49	10	34	64.3%	29
Q2/96	23	66	54	51	10	37	71.6%	35
Q3/96	No Data	No Data	No Data	No Data	No Data	No Data	No Data	No Data
Q4/96	11	63	45	43	15	25	53.5%	16
Q1/97	35	65	59	56	7	45	90.2%	24
Q2/97 & Q3/97	No Data Collected							
Q4/97	26	65	52	49	11	31	63.3%	60
Q1/98	24	62	57	52	10	35	73.1%	52

**6) NE 124th St. Overpass to NE 160th St. Overpass (Juanita - Woodinville Way)**

Quarter	Min.	Max	Median	AVG.	SD	Speed (mph) >90%	Percent >45 mph	Number of Data Points
Q4/95	23	60	50	45	13	25	56.2%	23
Q1/96	24	60	53	49	10	33	71.7%	28
Q2/96	22	63	56	51	12	31	70.6%	35
Q3/96	No Data	No Data	No Data	No Data	No Data	No Data	No Data	No Data
Q4/96	19	62	44	44	14	23	45.3%	16
Q1/97	24	64	55	50	12	32	65.2%	24
Q2/97 & Q3/97	No Data Collected							
Q4/97	31	65	50	48	11	33	61.0%	59
Q1/98	24	64	58	51	11	35	69.2%	52

# Travel Time Sections SR-167

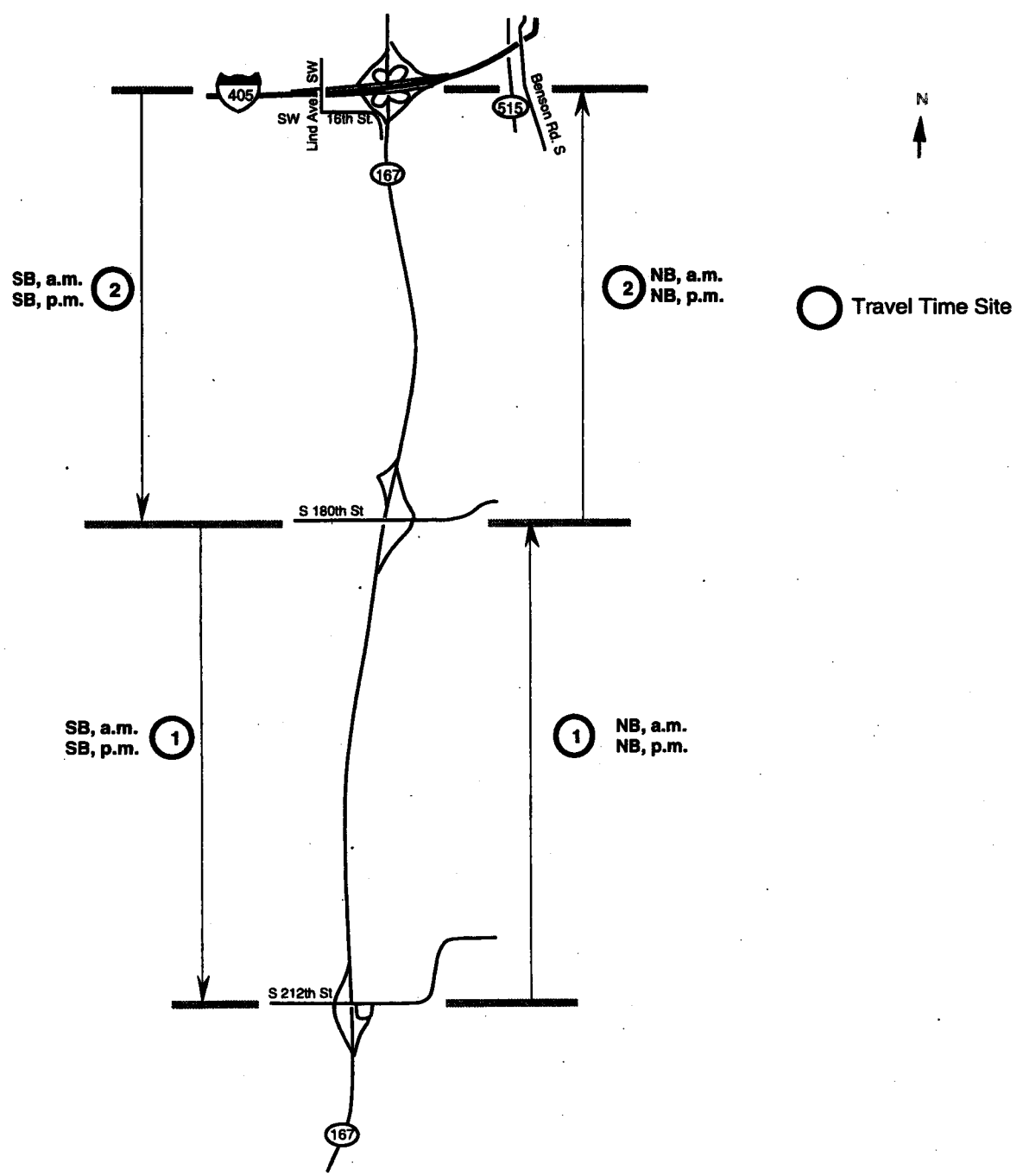

**SR-167 CORRIDOR, A.M. SOUTHBOUND**

**1) S 180th St. Overpass to S 212th St. Overpass**

Quarter	Min.	Max	Median	AVG.	SD	Speed (mph) >90%	Percent >45 mph	Number of Data Points
Q4/95	52	71	61	61	3	58	100.0%	38
Q1/96	52	67	57	58	4	53	100.0%	40
Q2/96	61	66	62	63	1	61	100.0%	28
Q3/96	No Data	No Data	No Data	No Data	No Data	No Data	No Data	No Data
Q4/96	47	67	62	60	4	55	100.0%	22
Q1/97	56	62	59	59	2	57	100.0%	18
Q2/97 & Q3/97	No Data Collected							
Q4/97	54	67	62	62	2	60	100.0%	82
Q1/98	51	66	61	61	2	60	100.0%	59

**2) I-405 Interchange to S 180th St. Overpass**

Quarter	Min.	Max	Median	AVG.	SD	Speed (mph) >90%	Percent >45 mph	Number of Data Points
Q4/95	44	71	57	56	4	53	97.3%	38
Q1/96	50	60	56	56	2	53	100.0%	40
Q2/96	55	64	59	59	2	56	100.0%	28
Q3/96	No Data	No Data	No Data	No Data	No Data	No Data	No Data	No Data
Q4/96	47	65	55	56	4	53	100.0%	22
Q1/97	52	68	55	56	3	53	100.0%	18
Q2/97 & Q3/97	No Data Collected							
Q4/97	51	65	56	57	3	54	100.0%	81
Q1/98	47	67	56	57	4	52	100.0%	59

<b>SR-167 CORRIDOR, P.M. SOUTHBOUND</b>
---

**1) S 180th St. Overpass to S 212th St. Overpass**

Quarter	Min.	Max	Median	AVG.	SD	Speed (mph) >90%	Percent >45 mph	Number of Data Points
Q4/95	37	64	61	59	5	54	98.2%	30
Q1/96	44	62	57	57	3	53	99.7%	35
Q2/96	23	66	61	57	11	37	87.8%	39
Q3/96	No Data	No Data	No Data	No Data	No Data	No Data	No Data	No Data
Q4/96	35	61	54	53	7	41	86.4%	28
Q1/97	45	63	61	58	6	49	100.0%	25
Q2/97 & Q3/97	No Data Collected							
Q4/97	23	66	61	58	8	46	92.1%	126
Q1/98	36	64	62	58	7	46	94.2%	69

**2) I-405 Interchange to S 180th St. Overpass**

Quarter	Min.	Max	Median	AVG.	SD	Speed (mph) >90%	Percent >45 mph	Number of Data Points
Q4/95	53	68	57	57	3	55	100.0%	30
Q1/96	36	61	53	51	6	43	83.9%	35
Q2/96	42	68	57	57	5	51	97.4%	39
Q3/96	No Data	No Data	No Data	No Data	No Data	No Data	No Data	No Data
Q4/96	50	64	54	54	3	50	100.0%	28
Q1/97	46	59	56	55	3	53	100.0%	25
Q2/97 & Q3/97	No Data Collected							
Q4/97	35	68	55	55	5	51	92.1%	126
Q1/98	37	67	56	56	4	51	98.5%	68

**SR-167 CORRIDOR, A.M. NORTHBOUND**

**1) S 212th St. Overpass to S 180th St. Overpass**

Quarter	Min.	Max	Median	AVG.	SD	Speed (mph) >90%	Percent >45 mph	Number of Data Points
Q4/95	52	75	60	61	4	59	100.0%	38
Q1/96	51	64	58	59	3	56	100.0%	40
Q2/96	61	66	62	63	2	62	100.0%	29
Q3/96	No Data	No Data	No Data	No Data	No Data	No Data	No Data	No Data
Q4/96	53	66	62	61	3	57	100.0%	19
Q1/97	57	61	59	59	1	57	100.0%	18
Q2/97 & Q3/97	No Data Collected							
Q4/97	49	67	61	61	3	57	100.0%	82
Q1/98	41	66	61	59	5	52	98.2%	57

**2) S 180th St. Overpass to I-405 Interchange**

Quarter	Min.	Max	Median	AVG.	SD	Speed (mph) >90%	Percent >45 mph	Number of Data Points
Q4/95	13	61	50	48	12	30	74.4%	38
Q1/96	33	63	57	56	6	51	94.4%	40
Q2/96	28	68	62	60	7	57	96.7%	29
Q3/96	No Data	No Data	No Data	No Data	No Data	No Data	No Data	No Data
Q4/96	38	65	61	56	8	45	90.2%	19
Q1/97	43	61	56	56	4	53	99.0%	18
Q2/97 & Q3/97	No Data Collected							
Q4/97	21	66	55	52	11	36	76.8%	82
Q1/98	13	65	51	48	13	28	64.9%	57

**SR-167 CORRIDOR, P.M. NORTHBOUND**

**1) S 212th St. Overpass to S 180th St. Overpass**

Quarter	Min.	Max	Median	AVG.	SD	Speed (mph) >90%	Percent >45 mph	Number of Data Points
Q4/95	57	66	62	61	2	58	100.0%	31
Q1/96	55	64	58	58	2	56	100.0%	35
Q2/96	58	65	62	62	2	60	100.0%	38
Q3/96	No Data	No Data	No Data	No Data	No Data	No Data	No Data	No Data
Q4/96	55	62	60	60	2	59	100.0%	28
Q1/97	57	68	62	61	2	58	100.0%	25
Q2/97 & Q3/97	No Data Collected							
Q4/97	56	67	63	62	2	60	100.0%	125
Q1/98	56	64	63	62	2	60	100.0%	69

**2) S 180th St. Overpass to I-405 Interchange**

Quarter	Min.	Max	Median	AVG.	SD	Speed (mph) >90%	Percent >45 mph	Number of Data Points
Q4/95	52	67	61	61	3	58	100.0%	31
Q1/96	18	66	57	54	10	51	91.8%	35
Q2/96	43	64	59	58	5	48	98.2%	38
Q3/96	No Data	No Data	No Data	No Data	No Data	No Data	No Data	No Data
Q4/96	34	66	57	54	8	45	89.9%	28
Q1/97	34	63	60	56	8	44	89.7%	25
Q2/97 & Q3/97	No Data Collected							
Q4/97	16	69	61	59	8	53	96.2%	130
Q1/98	48	64	62	60	4	53	100.0%	70



**APPENDIX G**

**SPEED COMPARISON DATA BETWEEN HOV  
AND GENERAL PURPOSE LANES BY CORRIDOR SEGMENT  
[BASED ON HOVTT (FCM) TRAVEL TIME DATA FROM APPENDIX F]**

## Differences in Average Speed\* Between HOV and GP Lanes by Corridor Segment

### I-5 North (Southbound AM) 1st Quarter 1998

	1	2	3	4	5
HOV Average	52	54	54	58	59
SOV Average	47	47	40	43	53
Speed Differential	6	8	14	15	6

### I-5 North (Northbound AM) 1st Quarter 1998

	1	2	3	4	5
HOV Average	61	62	63	65	61
SOV Average	54	58	57	57	56
Speed Differential	7	4	6	9	5

### I-5 North (Southbound PM) 1st Quarter 1998

	1	2	3	4	5
HOV Average	61	62	62	65	60
SOV Average	No Data	No Data	No Data	No Data	No Data
Speed Differential	No Data	No Data	No Data	No Data	No Data

### I-5 North (Northbound PM) 1st Quarter 1998

	1	2	3	4	5
HOV Average	54	56	60	63	60
SOV Average	No Data	No Data	No Data	No Data	No Data
Speed Differential	No Data	No Data	No Data	No Data	No Data

## Differences in Average Speed\* Between HOV and GP Lanes by Corridor Segment

### I-5 Downtown (Southbound AM) 1st Quarter 1998

	1	2	3	4	5	6	7
HOV Average	61	63	64	61	56	58	58
SOV Average	59	60	61	56	50	58	56
Speed Differential	2	3	2	5	6	0	2

### I-5 Downtown (Northbound AM) 1st Quarter 1998

	1	2	3	4	5	6
HOV Average	57	56	52	49	56	41
SOV Average	51	61	48	42	52	45
Speed Differential	6	-5	5	8	4	-4

### I-5 Downtown (Southbound PM) 1st Quarter 1998

	1	2	3	4	5	6	7
HOV Average	61	62	64	59	57	61	58
SOV Average	No Data	No Data	No Data	No Data	No Data	No Data	No Data
Speed Differential	No Data	No Data	No Data	No Data	No Data	No Data	No Data

### I-5 Downtown (Northbound PM) 1st Quarter 1998

	1	2	3	4	5	6
HOV Average	62	63	62	57	60	44
SOV Average	No Data	No Data	No Data	No Data	No Data	No Data
Speed Differential	No Data	No Data	No Data	No Data	No Data	No Data

## Differences in Average Speed\* Between HOV and GP Lanes by Corridor Segment

### I-5 South (Southbound AM) 1st Quarter 1998

	1	2	3	4	5	6
HOV Average	63	61	62	61	64	62
SOV Average	65	62	62	61	64	61
Speed Differential	-2	-1	1	0	-1	1

### I-5 South (Northbound AM) 1st Quarter 1998

	1	2	3	4	5	6
HOV Average	60	56	55	56	57	58
SOV Average	47	48	50	52	52	60
Speed Differential	13	7	5	4	5	-3

### I-5 South (Southbound PM) 1st Quarter 1998

	1	2	3	4	5	6
HOV Average	61	49	41	42	42	44
SOV Average	No Data	No Data	No Data	No Data	No Data	No Data
Speed Differential	No Data	No Data	No Data	No Data	No Data	No Data

### I-5 South (Northbound PM) 1st Quarter 1998

	1	2	3	4	5	6
HOV Average	64	64	63	64	64	63
SOV Average	No Data	No Data	No Data	No Data	No Data	No Data
Speed Differential	No Data	No Data	No Data	No Data	No Data	No Data

**Differences in Average Speed\* Between HOV and GP Lanes by Corridor Segment**

**SR 520 (Westbound AM) 1st Quarter 1998**

	1	2	3
HOV Average	37	50	48
SOV Average	34	40	45
Speed Differential	3	10	3

**SR 520 (Eastbound AM) 1st Quarter 1998**

	1	2	3
HOV Average	No Data	No Data	No Data
SOV Average	47	49	47
Speed Differential	No Data	No Data	No Data

**SR 520 (Westbound PM) 1st Quarter 1998**

	1	2	3
HOV Average	37	50	52
SOV Average	23	17	14
Speed Differential	13	33	38

**SR 520 (Eastbound PM) 1st Quarter 1998**

	1	2	3
HOV Average	No Data	No Data	No Data
SOV Average	53	57	52
Speed Differential	No Data	No Data	No Data

## Differences in Average Speed\* Between HOV and GP Lanes by Corridor Segment

### I-90 (Westbound AM) 1st Quarter 1998

	1	2	3	4	5	6	7
HOV Average	55	63	61	63	63	63	62
SOV Average	52	58	61	54	58	58	59
Speed Differential	4	5	0	8	4	4	3

### I-90 (Eastbound AM) 1st Quarter 1998

	1	2	3	4	5	6	7
HOV Average	52	57	61	58	61	61	62
SOV Average	55	58	59	58	57	59	58
Speed Differential	-4	-2	2	0	4	2	4

### I-90 (Westbound PM) 1st Quarter 1998

	1	2	3	4	5	6	7
HOV Average	53	57	59	59	60	64	63
SOV Average	56	54	52	53	0	0	0
Speed Differential	-3	3	7	6	60	64	63

### I-90 (Eastbound PM) 1st Quarter 1998

	1	2	3	4	5	6	7
HOV Average	59	63	62	62	61	62	62
SOV Average	57	57	52	54	0	0	0
Speed Differential	3	5	10	8	61	62	62

## Differences in Average Speed\* Between HOV and GP Lanes by Corridor Segment

### I-405 South (Southbound AM) 1st Quarter 1998

	1	2	3	4	5	6
HOV Average	59	61	55	59	57	59
SOV Average	56	60	48	47	54	56
Speed Differential	3	0	7	12	3	3

### I-405 South (Northbound AM) 1st Quarter 1998

	1	2	3	4	5	6
HOV Average	61	61	59	55	50	51
SOV Average	59	57	40	19	12	23
Speed Differential	2	3	19	36	38	28

### I-405 South (Southbound PM) 1st Quarter 1998

	1	2	3	4	5	6
HOV Average	56	61	55	60	56	60
SOV Average	26	49	36	51	39	54
Speed Differential	30	12	19	9	17	6

### I-405 South (Northbound PM) 1st Quarter 1998

	1	2	3	4	5	6
HOV Average	58	61	59	59	59	61
SOV Average	34	50	52	53	50	52
Speed Differential	23	10	7	6	9	9

## Differences in Average Speed\* Between HOV and GP Lanes by Corridor Segment

### I-405 North (Southbound AM) 1st Quarter 1998

	1	2	3	4	5	6
HOV Average	57	56	53	55	47	58
SOV Average	No Data	No Data	No Data	No Data	No Data	No Data
Speed Differential	No Data	No Data	No Data	No Data	No Data	No Data

### I-405 North (Northbound AM) 1st Quarter 1998

	1	2	3	4	5	6
HOV Average	53	57	54	61	61	61
SOV Average	No Data	No Data	No Data	No Data	No Data	No Data
Speed Differential	No Data	No Data	No Data	No Data	No Data	No Data

### I-405 North (Southbound PM) 1st Quarter 1998

	1	2	3	4	5	6
HOV Average	40	44	55	60	60	64
SOV Average	47	32	47	60	58	63
Speed Differential	-7	12	8	1	3	0

### I-405 North (Northbound PM) 1st Quarter 1998

	1	2	3	4	5	6
HOV Average	59	55	50	57	52	51
SOV Average	60	48	44	52	42	25
Speed Differential	-1	8	6	5	11	27



**Differences in Average Speed\* Between HOV and GP Lanes by Corridor Segment**

**SR 167 (Southbound AM) 1st Quarter 1998**

	1	2
HOV Average	61	57
SOV Average	58	52
Speed Differential	3	5

**SR 167 (Northbound AM) 1st Quarter 1998**

	1	2
HOV Average	59	48
SOV Average	47	37
Speed Differential	12	10

**SR 167 (Southbound PM) 1st Quarter 1998**

	1	2
HOV Average	58	56
SOV Average	53	52
Speed Differential	6	4

**SR 167 (Northbound PM) 1st Quarter 1998**

	1	2
HOV Average	62	60
SOV Average	62	38
Speed Differential	1	22

**APPENDIX H**

**OBSERVER COMMENTS DURING TRAVEL TIME DATA SESSIONS**

Below is a sample of observer comments made during license plate matching travel time data collection. Like vehicle occupancy comments, they fall into three categories of data collection, traffic, and weather conditions. Ellipses represent time gaps between comments made by the observer. Because the length of comments is limited by the program used, words are sometimes cut off.

### DATA COLLECTION

1. computer #52 I just found out is 18 minutes faster than #53 which was the other
2. cold, cloudy..... the previous count was lost due to computer malfunction
3. it's not quite daylight yet hard to read plates.....CT COULDNT READ #
4. it's too dark to see anything but busues at this pt.....traffic is very backed up.....the radio said ther is a big wreck up at 405 + 520 - not much traffic here
5. I am too far up and it is too dark to see yet-headlights are impediment also
6. it is very hard to see on this overpass.
7. Hard to see with the big traffic sign in the way...
8. some of thee number keys are wet and not working
9. time to change batteries bacik ijn a moment
10. Head aches too many counts today of TT! Bye!

### TRAFFIC CONDITIONS

1. I'm wet ... traffic is slowed slightly ... no real stoppages
2. there is a stsalled car & a stste patrol car off to the right
3. RAINY AND MISERABLE.....TRAFFIC WAS TERRIBLE GETTING HERE SO WE STARTED WAY LATE...IT STAYED PRETTY TER-  
...RI.....SEE AT ABOUT 6:30 OR SO. ACCIDENTS..
4. cloudy, warm-60 degrees, dry road.....traffic is moving well.....light traffic.....police stopped somebody in the express lane.....traffic is still moving well, below capacity.....another police pulling over somebody in the express lane.....traffic moving well during counting

5. THERE WAS A MAJOR BACKUP ALL DAY AT THIS SITE. IT POURED FOR ABOUT 20 MINUTES.
6. traffic is sluggish. gonna collect some license plates for MH!
7. final tally: two rear-enders, two near misses, 1 frazzled counter

**WEATHER CONDITIONS**

1. COLD/DARK/RAINY
2. FREEZING COLD/WINDY/GETTING DARK
3. sunny but hell cold!
4. SUNNY AND 80F. MINIMUM WAGE WEATHER.
5. I am late and it is wet. This is a bad day for me.....Traffic is stop and go
6. still dark due to daylight saving time last weekend.....heavy traffic heavy traffic, but it is still moving well.....the rain has stopped for some time
7. cloudy, threatening; summer is grand
8. sunny, tantalizing, frenetic, abusive, c.....no problem : YOW! sunshine ... on my shoulder ... makes me happy

**APPENDIX I**

**SAMPLE SURVEY**



## HIGH OCCUPANCY VEHICLE LANE ANALYSIS PUBLIC OPINION SURVEY

The Washington State Department of Transportation and the Washington State Transportation Center at the University of Washington are working together to study the high occupancy vehicle (HOV) lanes, also known as carpool lanes. We would like to understand your driving preferences and your perception of HOV lane use and effectiveness.

Please give this survey to the person in your household who most often uses freeways between the hours of 6:00-9:00 AM and 3:00-6:00 PM in the Puget Sound area. Ask him or her to fill out the survey and return it by mail within one week. We would appreciate your response. No postage is necessary.

Your answers will not be associated with your name. Please feel free to contact either Eldon L. Jacobson at (206) 685-3187 or William Brown at (206) 616-9183 between 8:00 AM and 4:00 PM if you wish to discuss the survey.

---

### Section A: Your Commute Trip

---

1. Indicate your *usual* mode of driving when using area highways between 6:00-9:00 AM and 3:00-6:00 PM.

- |   |  |
|---|--|
| <input type="checkbox"/> Drive alone                              | <input type="checkbox"/> Bus           |
| <input type="checkbox"/> Carpool - you and 1 other person         | <input type="checkbox"/> Bicycle, Walk |
| <input type="checkbox"/> Carpool - you and 2 or more other people | <input type="checkbox"/> Motorcycle    |
| <input type="checkbox"/> Vanpool                                  | <input type="checkbox"/> Other         |

2. Have you ever used HOV lanes while traveling in the Puget Sound area between 6:00-9:00 AM and 3:00-6:00 PM?

YES \_\_\_ No \_\_\_ (If NO, please proceed to Question 3)

How do you use HOV Lanes? Please indicate all that apply.

- |  |  |
|--|--|
| <input type="checkbox"/> on a bus              | <input type="checkbox"/> in a vanpool    |
| <input type="checkbox"/> in a 2-person carpool | <input type="checkbox"/> alone in a car  |
| <input type="checkbox"/> in a 3-person carpool | <input type="checkbox"/> on a motorcycle |

On which freeway do you usually use HOV lanes?

- |   |  |
|---|--|
| <input type="checkbox"/> I-5 north of Seattle | <input type="checkbox"/> I-405 north of I-90 |
| <input type="checkbox"/> I-5 south of Seattle | <input type="checkbox"/> I-405 south of I-90 |
| <input type="checkbox"/> I-90                 | <input type="checkbox"/> SR 16               |
| <input type="checkbox"/> SR 520               | <input type="checkbox"/> SR 167              |

3. Do you ever *not* use the HOV lanes even though you have enough people in your vehicle to qualify for them between 6:00- 9:00 AM and 3:00-6:00 PM?

Yes \_\_\_ No \_\_\_ If yes, why? (check all applicable)

- |  |  |
|--|--|
| <input type="checkbox"/> the HOV lanes are slower than regular lanes | <input type="checkbox"/> all traffic moves fast enough |
| <input type="checkbox"/> too much trouble to change lanes            | <input type="checkbox"/> forget to use the HOV lanes   |
| <input type="checkbox"/> the HOV lanes are not safe                  | <input type="checkbox"/> other _____                   |

**Section B: Your Opinions**

4. Place an "X" by the *three options* that you think would most likely make HOV lanes more attractive for carpooling, vanpooling, or bus riding.

- Wider and safer HOV lanes.
- Construct direct entrance and exit ramps that connect with inside HOV lanes.
- HOV lanes on the outside (right side) of the freeway.
- HOV lanes on the inside (left side) of the freeway.
- Park & ride lots near freeway entrances/exits.
- Better police enforcement of violations.
- Employers' help with paying for part or all of bus passes, vanpooling fares, or parking for carpoolers.
- Increased frequency of bus service.

5. Please indicate the extent to which you agree or disagree with the following statements.

	Agree Strongly	Agree	Neutral	Disagree	Disagree Strongly
a. HOV lanes are a good idea.	—	—	—	—	—
b. Vehicles dart in and out of HOV lanes too often for the lanes to be safe.	—	—	—	—	—
c. HOV lanes help save all commuters a lot of time.	—	—	—	—	—
d. Constructing HOV lanes is unfair to taxpayers who choose to drive alone.	—	—	—	—	—
e. Existing HOV lanes are being adequately used.	—	—	—	—	—
f. HOV lane violators commit a serious traffic violation.	—	—	—	—	—
g. HOV lane violators are common during the commute hours.	—	—	—	—	—
h. Many more people would carpool if the HOV lanes were more widespread.	—	—	—	—	—
i. HOV lanes should be opened to all traffic.	—	—	—	—	—
j. HOV lanes are convenient to use.	—	—	—	—	—
k. HOV lane construction should continue, in general.	—	—	—	—	—
l. HOV lanes should be opened to all traffic during non-commute hours.	—	—	—	—	—
m. The HERO program helps reduce HOV lane violations. [by encouraging commuters to report HOV violators at (206) 764-HERO]	—	—	—	—	—

**Section C: About Yourself (Optional)**

6. Are you  Male  Female
7. What is your age?  under 31  31-40  41-50  51-64  65+
8. What is your highest level of education?
- did not finish high school
  - high school
  - community college or trade school
  - college/university
  - post graduate
9. Including yourself, how many people live in your household? \_\_\_\_\_
10. How many people living in your household are over age 15? \_\_\_\_\_
11. How many people living in your household work outside the home? \_\_\_\_\_
12. How many vehicles (in working order) do you have? \_\_\_\_\_
13. What is the Zip Code of your work place? \_\_\_\_\_ your home? \_\_\_\_\_
14. Which freeways do you frequently use while traveling in the Seattle area between the hours of 6:00-9:00 AM and 3:00-6:00 PM? Please indicate whether you use each freeway for commute trips and/or for other trips.
- | Commute                  | Other                    |                      | Commute                  | Other                    |        |
|--------------------------|--------------------------|----------------------|--------------------------|--------------------------|--------|
| <input type="checkbox"/> | <input type="checkbox"/> | I-5 north of Seattle | <input type="checkbox"/> | <input type="checkbox"/> | SR 520 |
| <input type="checkbox"/> | <input type="checkbox"/> | I-5 south of Seattle | <input type="checkbox"/> | <input type="checkbox"/> | SR 16  |
| <input type="checkbox"/> | <input type="checkbox"/> | I-405 north of I-90  | <input type="checkbox"/> | <input type="checkbox"/> | SR 167 |
| <input type="checkbox"/> | <input type="checkbox"/> | I-405 south of I-90  | <input type="checkbox"/> | <input type="checkbox"/> | SR 410 |
| <input type="checkbox"/> | <input type="checkbox"/> | I-90                 | <input type="checkbox"/> | <input type="checkbox"/> | SR 512 |

15. Are some sections of the HOV system too congested? If so, where?

\_\_\_\_\_

\_\_\_\_\_

\_\_\_\_\_

16. Comments:

\_\_\_\_\_

\_\_\_\_\_

\_\_\_\_\_

\_\_\_\_\_

Thank you for taking the time to complete this survey. When you are finished, please refold the survey form so that the 'University of Washington' address is displayed, secure with tape, and drop it in a mailbox at your convenience. No postage is necessary.



**APPENDIX J**

**COMMENTS OF SURVEY RESPONDENTS**

The following are examples of respondent's written comments. The comments generally fall into four categories; support for HOV lanes, opposition to HOV lanes, solutions to traffic problems, and miscellaneous. Respondents' comments are overwhelmingly in opposition to HOV lane restrictions and further HOV lane construction. Ten representative comments illustrate respondents' input.

1. Keep SOVs out of bus lane, If buses are more frequent, ridership might increase. I favor congestion pricing to discourage SOVs.
2. I think HOV lanes are great and should be added on all major highways. It may take higher gas prices to entice more people to carpool.
3. When I am stuck in traffic and am in a hurry and cars with one person whiz past in the HOV lane it is VERY frustrating. The HOV lanes should be enforced strictly or eliminated. The way it is now scoff-laws use HOV lanes and get places quickly.
4. HOV lanes should be open to all traffic during non-commute hours. (all hours except 6 am to 9 am and 3 pm to 6 pm)
5. All HOV lanes should be the same - 2 or more people. It's confusing when some lanes are signed for 3+ carpools and other are for 2+ carpools.
6. Traffic problems will not be solved until we have some other mass transit besides buses. Having sat on buses stuck in traffic, I know that buses are not the answer.

7. I believe that HOV lanes help relieve congestion, but they should not be the focus of decreasing congestion. A wide variety of approaches are needed: improved bus lines, short run trolleys, expansion of existing rail transport, increasing safety of bicycle routes, and encouraging carpools and vanpools.
8. I think a lot of commuters think the HOV lanes are for speeding. I like the lanes for convenience but it really scares me with the traffic darting back and forth.
9. I often use the HOV lane when I have my small son in the car with me. I am sure to some driving by that it looks like I'm alone. That is why I don't think observation and mailing a ticket is not [sic] a good idea.
10. I am a real estate appraiser and use these freeways to travel to and from appointments. Due to my profession I am not able to use the HOV lanes on a regular basis. It amazes me the number of multiple occupant vehicles that do not use HOV lanes. I would be interested in knowing why they don't.
11. Too many single drivers abuse the carpool lanes in traffic back-ups. There seems to be no penalty for drivers that do this. I think it would be best to either enforce stiff penalties or get rid of the HOV lanes altogether.
12. HOV lanes need to be on the inside of highways. With current configuration, HOV lanes bunch up at all on/off ramps making the normal lanes quicker.
13. Road construction on expansion of HOV lanes is proceeding at an unacceptably slow pace. This is causing unnecessary delays in commutes.

14. Switching carpool lanes from left to right side of freeway at Renton S-curves is a real challenge. I don't feel that this area moves efficiently.
15. The second person of a carpool should be at least old enough to drive a car. Otherwise HOV lanes are not effective in reducing the number of cars on the freeway.
16. Make 2 or more lanes of the freeway system HOV lanes, therefore creating a cause to use the transit system or carpooling. The only way your going to get SOVs off the road is to mandate legislation against them. The sooner the better.
17. State needs to make the violation fine higher - in California it's like \$250 or higher - they don't have people violating like they do here.
18. The reporting procedure for 764-HERO is far too complicated. The license plate should be sufficient. Vehicle location and description of car is not easily to ascertain nor relevant.
19. I would like to see consideration in this survey for those people who do not commute directly to and from work every day, simply to factor in this section of the population, instead of assuming that all people commute directly to and from work.
20. Need to install glare barriers on jersey barrier between adjacent HOV lanes. It's dangerous driving in dark wet conditions looking into the headlights of oncoming cars. Also, drainage is a problem with the HOV lanes between Northgate and Lynnwood. I don't use the carpool lane in such conditions.