

**Draft Technical Report**  
Research Project Agreement No. T9903, Task 84  
Fuzzy Ramp Implementation

**ALGORITHM DESIGN, USER INTERFACE, AND  
OPTIMIZATION PROCEDURE FOR  
A FUZZY LOGIC RAMP METERING ALGORITHM:  
A TRAINING MANUAL FOR FREEWAY OPERATIONS ENGINEERS**

by

Cynthia Taylor  
Research Engineer

Deirdre Meldrum  
Associate Professor

Department of Electrical Engineering  
University of Washington  
Seattle, Washington 98195

**Washington State Transportation Center (TRAC)**  
University of Washington, Box 354802  
University District Building  
1107 NE 45th Street, Suite 535  
Seattle, Washington 98105-4631

Washington State Department of Transportation  
Technical Monitor  
Dave McCormick  
Traffic Systems Manager, Northwest Region

Prepared for

**Washington State Transportation Commission**  
Department of Transportation  
and in cooperation with  
**U.S. Department of Transportation**  
Federal Highway Administration

February 2000

## TECHNICAL REPORT STANDARD TITLE PAGE

1. REPORT NO. <b>WA-RD 481.1</b>	2. GOVERNMENT ACCESSION NO.	3. RECIPIENT'S CATALOG NO.	
4. TITLE AND SUBTITLE <b>Algorithm Design, User Interface, and Optimization Procedure for a Fuzzy Logic Ramp Metering Algorithm: A Training Manual for Freeway Operations Engineers</b>		5. REPORT DATE <b>February 2000</b>	
		6. PERFORMING ORGANIZATION CODE	
7. AUTHOR(S) <b>Cynthia Taylor and Deirdre Meldrum</b>		8. PERFORMING ORGANIZATION REPORT NO.	
9. PERFORMING ORGANIZATION NAME AND ADDRESS <b>Washington State Transportation Center (TRAC) University of Washington, Box 354802 University District Building; 1107 NE 45th Street, Suite 535 Seattle, Washington 98105-4631</b>		10. WORK UNIT NO.	
		11. CONTRACT OR GRANT NO. <b>Agreement T9903, Task 84</b>	
12. SPONSORING AGENCY NAME AND ADDRESS <b>Research Office Washington State Department of Transportation Transportation Building, MS 47370 Olympia, Washington 98504-7370 Dave McCormick, Project Manager, 206-440-4486</b>		13. TYPE OF REPORT AND PERIOD COVERED <b>Training manual</b>	
		14. SPONSORING AGENCY CODE	
15. SUPPLEMENTARY NOTES <b>This study was conducted in cooperation with the U.S. Department of Transportation, Federal Highway Administration.</b>			
16. ABSTRACT <p style="text-align: center;">                     This training manual describes in detail the fuzzy logic ramp metering algorithm implemented system-wide in the greater Seattle area. The method for defining the inputs to the controller and optimizing the performance of the algorithm is explained. Instructions are given for observing and tuning the algorithm through the user interface. Examples of how to solve various problems are also provided.                 </p>			
17. KEY WORDS <b>Fuzzy logic control, intelligent transportation systems, freeway operations</b>		18. DISTRIBUTION STATEMENT <b>No restrictions. This document is available to the public through the National Technical Information Service, Springfield, VA 22616</b>	
19. SECURITY CLASSIF. (of this report) <p style="text-align: center;">None</p>	20. SECURITY CLASSIF. (of this page) <p style="text-align: center;">None</p>	21. NO. OF PAGES	22. PRICE

## **DISCLAIMER**

The contents of this report reflect the views of the authors, who are responsible for the facts and the accuracy of the data presented herein. The contents do not necessarily reflect the official views or policies of the Washington State Transportation Commission, Department of Transportation, or the Federal Highway Administration. This report does not constitute a standard, specification, or regulation

# TABLE OF CONTENTS

<u>Section</u>	<u>Page</u>
<b>INTRODUCTION</b> .....	<b>1</b>
<b>ALGORITHM DESIGN</b> .....	<b>6</b>
Ramp Metering Inputs .....	6
FLC Steps .....	8
Fuzzification .....	8
Rule Evaluation .....	10
Design Changes .....	14
Defuzzification .....	15
HOV Adjustment .....	18
Handling Bad Data .....	19
Control Hierarchy .....	21
<b>ALGORITHM OBSERVATION</b> .....	<b>23</b>
<b>FUZZY EQUATIONS</b> .....	<b>25</b>
Equation Prototype .....	25
Error Checking .....	26
Equation Examples .....	31
Local Input .....	31
Downstream Input .....	38
Upstream Input .....	49
Queue Input .....	49
Advance Queue Input .....	56
HOV Bypass .....	58
<b>TUNING</b> .....	<b>60</b>
Parameters for Tuning .....	60
Procedure for Optimization .....	67
Examples of Tuning .....	74
Compensating for Inaccurate Data .....	74
Compensating for Poor Detector Placement .....	81
Tuning the Ramp Queue .....	85
Tuning the Metering Rate .....	88
Preventing a Secondary Queue .....	91
<b>SUMMARY</b> .....	<b>92</b>
<b>ACKNOWLEDGMENTS</b> .....	<b>93</b>
<b>REFERENCES</b> .....	<b>94</b>
<b>APPENDIX: Complete List of Fuzzy Meter Equations</b> .....	<b>95</b>

## LIST OF FIGURES

<u>Figure</u>		<u>Page</u>
1:	Default Fuzzy Classes for Local and Downstream Occupancy.....	10
2:	Default Fuzzy Classes for Local and Downstream Speed.....	11
3:	Default Fuzzy Class for Queue and Advance Queue Occupancy ....	11
4:	Default Fuzzy Classes for Metering Rates of Single and Multiple Lanes	17
5:	Defuzzification Calculation .....	18
6:	Snapshot of <i>Watch_fuzzymeter</i> .....	23
7:	Local Input for EB NE 8th to NB 405 .....	34
8:	Local Input for Boeing Access Road to NB I-5 .....	35
9:	Local Input for 4 <sup>th</sup> Ave South to SB I-5 .....	37
10:	Bottleneck Input ES-310R for SB SR-167 .....	40
11:	Bottleneck Input ES-314D and ES-317D for SB SR-167 .....	40
12:	Bottleneck Input ES-319D for SB SR-167 .....	41
13:	Breakdown Frequency of ES-310D:_MS_Stn .....	42
14:	Breakdown Frequency of ES-311D:_MS_Stn .....	42
15:	Breakdown Frequency of ES-312D:_MS_Stn .....	43
16:	Breakdown Frequency of ES-314D:_MS_Stn .....	43
17:	Breakdown Frequency of ES-315R:MMS_Stn .....	44
18:	Breakdown Frequency of ES-317D:_MS_Stn .....	44
19:	Breakdown Frequency of ES-319D:_MS_Stn .....	45
20:	Breakdown Frequency of ES-320R:MMS_Stn .....	45
21:	Breakdown Frequency of ES-322D:_MS_Stn .....	46
22:	Breakdown Frequency of ES-324D:_MS_Stn .....	46
23:	Detector Placement of NE 107 <sup>th</sup> St to SB I-5 .....	52
24:	Loop Detector Placement for Northgate to SB I-5 .....	54
25:	Loop Detector Placement for Michigan to NB I-5 .....	54
26:	Loop Detector Placement for Alderwood to NB I-5 .....	56
27:	Crisp and Normalized Fuzzy Classes .....	61
28:	Default and Tuned Fuzzy Classes of Advance Queue Occupancy...	84
29:	Default and Tuned Fuzzy Classes of Queue Occupancy .....	84
30:	Default and Tuned Fuzzy Classes of Meter Rate .....	89

## LIST OF TABLES

<u>Table</u>		<u>Page</u>
1.	Description of Algorithm Inputs.....	6
2.	Rule Base for Fuzzy Ramp Metering Algorithm .....	12
3.	Equation Error Checks Performed in Build RMDB.....	27
4.	Equation Error Checks Performed Upon Start-up.....	30
5.	Fuzzy Metering Parameters .....	64
6.	Control Objectives.....	69
7.	Trouble Shooting Guide .....	75

## INTRODUCTION

Fuzzy logic is a relatively new concept, conceived by Professor Zadeh at U.C. Berkeley (Zadeh, 1965). Fuzzy logic emphasizes qualitative information over quantitative information. Rather than strict truth assignments such as yes/no or on/off, fuzzy logic deals with shades of gray between black and white. Through the application of natural linguistic variables and the heuristics of human reasoning, fuzzy logic can utilize imprecise or incomplete information. Fuzzy logic control (FLC) uses rule-based logic to easily incorporate operator expertise about a system.

The Japanese were the first to realize the potential of FLC in every day applications. Bart Kosko, an expert in FLC, theorizes that the reason for this is that Eastern culture is much more comfortable with the concept of duality, ambiguity, and the complexities of vagueness than is Western culture (Kosko, 1993). The first high-profile application of FLC was a high-speed train in Sendai, which improved the economy, comfort, and precision of the ride (Yasunobu and Miyamoto, 1985). Since then, FLC has been used in a broad spectrum of applications, such as the recognition of hand written symbols in Sony pocket computers, Canon auto-focus cameras, Omron auto-aiming cameras, earthquake prediction at the Institute of Seismology Bureau of Metrology in Japan, Sugeno flight aid for helicopters, Nissan and Subaru car engine control for better efficiency and stability, Mitsubishi and Sharp air-condition control for fewer fluctuations, and simplified robotic control by Hirota, Fuji Electric, Toshiba, and Omron.

FLC has been used for ramp metering in two previous applications. A CALTRANS research group tested FLC to control entry to the San Francisco-Oakland Bay Bridge (Chen and May, 1990). Their ramp metering algorithm performed well in simulation and was implemented on-line. In Holland, an FLC has been tested for on-line ramp metering on the A12 Freeway between The Hague and Utrecht (Taale, Slager, and Rosloot, 1996). Their FLC produced 35 percent faster travel times and a 5 to 6 percent

greater bottleneck capacity than two other controllers for an 11-km freeway section. These FLC algorithms differ considerably from each other and the one presented in this research in that they use different inputs and different control heuristics. The FLC described in this manual uses system-wide information and controls over 100 ramp meters.

The Fuzzy Logic Ramp Metering Algorithm documented in this manual was tested in simulation in a previous project. The algorithm was integrated with FRESIM, a freeway simulation model. Its performance was compared to the other ramp metering algorithms available in FRESIM (Taylor and Meldrum, 1995). For five of the six testing sets, encompassing a variety of traffic conditions, the fuzzy controller outperformed the three other controllers tested. Since then, it has been implemented on-line system-wide at the Transportation Systems Management Center (TSMC) for the Northwest District of Washington State Department of Transportation (WSDOT). The fuzzy logic ramp metering algorithm was evaluated on two corridors by comparing its performance with that of two other ramp metering algorithms, Bottleneck and Local, over a four-month period.

FLC is well-suited for ramp metering for four main reasons. 1) It can utilize incomplete or inaccurate data. 2) It can balance conflicting objectives. 3) It does not require extensive system modeling. 4) It is easy to tune.

1) Loop detector data are often missing or inaccurate because of communication problems, hardware failures, construction, and poor calibration. For this reason, a ramp metering algorithm that does not require perfect data is highly desirable. The Bottleneck algorithm at the Seattle TSMC is limited because it calculates metering rate adjustments directly from raw loop detector volumes. It reduces the number of vehicles entering the freeway by the number of vehicles being stored in a downstream bottleneck section (Jacobson, Henry, and Mehyar, 1988). The effectiveness of this approach is limited by the accuracy of the mainline volume data. The error of these mainline volumes is often higher than the storage rate itself, causing a very poor signal-to-noise ratio for the storage rate data, and in turn, the metering rates. Because the fuzzy logic control preprocesses the data



rather than calculating rates directly from raw data, this design is better suited for imprecise data handling.

2) An inherent difficulty with ramp metering during saturated conditions is that WSDOT has two conflicting objectives: to reduce mainline congestion by restricting metering rates and to reduce ramp queues by increasing metering rates. The Local and Bottleneck algorithms often oscillate between these opposing objectives, for a couple of reasons.

One source of oscillation is that the Local and Bottleneck algorithms use threshold activation, which is either on or off. Thus, these algorithms respond to existing problems rather than preventing them. We know that the main mechanism by which ramp metering provides system-wide benefit is by preventing or delaying mainline congestion, and that once a bottleneck has formed, returning to free-flow conditions is difficult. Likewise, preventing excessive ramp queues is important because it is difficult to dissipate an excessive ramp queue without causing mainline congestion. Therefore, it is important that the algorithm prevent downstream bottlenecks, mainline congestion, and excessive ramp queues. The fuzzy logic controller eliminates the time lag between problem detection and corrective action because it considers the entire range of input data. Rather than on or off, it provides various degrees of activation for smoother, faster, and more preventative control.

Another source of oscillation in the Local and Bottleneck algorithms is that a series of adjustments are made to the metering rate rather than considering all factors simultaneously. In this manner, the metering rate can drift from the main objectives. For example, the HOV (high occupancy vehicle) adjustment used in both the Local and Bottleneck algorithms often dominates the metering rate. It further restricts the metering rate by the number of carpool bypasses and violators (the difference between the passage rates and previous metering rates). This HOV adjustment frequently pushes the rate to the minimum, overriding all other factors. These restrictive rates produce longer ramp queues,

which in turn compel more drivers to violate the metering, resulting in a vicious cycle of minimum rates. These algorithms jump as well as drift between objectives: the Bottleneck algorithm chooses the minimum rate between the Local and Bottleneck rates. Although always using the minimum calculated rate is helpful for mainline congestion, it can be detrimental to flow and ramp delay. Alternatively, the Fuzzy Logic Ramp Metering Algorithm produces smoother transitions and keeps sight of the big picture because it balances several performance objectives simultaneously: to mitigate downstream bottlenecks, to reduce local congestion, and to maintain acceptable ramp queues.

3) Another reason that FLC is appropriate to ramp metering is that it does not require extensive system modeling. Instead, control parameters are tuned to optimize the performance criteria. This technique is suitable for ramp metering because freeway systems are difficult to model accurately, being nonlinear (abrupt traffic transitions in space and time), chaotic (a small event has a huge effect), and nonstationary (subject to change over time). Many algorithms are overly dependent on the accuracy of the system model, such as those that assume a constant freeway capacity for a given location (Masher, Ross, Wong, Tuan, Zeidler, and Petracek, 1975.) However, freeway capacity can change with conditions, such as poor weather. For control purposes, it is not the volume itself that is of interest, but how much demand exceeds capacity. By using congestion indicators as our inputs to the ramp metering algorithm, we have indirectly taken into account weather, incidents, special events, and construction. Using these inputs, the algorithm can expertly handle poor data, incidents, special events, and bad weather without modifying the control parameters. This robustness makes operation much easier because most ramps can use system-wide defaults, with little to no tuning required for implementation and maintenance.

4) The ability to tune the ramp metering algorithm easily is valuable because performance objectives are not uniform. In some areas, local politics may dictate shorter ramp queues. Traffic patterns change with construction, urban growth, and seasons, which may result in a new relative weighting of performance objectives. The Local and

Bottleneck algorithms are difficult to tune because it is hard for an operator to follow the series of adjustments made to the metering rate, many of them internal to the 170 microprocessor. The Bottleneck algorithm always meters at the minimum rate, except when queue override adjustments occur. The reason for this is that it calculates the metering rate from the maximum downstream storage rate. Storage rates rapidly oscillate around zero, regardless of congestion levels, with no change in amplitude between free flow and heavy congestion. Consequently, the Bottleneck algorithm is particularly difficult to tune to achieve the desired objective. On the other hand, the Fuzzy Logic Ramp Metering Algorithm was designed for easy tuning. With natural linguistic variables and rule-based logic that mimics the way an operator thinks about ramp metering, the algorithm is much easier to understand. Consequently, the operator can intuitively adjust the control to achieve the desired performance.

This document contains information for freeway operations engineers who implement, operate, and tune the fuzzy logic ramp metering algorithm. The algorithm design is described in detail. Instructions are given for observing the algorithm operation through *watch\_fuzzymeter*. The procedure for optimizing the algorithm's performance is described. This manual contains numerous examples of implementation and tuning, which explain how to handle a wide variety of situations. For details on the code itself, see "A Programmer's Guide to the Fuzzy Logic Ramp Metering Algorithm: Software Design, Integration, Testing, and Evaluation" (Taylor and Meldrum, 2000.) For the results of the on-line testing and methods of performance evaluation, see "Evaluation of a Fuzzy Logic Ramp Metering Algorithm: A Comparative Study Between Three Ramp Metering Algorithms used in the Greater Seattle Area" (Taylor and Meldrum, 2000.)

## ALGORITHM DESIGN

### *Ramp Metering Inputs*

The inputs to the ramp metering algorithm are calculated from loop detector data sent from 170 microprocessors to a central VAX computer every 20 seconds. Each metered lane has its own fuzzy logic controller, which determines a new metering rate every 20-seconds. For each metered lane, there are eight inputs to the ramp metering algorithm (Table 1).

**Table 1. Description of Algorithm Inputs**

<b>Input</b>	<b>Typical Detector Locations</b>	<b># of Samples</b>
Local Occupancy	Mainline station just upstream of merge	3
Local Speed	Same as for Local Occupancy	3
Upstream Occupancy	Next upstream mainline station	3
Downstream Occupancy	Multiple downstream stations	3
Downstream Speed	Same as for Downstream Occupancy	3
Queue Occupancy	Queue detector on the ramp	variable
Advance Queue Occupancy	Tail end of the available queue storage	variable
HOV Volume	HOV bypass passage loop	6

The mainline inputs use 1-minute data calculated from the previous three samples. One-minute data smooth the sharp oscillations of 20-second data, while still providing a quick response. The local mainline occupancy and local mainline speed inputs are calculated from a station composed of adjacent mainline loop detectors located just upstream of the on-ramp merge. The speed is estimated from the following equation,

where  $g$  is assumed to be a constant factor to convert from density to occupancy. (See Compensating for Inaccurate Data for further a description of this variable.)

$$Speed = \frac{Volume}{Occupancy * g}$$

The upstream occupancy is only used when the local occupancy input is unusable because of an absence of good data for that station over the previous minute. In this situation, the upstream detector substitutes for the local detector until good local data resume.

The downstream occupancy is the maximum occupancy of specified downstream stations, and the downstream speed input is the one associated with the maximum downstream occupancy. Thus, the detectors used to calculate the downstream occupancy and speed may vary from one sample to the next. The stations to use for this downstream input are determined by examining historical frequency of breakdown on the mainline. Origin-destination and incident handling are also taken into account for deciding which ramp meters could mitigate which bottlenecks. The Downstream Input section explains how to determine the stations to use for this input.

The number of samples for the ramp inputs can be specified for each location. The reason for this flexibility is to adjust for local variations. There is a need for this degree of flexibility because detector placement varies from one ramp to the next, and ramp metering algorithms are sensitive to the placement of queue detectors. For detectors that are properly placed with respect to ramp storage, ramp demand, and arterial signals, 40-second data are used for the ramp inputs. If detectors are poorly placed, control parameters can be tuned to compensate for this problem. (See Compensating for Poor Detector Placement.)

The queue occupancy input is from a detector typically located halfway between the ramp metering stop bar and the end of the ramp storage, although this varies considerably from ramp to ramp. The advance queue occupancy is from a detector that is usually located at the end of the ramp storage. Several ramps have two adjacent metered

lanes, where vehicles in the ramp queue can weave between the lanes. In the case where adjacent lanes share the demand, the queue occupancies for lanes 1 and 2 are typically averaged together to produce the same metering rate for each lane. Likewise, if multiple advance queue detectors are available (such as at the right hand turns and left hand turns on the arterial), the advance queue occupancies are typically averaged together.

The HOV adjustment is made after the fuzzy logic controller calculates a metering rate. Two-minute data are used to calculate the HOV adjustment (in vehicles/minute) because HOV passage volume tends to be very oscillatory. By smoothing this input over six samples, we smooth the metering rate, dissipating the metering rate reduction over a longer time frame.

### ***FLC Steps***

In general, fuzzy logic control involves three main steps: 1) *fuzzification* to convert the quantitative inputs into natural language variables, 2) *rule evaluation* to implement the control heuristics, and 3) *defuzzification* to map the qualitative rule outcomes to a numerical output.

### **Fuzzification**

The first step in the FLC is fuzzification, which preprocesses the inputs to the controller. Fuzzification translates each numerical input into a set of fuzzy classes, also known as linguistic variables. For the local occupancy and local speed, the fuzzy classes used are very small (VS), small (S), medium (M), big (B), and very big (VB). The degree of activation indicates how true that class is on a scale of 0 to 1. The *trueness* of each class can also be thought of as a degree of likelihood or probability, as fuzzy logic is based on Bayesian set theory. Figures 1 through 4 represent the fuzzy classes when the system-wide parameter defaults are used.

For example, if the local occupancy were 20.0 percent, the M class would be true to a degree of 0.2, and the B class would be true to a degree of 0.7, while the remaining classes would be zero (top of Figure 1). If the local occupancy input were less than 11.0 percent, the VS class would be true to a degree of 1.0, and the remaining classes would be zero. If the occupancy input were greater than 25.0 percent, then the VB class would be true to a degree of 1.0, and the remaining classes would be zero. Thus, the local occupancy input is active for at least one class at all times. Between 11.0 percent and 25.0 percent, the controller response is dynamic. Outside of this dynamic range, this input still activates a control response, but behavior is static. The downstream occupancy only uses the VB class, but it begins activating at 11.0 percent and reaches full activation at 25.0 percent (bottom of Figure 1).

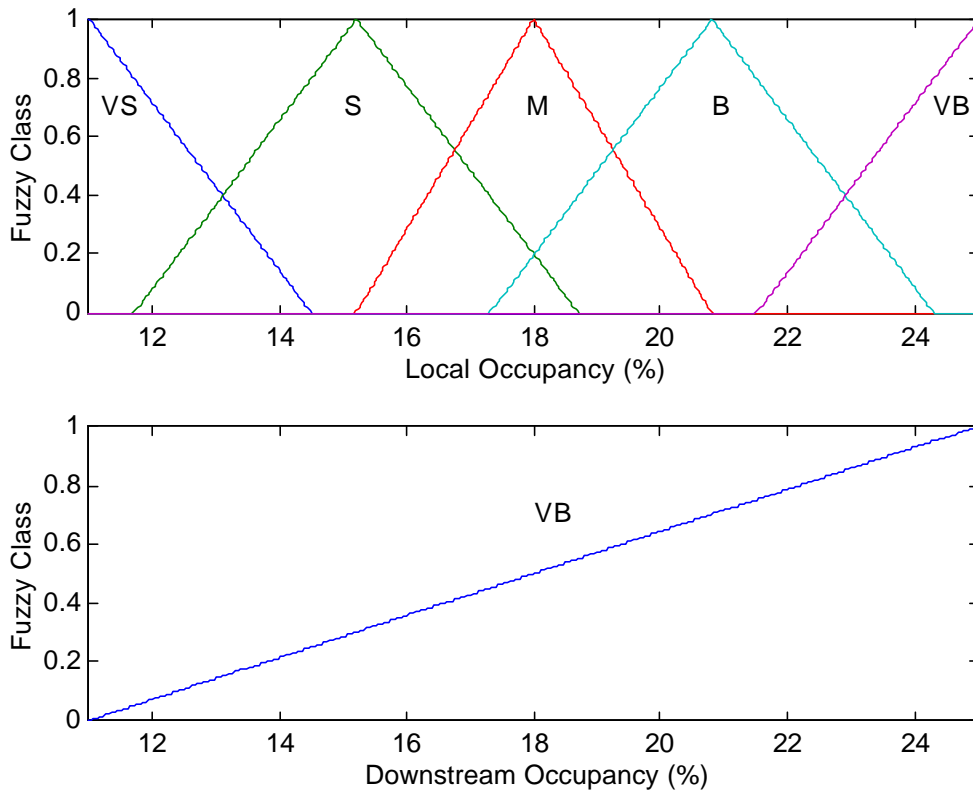
The local speed uses all five fuzzy classes (top of Figure 2). The dynamic range of this input is between 64.6 kph (40.0 mph) and 88.5 kph (55.0 mph). The downstream speed (bottom of Figure 2) uses only the VS class, which starts activating at 88.5 kph (55 mph) and fully activates at 64.4 kph (40 mph) and below.

The queue occupancy and advance queue occupancy inputs use the VB class. For ramps with adequate placement of ramp detectors, the parameter defaults for both of the inputs begin activation at 12.0 percent, and reach full activation at 30.0 percent. The fuzzy class for advance queue occupancy looks identical to that shown for queue occupancy in Figure 3.

For each input at each location, the dynamic range, distribution, and shape of these fuzzy classes can be tuned. In other words, one way of modifying the behavior of the controller is to redefine our linguistic variables. This is particularly useful when the data do not accurately represent the conditions that we would like them to measure. (For examples on how to tune the fuzzy classes, see the TUNING section).

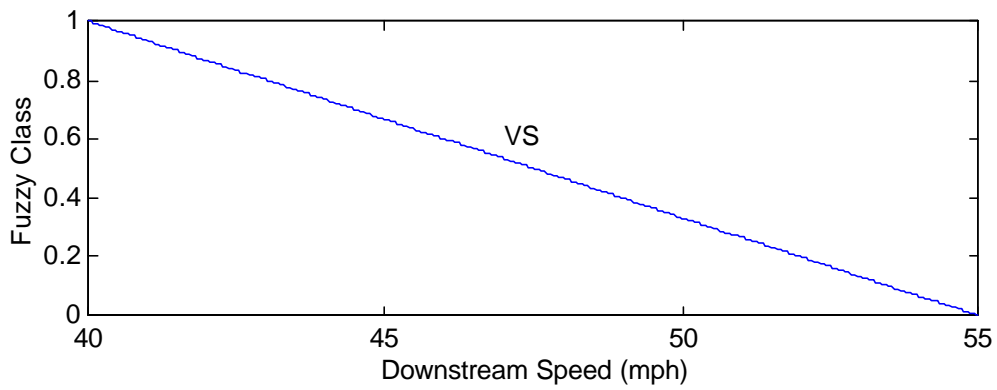
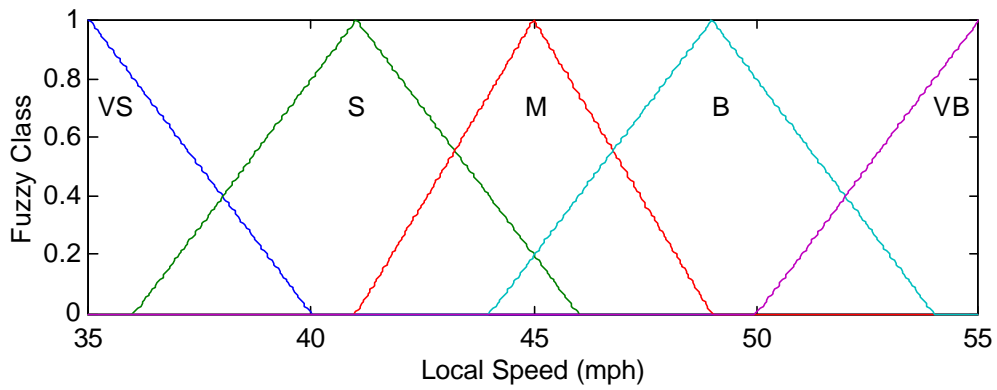
## Rule Evaluation

After fuzzification, the rule base is evaluated. The rule base is the heart of the controller, incorporating the control strategy. The rules are a set of if-then statements similar to the heuristics an operator would use to control the system (Table 2). For a given premise, a fuzzy class of metering rate is specified, either VS, S, M, B, or VB. Within the TSMC VAX, metering rates are in units of vehicles/minute (as opposed to headway). Thus, a VS metering rate is a more restrictive metering rate. The rule outcome is equal to the degree of activation of the rule premise. Each rule has a weighting that reflects its relative importance within the rule base. By adjusting these rule weights, the operator can balance the performance objectives.

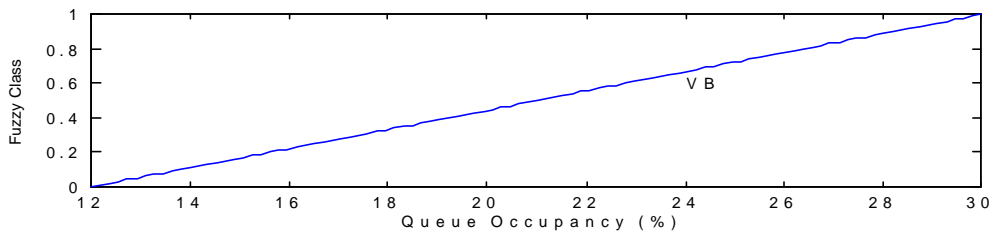


**Figure 1: Default Fuzzy Classes for Local and Downstream Occupancy**





**Figure 2: Default Fuzzy Classes for Local and Downstream Speed**



**Figure 3: Default Fuzzy Class for Queue and Advance Queue Occupancy**

**Table 2. Rule Base for Fuzzy Ramp Metering Algorithm**

<b>Rule</b>	<b>Default Rule Weight</b>	<b>Rule Premise</b>	<b>Rule Outcome</b>
1	2.5	If local occupancy is VB	Metering Rate is VS
2	1.0	If local occupancy is B	Metering Rate is S
3	1.0	If local occupancy is M	Metering Rate is M
4	1.0	If local occupancy is S	Metering Rate is B
5	1.0	If local occupancy is VS	Metering Rate is VB
6	3.0	If local speed is VS AND local occupancy is VB	Metering Rate is VS
7	1.0	If local speed is S	Metering Rate is S
8	1.0	If local speed is B	Metering Rate is B
9	1.0	If local speed is VB AND local occupancy is VS	Metering Rate is VB
10	4.0	If downstream speed is VS AND downstream occupancy is VB	Metering Rate is VS
11	2.0	If queue occupancy is VB	Metering Rate is VB
12	4.0	If advance queue occupancy is VB	Metering Rate is VB

Rules 1 through 5 specify a fuzzy metering class given the local mainline occupancy. These rules are similar to the heuristics of the Local Metering Algorithm. While all other rules have a minimum rule weight of zero, these local rules have a minimum rule weight of 0.1 (the software checks for this). The reason for barring non-zero local rule weights is to prevent the possibility of no rules activating within the rule base. The result of no active rules would be undefined, so the controller is not permitted to operate in that input space.

Rules 6-9 use the relationship between local speed and local occupancy for a more specific congestion index. Rules 6 and 10 use the AND operator between two premises.

The intersection of these two conditions is implemented as the minimum of the membership degrees, which becomes the rule outcome.

Notice that Rules 1 and 6 have relatively higher weightings. The reason for this is to restrict the metering rate when the vehicles are unable to merge onto the mainline. When the mainline is highly congested, a secondary queue of metered vehicles may form. If a secondary queue persists, ramp metering is no longer providing any benefit. To maximize system-wide benefit in the event of a highly congested merge, the vehicles are typically better off stored on the ramp than at the merge. Otherwise, a mainline bottleneck will form as a result of the merge, delaying all drivers through that section. This is a special case in which a ramp queue that exceeds the available ramp storage is acceptable, provided that no safety hazards or predominate politics are caused by the excessive ramp queue. Although the TSMC has not positioned detectors to directly sense the secondary queue, additional detectors are not necessary because a very big local mainline occupancy and a very small local mainline speed correlates well with secondary queue formation. In this situation, the fuzzy logic ramp metering algorithm typically meters just low enough to prevent secondary queue formation.

The objective of rule 10 is to prevent or delay downstream bottleneck formation. When congestion begins to form downstream, a more restrictive metering rate is desirable. The high weighting of this rule reflects that this is the primary way in which ramp metering benefits mainline efficiency.

Rules 11 and 12 are designed to prevent excessive queue formation. These rule weights are tuned to achieve the desired balance between alleviating mainline congestion (rules 1-10) and maintaining the desired queue (rules 11 and 12). Depending on local politics, peak ramp demand, available ramp storage, and in particular, the placement of the detectors, these rule weights may be adjusted for local conditions. For most ramps, the advance queue detector is located near the end of the ramp storage, in which case a strong weighting for rule 12 will prevent vehicles from blocking the arterial.

## **Design Changes**

On a side note, the original design contained more rules than those in Table 2 with the idea that it is easier to delete rules than it is to add new rules. During on-line testing, we determined which rules were unnecessary and effectively eliminated them by setting their weights to zero. The original rule base contained three rules that utilized an upstream input. The concept was to smooth the rapid oscillations of mainline volumes. By fitting more vehicles between platoons, a higher overall flow could be achieved during lighter congestion. During moderate to light flow, the upstream detector provided an adequate short-term prediction of congestion. These upstream rules were the following:

- If upstream occupancy is medium, metering rate is medium.
- If upstream occupancy is small, metering rate is big.
- If upstream occupancy is very small, metering rate is very big.

Through on-line testing, we found that although it was possible to increase the flow using the upstream detector, this benefit was local and short-lived. For most corridors, these additional vehicles eventually ended up contributing to a downstream bottleneck. Because preventing the downstream bottleneck is far more important in terms of system-wide benefit than fitting more vehicles between platoons, the controller performance was better without these upstream rules.

The other rules that were in the original design but not in the final product are two additional downstream bottleneck rules:

- If downstream speed is S and downstream occupancy is B, metering rate is S.
- If downstream speed is M and downstream occupancy is M, metering rate is M.

At the time these additional rules were in use, the downstream inputs used five fuzzy classes distributed like the local occupancy (top of Figure 1) and local speed (top of Figure 2), rather than just the VB downstream occupancy class (bottom of Figure 1) and VS downstream speed (bottom of Figure 2). Basically, we had to choose between two methods: 1) Use multiple downstream rules that produce different metering rate classes for

different input classes, or 2) Use only one downstream rule with one class for each downstream input and one resulting metering rate class (Rule 10 of Table 2).

Although each method has its advantages, we found that method 2 was superior overall. The problem with the original method was that these additional rules sometimes produced a less restrictive final metering class than was desired because the downstream rule outcome was offset by the other rule outcomes. The concern with the second method was that it would not be able to produce a final M or B rate when desired. However, it turned out that this was no problem. Whenever a downstream bottleneck is forming, the resulting restrictive metering class of Rule 10 is balanced by queue conditions and local conditions. The other rules pull the metering rate back toward the other end of the spectrum when desired. Although Rule 10 by itself can only produce the VS metering rate class, the centroid between rules is able to produce the entire range of metering rates under the appropriate conditions. Thus, regardless of whether the downstream bottleneck formation is moderate or very big, we always want the control response of the downstream rule (not necessarily the overall response) to be the VS metering class, with varying degrees of activation. To achieve various degrees of activation over the original input range, the VB class for the downstream occupancy was expanded to begin at 11 percent and higher. Likewise, the VS class for the downstream speed was expanded to begin activation at 88.5 kpm (55.0 mph) and lower. This change in the fuzzy class allowed us to reduce three rules to one. In general, it is desirable to use the minimum rule base necessary for ease in understanding and tuning the fuzzy logic controller, and method 2 achieves that with better results than method 1.

### **Defuzzification**

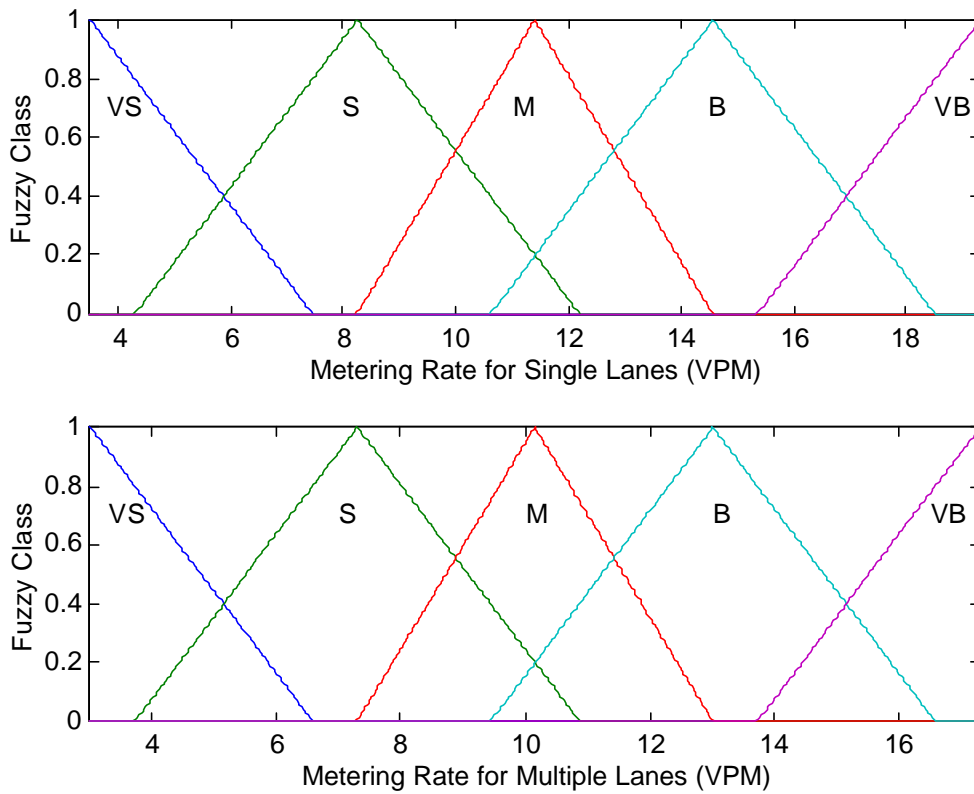
The last step in the FLC is to produce a numerical metering rate given all of the rule outcomes. Just as the inputs to the controller are represented by fuzzy classes to translate from a numerical input to a set of linguistic variables, so is the metering rate represented

by a set of fuzzy classes to convert from a set of linguistic variables to a single metering rate. This reverse process from a fuzzy to a *crisp*, or quantitative state, is known as *defuzzification*. The fuzzy classes for a single metered lane are shown in the top of Figure 4. In this figure, it is apparent that the very big class has a centroid of 18.0, and the very small class has a centroid of 4.5, while the other class centroids range between these. For ramps that merge with other metered lanes before entering the mainline, the metering classes are shown in the bottom of Figure 4. Because the default maximum metering rate is 18.0 for single metered lanes and 16.0 otherwise, the range of the fuzzy classes is higher for single metered lanes. Like any of the inputs to the controller, the metering rate classes can be tuned. Tuning the metering rate classes can have a profound effect on the ramp metering behavior, as explained in the section, Tuning the Metering Rate.

The implicated area of each rule outcome is found by scaling its fuzzy metering class by its activation degree. The centroid of the rule outcomes is found with the following equation, where each rule's implicated area is multiplied by the rule weighting:

$$Metering\ Rate = \frac{\sum_{i=1}^N w_i c_i I_i}{\sum_{i=1}^N w_i I_i}$$

where  $w_i$  is the weighting of the  $i$ th rule,  $c_i$  is the centroid of the output class, and  $I_i$  is the implicated area of the output class.



**Figure 4. Default Fuzzy Classes for Metering Rates of Single and Multiple Lanes**

For instance, suppose the rules that are active at a given moment are the following:

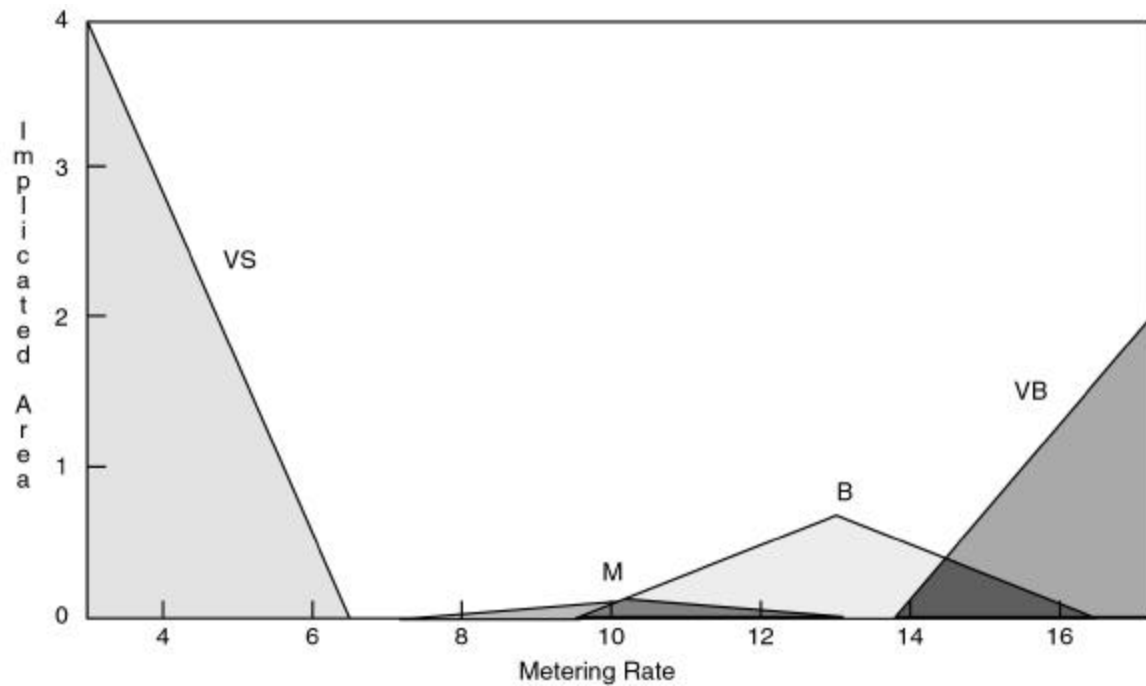
Rule 3: Metering Rate is medium to a degree of 0.2, weighted by 1.0

Rule 4: Metering rate is big to a degree of 0.7, weighted by 1.0

Rule 10: Metering Rate is very small to a degree of 1, weighted by 4.0

Rule 11: Metering Rate is very big to a degree of 1.0, weighted by 2.0

Figure 5 shows the implicated area for each output class -- scaled by its degree of activation, multiplied by its rule weight, and summed over all rules. The discrete fuzzy centroid calculation produces a metering rate of 8.7 VPM for this example.



**Figure 5: Defuzzification Calculation**

### ***HOV Adjustment***

The HOV adjustment made to the metering rate is determined by the fuzzy logic controller. This adjustment further reduces the metering rate to account for HOVs and violators that bypass metering. The HOV adjustment is the HOV passage volume (calculated from the past two minutes of data and converted to vehicles/minute) scaled by the percentage adjustment that is specified for that lane.

This flexible design overcomes the problems with the previous metering algorithms. With the Local and Bottleneck algorithms, the entire HOV adjustment was made to the metered lane adjacent to the HOV bypass, rather than distributing evenly across both metered lanes. Because the old HOV adjustment could have a big effect, often reducing the metering rate to its minimum, there was a noticeable discrepancy between rates of adjacent metered lanes on high-volume ramps. Motorists would call and complain



about this problem. For this reason, the fuzzy logic ramp metering algorithm is designed so that the HOV adjustment can be distributed among whichever lanes we want that HOV bypass to affect.

Typically, we want any metered lanes that merge with the HOV lane before merging with the mainline to have an HOV adjustment. The adjustment can be tuned by specifying what percentage of the HOV bypass volume should be subtracted from each lane's metering rate. For adjacent metered lanes, we specify an identical percentage of HOV adjustment to produce identical metering rates. If a third metered lane is affected by the HOV merge yet has independent demand, we will specify an HOV adjustment for it, but it may be different than that of the other lanes.

### ***Handling Bad Data***

The Fuzzy Logic Ramp Metering Algorithm has some features for handling bad data. If multiple detectors are used to calculate an input, the controller uses the loops flagged good and ignores the detectors flagged bad. If multiple samples are used to calculate an input, the controller will use the samples flagged good and ignore the samples flagged bad.

Data compensation is performed for some inputs. If no good data are available for the local input, the algorithm will temporarily use the upstream input as a substitute. The local input is important within the fuzzy logic controller because at least one of the local rules (in Table 2, rules 1-5) must activate at all times for the input space to be defined. If neither the local nor upstream input is unavailable, the fuzzy logic ramp metering algorithm will not calculate a metering rate. In this situation, control falls back to the next type of ramp metering in the control hierarchy. (See the following section.)

The queue and advance queue inputs compensate for each other if one is bad. If all of the queue input data is bad, the rule weight for the queue occupancy (rule 11) will be zeroed to disable this rule, and the rule weight for the advance queue occupancy (rule 12)

will be increased by the queue occupancy rule weight. Conversely, if the advance queue occupancy input are bad, its rule will be disabled, and the queue occupancy rule will compensate with the additional weighting of the advance queue occupancy rule weight. If neither of these ramp inputs are available, the fuzzy metering algorithm will not calculate a metering rate. Without any ramp data, the only inputs active are for mainline rules, which may produce too restrictive a metering rate without the ramp rules to balance them. To avoid this situation, control temporarily falls back to the next type of metering in the control hierarchy.

For the local speed inputs (rules 6-9) and downstream inputs (rule 10), these rules are disabled when no data are available. They are not essential to the operation of the fuzzy logic algorithm, so a fuzzy metering rate will still be calculated without these rules.

More challenging than data that are correctly flagged bad are data that are flagged good but are inaccurate. The controller thinks that the data are good. The nature of the fuzzy logic controller allows it to handle imprecise data without a problem. Even if a particular rule does not produce the optimal output class, another rule may produce the correct rule. The parallel rule evaluation of the fuzzy logic controller increases the robustness to bad data. Because the fuzzy logic controller preprocesses the data rather than calculating the metering rate directly from raw data, the error is not propagated throughout the calculation. Most of the time, the desired fuzzy class will still activate, and consequently, the desired metering class will be produced. The reason for this is that most of the time, traffic conditions are on one end of the spectrum or the other because transitions between free-flow conditions and heavy congestion occur quickly. Suppose the real local occupancy is 30 percent, but the detector reads 50 percent occupancy. In both cases, the very big class is true to a degree of 1.0, so there is no error when traffic conditions are outside the dynamic range.

In the event that a detector are inaccurate enough to cause a noticeable error, there are a couple of options. One is to redefine the fuzzy classes to account for the discrepancy.

That the data is inaccurate is not important. What is important is that the controller produces the correct response for the data it is given. Another option is to redefine the detectors used to calculate the input. Instead of using the station data that include the bad loops, use only the good loops within that station. (See Compensating for Inaccurate Data).

### **Control Hierarchy**

We now have an assortment of ramp metering algorithms to choose from. How do we know which one will be in operation at which time? Essentially, the control hierarchy is unaltered except that fuzzy metering has been added to the top of the ramp metering decision tree. If a fuzzy metering rate is enabled and calculated, the 170 will directly implement it, without making any adjustments to it.

A fuzzy metering rate will not be implemented if any of the following conditions occur:

- Fuzzy metering is disabled by setting the parameter **PermitFuzzyMr** to “NO” for that metered lane.
- Data were insufficient to calculate a fuzzy metering rate.
- The **ControlSwitch** is not set to Central for that ramp metering cabinet.

In any of these situations, control falls back to the next type of metering in the hierarchy. Central metering algorithms are those calculated within the VAX, including fuzzy metering and bottleneck. If the **ControlSwitch** is set to “Central” and a fuzzy metering rate is not calculated, the minimum rate between the Bottleneck and Local algorithm will be used, providing that Bottleneck is enabled. If Bottleneck is not enabled but the **ControlSwitch** is set to “Central,” the Local metering rate will be used. If the **ControlSwitch** is set to “TOD” (time-of-day), the minimum between the Local and TOD metering rate will be used. If communications between the VAX and 170 fail, the 170 will use the minimum between the Local and TOD metering. If the Local data are not available, the 170 will use TOD metering. For any type of metering rate aside from fuzzy metering, the 170 makes

further adjustments to the chosen minimum rate. It makes queue override, advance queue override, and HOV adjustments (See the TSMC training manual for details).

## ALGORITHM OBSERVATION

The best way to understand, observe, and evaluate the fuzzy logic ramp metering algorithm is through `watch_fuzzymeter.exe`, a stand-alone VAX utility. Log on to the VAX or to *VT320* (a VAX terminal emulator). Type “`exe`” to go to the executable directory. From there, type “`run watch_fuzzymeter.`” Hit ‘`W`’ to observe a ramp. Then hit the number that corresponds to the metered lane that you want to watch (each metered lane has its own display). Hit a key to exit at any time.

ES-740R I-405 MP:22.46 Loc:NE 160th St-SB OFF 10/08/99 11:39:00->19

INPUTS	CRISP	VS	S	M	B	VB
Local Occ	10.2	1.0	0.0	0.0	0.0	0.0
Local Speed	49.7	0.0	0.0	0.0	0.9	0.0
Down Occ	18.3	-	-	-	-	0.5
Down Speed	40.9	0.9	-	-	-	-
Queue Occ	6.9	-	-	-	-	0.0
Adv Queue Occ	3.3	-	-	-	-	0.0
HOV Bypass	1.0	-	-	-	-	-
METER RATE	CRISP	VS	S	M	B	VB
11:39:00-> 19	10.5	2.0	0.0	0.0	0.9	1.0
11:38:40-> 59	11.3	1.9	0.0	0.0	0.7	1.8
11:38:20-> 39	11.6	1.7	0.0	0.0	0.7	2.0
11:38:00-> 19	12.8	1.3	0.0	0.0	0.5	2.5

IF INPUT	RATE	WEIGHT	OUTCOME
LocalOccVb	VS	2.5	0.0
LocalOccB	S	1.0	0.0
LocalOccM	M	1.0	0.0
LocalOccS	B	1.0	0.0
LocalOccVs	VB	1.0	1.0
LocSpVs_OccVb	VS	3.0	0.0
LocalSpeedS	S	1.0	0.0
LocalSpeedB	B	1.0	0.9
LocSpVb_OccVs	VB	1.0	0.0
DownSpVs_OccVb	VS	4.0	0.5
QueueOccc	VB	2.0	0.0
AdvQueueOcc	VB	4.0	0.0

**Figure 6: Snapshot of *Watch\_fuzzymeter***

Figure 6 shows a snapshot of `watch_fuzzymeter` for the on-ramp NE 160<sup>th</sup> St to SB I-405. The screen is updated every 20 seconds. The top of the window displays a header with the cabinet name, roadway, milepost, cross-road, metering status, and the time period the window is currently displaying. On the left side of the window, the crisp, or numerical, data for each input is shown, calculated as specified in the fuzzy equation for that ramp. Adjacent to each input, the degree to which each relevant fuzzy class is active is shown. This is a good place to check that the controller is using optimal detectors (see Fuzzy Equations) to calculate that input by comparing the crisp values shown with the loop detector data displayed in TMS. Also, use this screen to check that the linguistic variables

are defined correctly for each input, as described in the Tuning section. The HOV bypass input shows 100 percent of the HOV passage volume in VPM (vehicles/minute).

On the right side, the weight of each rule is given, followed by the degree to which that rule is active (prior to multiplication with the rule weight). At the bottom of the screen, the metering classes are shown. For each class, the screen displays the sum of rule weights multiplied by the rule outcomes. In this instance,

$$\text{Metering Rate}_{\text{VS}} = 2.5*0.0 + 3.0*0.0 + 4.0*0.5 = 2.0$$

$$\text{Metering Rate}_{\text{S}} = 1.0*0.0 + 1.0*0.0 = 0.0$$

$$\text{Metering Rate}_{\text{M}} = 1.0*0.0 = 0.0$$

$$\text{Metering Rate}_{\text{B}} = 1.0*0.0 + 1.0*0.9 = 0.9$$

$$\text{Metering Rate}_{\text{VB}} = 1.0*1.0 + 1.0*0.0 + 2.0*0.0 + 4.0*0.0 = 1.0$$

To the left of the metering classes, the resulting metering rate is shown (after calculating the centroid of the implicated metering classes and making the HOV adjustment). The HOV adjustment is the HOV bypass input shown in the window, multiplied by the percentage of the HOV bypass volume applied to that lane. For this ramp, the HOV adjustment is 0.5 VPM, which is 50 percent of the HOV bypass. The algorithm's resulting metering rate is 10.5 VPM before being bound by the minimum and maximum allowable metering rates for that ramp. The metering rate window scrolls down every 20 seconds so that we can see the previously calculated metering rates.

## FUZZY EQUATIONS

The interface with the fuzzy logic ramp metering algorithm allows users to implement the algorithm by entering fuzzy metering equations in the *rmdb\_input.fil*, tune the controller with the fuzzy metering parameters, and observe the performance with a tool called *watch\_fuzzymeter.exe*.

### **Equation Prototype**

To implement the fuzzy logic ramp metering algorithm at a new location, fuzzy equations must be entered into the *rmdb\_input.fil*. Actually, “equation” is not an accurate word, but this terminology is consistent with the other traffic analysis programs (such as bottleneck, station aggregation, and incident detection.) The equations contain a specification of which detectors to use to calculate each controller input for a given ramp meter.

The prototype to use for a fuzzy metering equation is given under the new group heading called *Fuzzymeter\_Equations*:

```
[ Fuzzymeter_Equations ]  
ES-###R:xxxxFM# = LOCAL1 & LOCAL2 & ... & LOCAL5 |  
DOWN1 & DOWN2 & ... & DOWN20 | UP |  
QUEUE1(n_samples1) & QUEUE2(n_samples2) & ... &  
QUEUE5(n_samples5) |  
ADV_QUEUE1(n_samples1) & ADV_QUEUE2(n_samples2) & ... &  
ADV_QUEUE5(n_samples5) |  
HOV_BYPASS(percent_hov_adjust)
```

The first seven characters consist of the cabinet’s name, where “###” should be replaced with the cabinet number. Next is a colon, followed by four *don’t care* symbols. In order to be descriptive, it is recommended that the metered mainline roadway type is given for these characters, such as “MMS\_”. Following “FM” is the lane number to be metered

within that cabinet. A separate equation must be given for each metered lane. Inputs must be given in the following order: local, downstream, upstream, queue, advance queue, and HOV bypass, where only the HOV input is optional. In the prototype given, the items in italics are optional. Inputs of the same type must be delimited with an '&', and different type inputs must be delimited with a '|'. A space must be used around the equal sign, '&', and '|'. The number of samples used to calculate the Queue and Advance Queue inputs must be given in parentheses immediately following the loop/station name, with no spaces in between. If an HOV input is given, the percentage of HOV bypass applied to the lane must be specified in parentheses immediately after the HOV loop name.

For all inputs, it is possible to use loops, stations, or any combination of both. The controller calculates the input in units per minute per lane, averaging all contributing loops and stations according to the total *good* number of lanes and samples. (See Handling Bad Data). In other words, a station with multiple lanes will contribute more to the average occupancy than will a single lane. Typically, stations will be used for mainline inputs and loops will be used for ramp inputs. For the local, queue, and advance queue inputs, the equation may specify up to five loops/stations. For the downstream input, the equation may specify up to 20 loops/stations. For the upstream and HOV bypass, the equation may specify only one loop/station.

### ***Error Checking***

For the equation to take effect, the Ramp Metering Data Base (RMDB) must be rebuilt when the Traffic Management Software (TMS) is off-line. It is recommended that a test rebuild be attempted before any actual system rebuild to prevent any system down time. The Configuration Management Software (CMS) does this for you if you edit *rmdb\_input.fil* within it.



**Table 3. Equation Error Checks Performed in Build RMDB**

EQUATION CHECK PERFORMED	ERROR MESSAGE
Data Column type must be either a ramp meter or a data collector	“Fuzzy meter Eqn valid only for RM or DC”
Characters 13 and 14 must be the string ‘FM’	“Wrong equation type - Must be FM for Fuzzy Meter”
Metered cabinet must match the current cabinet name	“Metered cabinet name doesn't match column name or bad fuzzy eqn continues”
The cabinet name to be metered must use the correct format	“Cabinet/loop name to meter is not valid in fuzzy eqn”
All detector names must use complete 15 character format, using the cabinet name, followed by a ‘:’, then either the station or loop name (the parser does not assume current cabinet as in Bottleneck equations)	“Cabinet/loop name not found in fuzzy eqn” (The error check that this detector actually exists is not performed until later during tms_startup)
A detector name must be continuous within a line with no spaces in between	“Cabinet/loop name not found in fuzzy eqn”
The controller inputs must be given in the order of local, downstream, upstream, queue, advance queue, and HOV.	None—The parser might catch this error through a subsequent check, but has no way of knowing if the order is incorrect
The number of inputs (delimited by ‘ ’) may not exceed six.	“Too many  's delimiting locations in fuzzy eqn”
Up to five loops/stations each are allowed for the Local, Queue and Advance Queue Inputs	“Too many loops of a station type in fuzzy equation”
Only one loop/station each is allowed for the Upstream and HOV sinput	“Too many loops of a station type in fuzzy equation”
Up to 20 loops/stations are allowed for the Downstream input	“Too many loops of a station type in fuzzy equation”

**Table 3. Equation Error Checks Performed in Build RMDB (continued)**

EQUATION CHECK PERFORMED	ERROR MESSAGE
' ' must be used to delimit different input types	"Missing delimiter -- expecting ' & ' or '   ' to continue fuzzy eqn"
'&' must be used to delimit stations/loops of the same input type	"Too many  's delimiting locations in fuzzy eqn"
An equation to be continued on the next line must end with a delimiter '=', ' ', or '&'	"Missing delimiter -- expecting ' & ' or '   ' to continue fuzzy eqn"
The HOV input is the only optional input.	"Missing delimiter in fuzzy eqn -- expecting & or  " or "Queue or Advance Queue loops are missing from fuzzy eqn"
The number of samples used to calculate the Queue and Advance Queue inputs must be given in parenthesis following detector name, with no spaces in between.	"Number of samples for queue or percent adjustment for HOV not found in fuzzy eqn"
If there is not an HOV input, the equation must end with the Advance Queue input, followed by the number of samples -- not a delimiter	"Cabinet/loop name not found in fuzzy eqn"
HOV loop must be a passage loop containing the string "HP"	"Loop for HOV Bypass in fuzzy eqn is not of correct type"
The percentage of HOV bypass applied to a lane must be specified in paranthesis immediately after the HOV loop name	"Number of samples for queue or percent adjustment for HOV not found in fuzzy eqn"
The percentage of HOV bypass applied must be between 0 and 100	"Percent adjustment for HOV Bypass is out of 0-100 range in fuzzy eqn"
Do not put more than one equation per line. (This differs from the other Traffic Analysis Programs.)	Either second equation will not be found or several possible messages will be generated if the second

	equation continues to the next line
--	-------------------------------------

Several equation error checks are done when you run *build\_rmdb.exe*. If an error occurs during the rebuild, an error message is written both to the screen and to *rmdb\_error.fil* (found in the executable directory). Table 3 lists the test performed during the building of RMDB and the error messages generated. Quite often, more than one error message will be generated by a single error. Subsequent errors are common because the equation parser discards the remainder of the line when it finds an error in that equation. It searches for the beginning of the next equation and then produces errors when that line (often a continuation of the bad equation) does not resemble the beginning of the next equation. For this reason, first fix the first error listed (the real error) and then determine whether any errors persist on the next rebuild. Depending on how creative the user is with writing equations, it is possible that error messages other than the ones listed will occur. Table 3 lists the most probable error messages generated for a given event.

Some liberties are allowed in equation writing. Spaces and tabs surrounding detector names are considered to be *white space*, and are discarded by the parser. (Don't try this with any other Traffic Analysis Programs.) The order of detector names *within* a given input type is optional. However, for ease of understanding the equation, it is recommended that they are given in order. More than one input may be given per line. In general, the equations should be formatted for the best readability.

Fuzzy equations that are successfully built are written to a file called *fuzzy\_meter.eqn* in the executable directory. This file is the most concise and accurate way to view the fuzzy equations operating the ramp meters. Fuzzy equations that contain errors discovered during the RMDB build are not written to this file. The equations are reformatted to contain four loop/stations per line. This file is used upon *tms\_startup* to build a table of pointers to the real time data that the controller needs.

When *tms\_startup.exe* is run, further error checking is performed by the *fuzzymeter* software. Table 4 summarizes the additional checks that are performed and the associated error message generated to the screen, to the process *mon\_event\_log*, and to the event log

file. There are two common errors in misnaming the cabinet:station names. 1) “R” is used instead of “D” in the seventh character of the cabinet name, or vice versa, such as “ES-061R” instead of “ES-061D”. This character indicates whether the cabinet is a ramp meter or data collector type. 2) The first character of the station name is “\_” instead of “M”, or vice versa, such as “\_MN\_Stn” instead of “MMN\_Stn”. This character indicates whether this station is used by the 170 to calculate the Local Metering Rate. Because the software does not know whether the detector names given in the equations exist in the RMDB until start-up, it is a good idea to double-check the equations before re-starting the system. Although start-up will proceed if there are errors (no other equations or processes will be affected), the system will not be able to fuzzy meter any lanes with bad equations.

**Table 4. Equation Error Checks Performed Upon Start-up**

EQUATION CHECK PERFORMED	ERROR MESSAGE
The cabinet name must exist in RMDB	“Eqn:Cabinet name not in RMDB – skipped”
The cabinet station/loop name must exist in RMDB	“Station:loop name not found”
The number of samples to calculate the queue inputs and the percentage of HOV bypass must be less than 128 (1 byte size)	"Number of samples for queue or percent HOV adjustment is too large"

A third common error is to specify the incorrect lane number to be metered immediately following the “FM” characters. If the lane is called lane 2, the equation must read “FM2” even if there is no lane 1 within the cabinet. When the user mistakenly calls this “FM1” the error checking cannot catch this problem. Fuzzy metering will calculate a

metering rate and send it to lane 1. Lane 2 will not have a fuzzy metering rate, and lane 1 will have the wrong fuzzy metering rate.

Not all equations listed in *fuzzy\_meter.eqn* necessarily survive the restart when an error in Table 4 occurs, but no equation should fail in *build\_rmdb.exe* or *tms\_startup.exe* without an error message. However, if the user is not watching *mon\_event\_log.exe* during start-up, it is possible that a start-up error could escape notice. For this reason, after a system restart, it is recommended that the user run *watch\_fuzzymeter.exe* to verify that all new equations that were entered into *rmdb\_input.fil* are listed as one of the metered lanes that can be observed. If the third common mistake is made, *watch\_fuzzymeter.exe* will list the incorrect metered lane. (See ALGORITHM OBSERVATION.)

### **Equation Examples**

Writing the optimal equations for fuzzy metering is something of an art that requires an understanding of the algorithm, knowledge of the site, and critical thinking. Rather than plugging and chugging through this procedure, you can utilize the flexibility of the algorithm design to your advantage by understanding how each input is used. Apply these guidelines, but be aware of how modifying the inputs can achieve different effects to handle the peculiarities of each site.

#### **Local Input**

For the local input, the mainline station just upstream of the merge is typically used. Most commonly, this station is within the metered cabinet and is the one used by the Local Metering Algorithm. In general, it is highly recommended that only this station be used, rather than averaging multiple stations together. In almost all cases, one station represents the merge conditions better than any other station. In the event that the merging causes a mainline bottleneck, the station just upstream will capture the resulting congestion, but the station downstream of the merge will not necessarily (unless there is significant weaving

or geometrical causes for the local bottleneck). Downstream conditions are taken into account in the downstream input and rules, not in the local input. Averaging the local station with another station will debase the accuracy of the local merge conditions. In particular, we want the station that best correlates with secondary queue formation. For highly congested ramps, this is the main constraint on the ramp metering rate.

The system allows up to five local loops/stations to handle cases in which the detector data do not accurately reflect local conditions. One example of this was the Ravenna to I-5 SB on-ramp. Lanes 1 and 4 read lower occupancy than lanes 2 and 3. This discrepancy occurred because the amplifier for lanes 1 and 4 was turned too low. CCTV images revealed that the higher occupancies of lanes 2 and 3 were a better representation of the merge conditions than the occupancies of lanes 1 and 4. To improve the accuracy of the local data, “ES-141R:MMS\_\_\_2 & ES-141R:MMS\_\_\_3” were used instead of “ES-141R:MMS\_Stn” for the local input until recalibration of the amplifier:

```
ES-141R:MMS_FM1 = ES-141R: MMS___2 & ES-141R:MMS___3 |  
ES-105D:_MS_Stn & ES-118R:_MS_Stn & ES-128D:_MS_Stn &  
ES-130D:_MS_Stn & ES-136R:MMS_Stn | ES-143D:_MS_Stn |  
ES-141R:_MS_Q_1(1) | ES-141R:_MSRA_1(1)
```

At over 100 metered lanes where fuzzy metering has been implemented, a downstream station has been averaged with the station upstream of the merge to improve the accuracy of the local data in only one instance. The ramp where this has been found to be effective is Montlake to 520 EB in the afternoon. This ramp has extremely high volumes and an extremely congested merge. Unfortunately, the local station is too far upstream to accurately correlate with secondary queue formation. When the local occupancy appears to be 40 percent occupancy with the camera, the local station may read as low as 8 percent, until the bottleneck, exacerbated by the merge, reaches back to the local station. Suddenly, the local station will jump up, but by then, the secondary queue is extensive. We want the ramp metering to be more preventative of the secondary queue and mainline bottleneck. The

downstream station, on the other hand, often reads a higher occupancy than what appears at the local merge. Neither the downstream detector nor the upstream detector accurately represents the merge condition. The truth is usually somewhere in between and is best approximated by averaging the two stations in the following equation.

$$\begin{aligned} \text{ES-504R:MME\_FM2} &= \text{ES-504R:MME\_Stn} \& \text{ES-506R:MME\_Stn} \mid \\ &\text{ES-506R:MME\_Stn} \& \text{ES-514D:\_ME\_Stn} \& \text{ES-519R:MME\_Stn} \mid \\ &\text{ES-502D:\_ME\_Stn} \mid \\ &\text{ES-504R:\_ME\_I\_2(2)} \mid \text{ES-504R:\_MERA\_2(2)} \mid \text{ES-504R:\_MEHP\_2(50)} \end{aligned}$$

Note that in this equation, ES-506R is used both as a local and a downstream input. Although this instance is unusual, the logic does not prohibit using the same detectors in more than one input.

The station that best represents the local merge condition is not always in the same cabinet as the metered lane. For example, the loop ramp of EB NE 8<sup>th</sup> to NB 405 merges with the metered slip lane of WB NE 8<sup>th</sup> in cabinet ES-694 before entering the mainline (Figure 7). The mainline station ES-694R:MMN\_Stn is actually closer to the mainline merge than ES-693R:MMN\_Stn, yet ES-694R:MMN\_Stn is still upstream of the mainline merge. The equations for ES-693R and ES-694R use the same local station:

$$\begin{aligned} \text{ES-693R:MMN\_FM2} &= \text{ES-694R:MMN\_Stn} \mid \text{ES-696D:\_MN\_Stn} \mid \\ &\text{ES-693R:MMN\_Stn} \mid \text{ES-693R:\_CN\_Q\_2(1)} \mid \text{ES-693R:\_CNRA\_2(2)} \mid \\ &\text{ES-693R:\_CNHP\_2(30)} \\ \text{ES-694R:MMN\_FM2} &= \text{ES-694R:MMN\_Stn} \mid \text{ES-696D:\_MN\_Stn} \mid \\ &\text{ES-693R:MMN\_Stn} \mid \text{ES-694R:\_CN\_Q\_2(1)} \mid \text{ES-694R:\_CNRA\_2(2)} \mid \\ &\text{ES-694R:\_CNHP\_2(30)} \end{aligned}$$



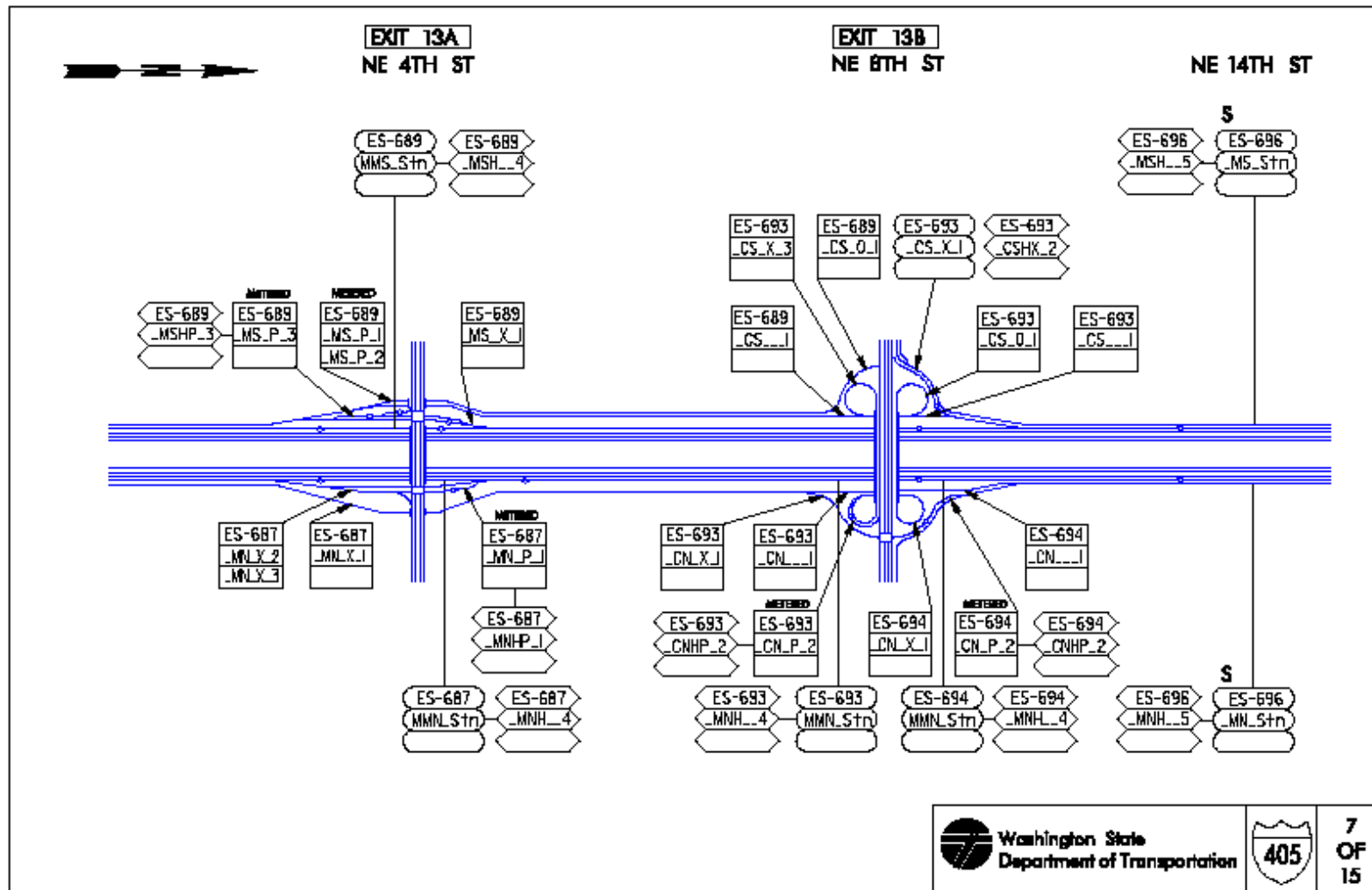


Figure 7: Local Input for EB NE 8th to NB 405

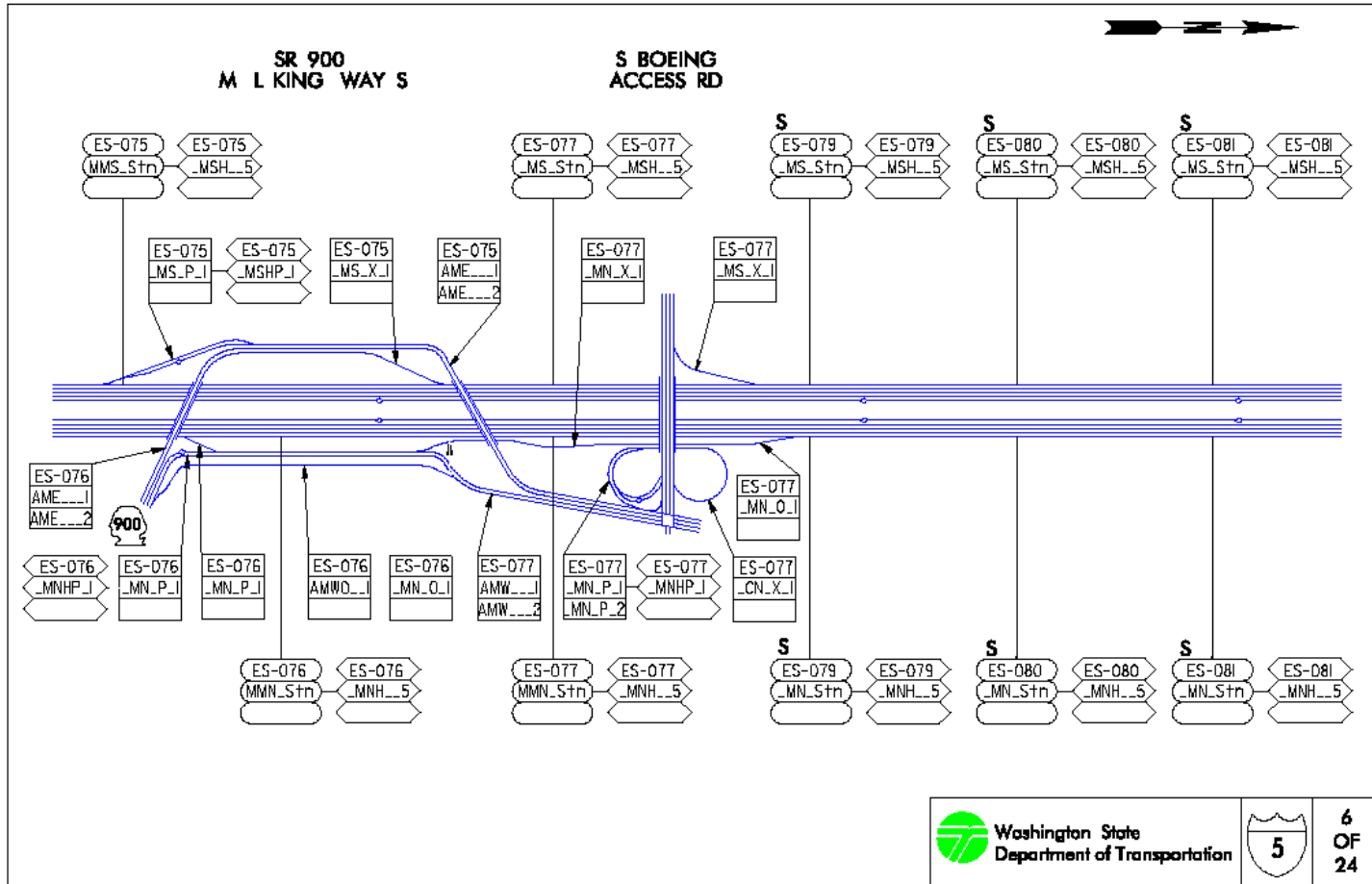


Figure 8: Local Input for Boeing Access Road to NB I-5

In a couple of instances, the station that has best represented the local conditions has been downstream of the merge. In general, detectors downstream of the merge should not be used as a local input because they may be downstream of the congestion caused by the merge. However, in the case of the Boeing Access Road to NB I-5, the station just downstream of the merge, ES-079R:\_MN\_Stn, is much closer to the merge than is the adjacent upstream detector, ES-077R:MMN\_Stn (Figure 8). Histograms of historical break-down show that ES-077R:MMN\_Stn best represents the congestion caused by the merge. If in doubt about which station to use as the local input, compare the break-down histograms for each station. See the user manual on how to make plots (Ishimaru and Hallenbeck, 1999).

```

ES-077R:MMN_FM1 = ES-079D:_MN_Stn | ES-083D:_MN_Stn &
    ES-088D:_MN_Stn & ES-093D:_MN_Stn & ES-104D:_MN_Stn |
    ES-076R:MMN_Stn | ES-077R:_MN_Q_1(2) | ES-077R:_MNRA_1(2) |
    ES-077R:_MNHP_1(25)
ES-077R:MMN_FM2 = ES-079D:_MN_Stn | ES-083D:_MN_Stn &
    ES-088D:_MN_Stn & ES-093D:_MN_Stn & ES-104D:_MN_Stn |
    ES-076R:MMN_Stn | ES-077R:_MN_Q_2(2) | ES-077R:_MNRA_2(2) |
    ES-077R:_MNHP_1(25)

```

Of all the fuzzy metered ramps in the Northwest District, there is one instance in which the local input is on the collector-distributor rather than the mainline. 4<sup>th</sup> Ave S to SB I-5 is metered for the benefit of the merge on the collector-distributor between the volume from downtown and I-90, rather than for the mainline merge (Figure 9). In fact, the volume from I-90 is not metered because this exchange is interstate to interstate. In this case, the collector-distributor loop ES-100R:MCS\_\_\_1 from downtown best represents this merge because it is more congested and takes longer to dissipate than the collector-distributor loop ES-100R:\_MS\_O\_1 from I-90. In this unusual example, the local mainline station is used as a downstream bottleneck input.

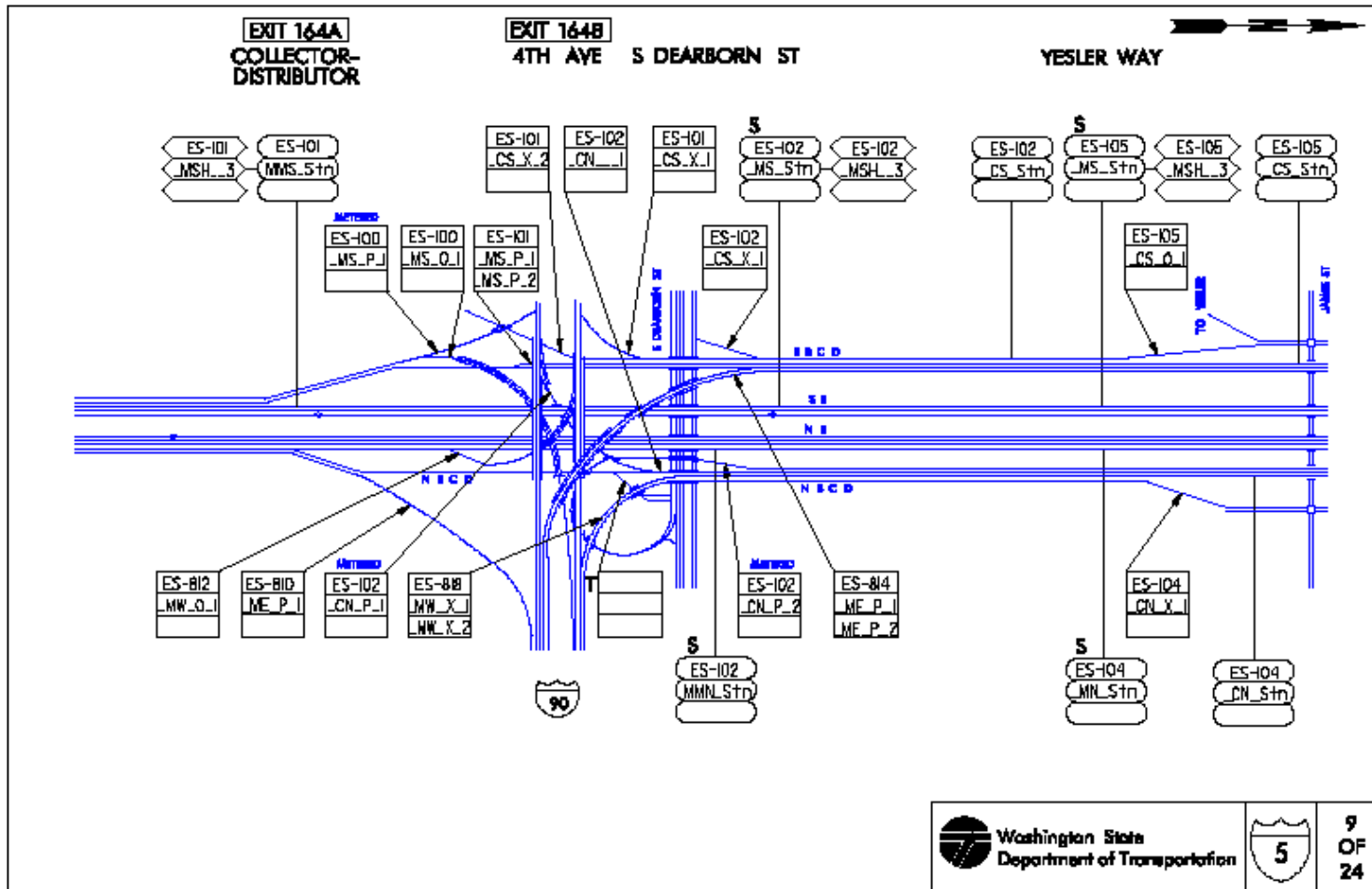


Figure 9: Local Input for 4<sup>th</sup> Ave South to SB I-5

ES-100R:MMS\_FM1 = ES-100R:MCS\_\_\_1 | ES-101R:MMS\_Stn &  
ES-093D:\_MS\_Stn & ES-085R:MMS\_Stn & ES-070R:MMS\_Stn &  
ES-059D:\_MS\_Stn | ES-102R:\_MS\_Stn | ES-100R:\_MS\_Q\_1(2) |  
ES-100R:\_MSRA\_1(2)

### **Downstream Input**

Because the downstream input uses the maximum occupancy of the specified downstream loops/stations and the speed associated with it (all other inputs use the average), multiple stations for this input are desirable. The downstream detectors should include locations that are prone to bottlenecks that the given ramp meter can mitigate. After determining the bottleneck locations, consider whether additional detectors are needed for good incident coverage and poor data handling.

When implementing fuzzy metering on a new corridor, it is easiest to start with the most downstream ramp meter and work upstream because heavy congestion travels from downstream to upstream. Begin with the most downstream location that you would want the ramp meter to affect. Knowledge of origin-destination should be taken into account when determining how far downstream a ramp meter *can* affect. Politics may be considered when determining how far downstream a ramp meter *should* affect. If you have no information about origin-destination for this corridor, one way of gauging the exit volumes is through the change in average mainline volumes shown in the histogram of breakdown frequency plots before and after exit ramps.

Bottleneck-prone locations are most easily determined by studying histograms of breakdown frequency for stations as far downstream as the ramp meter may affect. When making these plots, include all days of the week on which metering regularly takes place, and use the same range of dates (at least two months' data) for all plots in order to compare the relative likelihood of breakdown. (Plots for all corridors have already been

made for system-wide implementation and exist in a notebook in Freeway Operations at WSDOT, but new plots may be needed for new corridors or as traffic patterns change over time.)

When a station's frequency of breakdown is higher than the station upstream of it, the source of additional congestion should be considered. Most of the time, the cause of the bottleneck can be determined from comparing the histograms with the site geometry and station locations (available in the on-line data station reference guide at [http://www.wsdot.wa.gov/regions/northwest/NWFLOW/rmp\\_rdwy/DataStationReference.pdf](http://www.wsdot.wa.gov/regions/northwest/NWFLOW/rmp_rdwy/DataStationReference.pdf)).

Common causes of recurrent bottlenecks are on-ramp merges, back-up from exit ramps, weaving patterns, curves in the roadway, uphill sections of roadway, tunnels, and bridges. Because the mainline queue forms upstream of the bottleneck, down-sized versions with the same shape as the original breakdown histogram will continue upstream of the initial bottleneck. The most pronounced breakdown of the downstream station is the original bottleneck source; this is the one that we want to include as an input. If the histogram shape upstream of a bottleneck is not simply a smaller version but actually has a higher breakdown frequency for some times of the day, then unique features at this location are contributing to additional congestion. In this situation, this station should be included as a bottleneck input as well. Even if a station does not have a high chance of breakdown, it may form a bottleneck at certain times of the day or may be prone to incidents. The stations that are used as bottleneck inputs are not necessarily all of the ones with the highest frequency of breakdown, but the original sources of additional congestion relative to their downstream station.

To illustrate this process, let's examine SB SR 167, which has three metered ramps: S 277<sup>th</sup> St, SR 516, and 84<sup>th</sup> Ave S. (See Figures 10-12.) Histograms of breakdown frequency are shown in the Figures 13 through 22 for the period between 14:00 and 20:00 on Tuesday through Thursday. For corridors that are metered in both

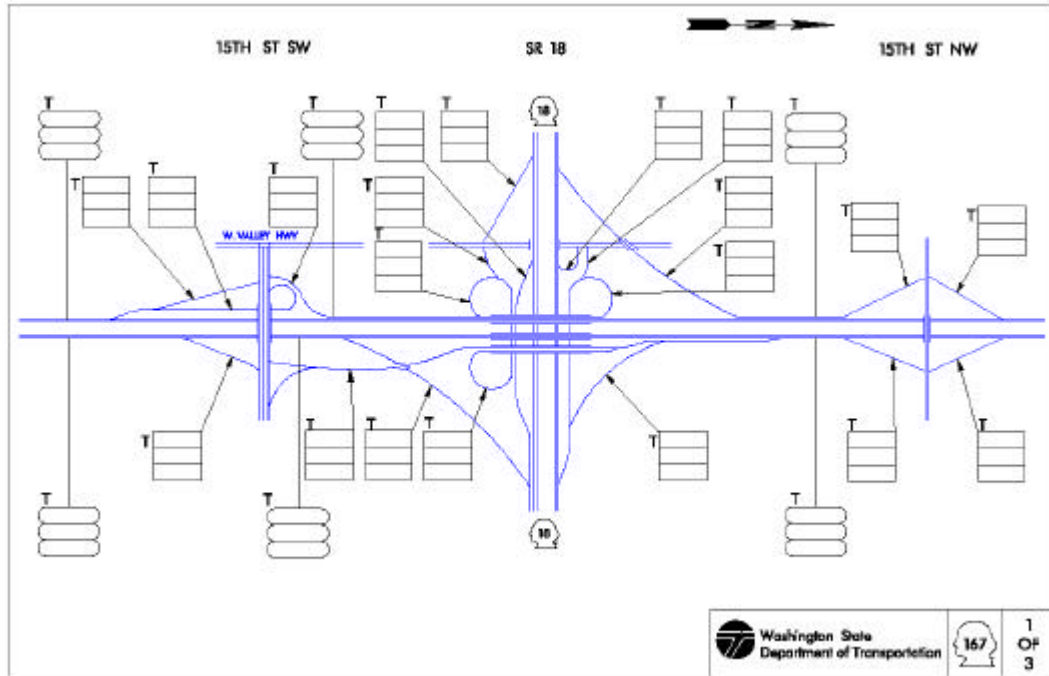


Figure 10: Bottleneck Input ES-310R for SB SR-167

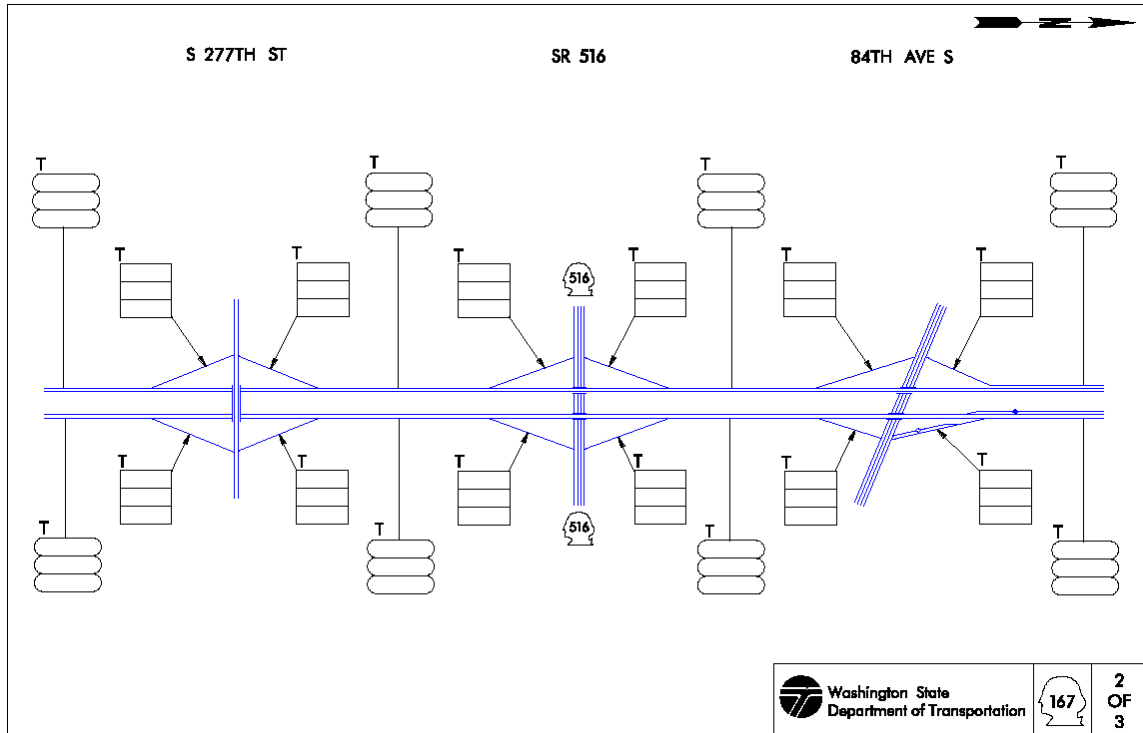
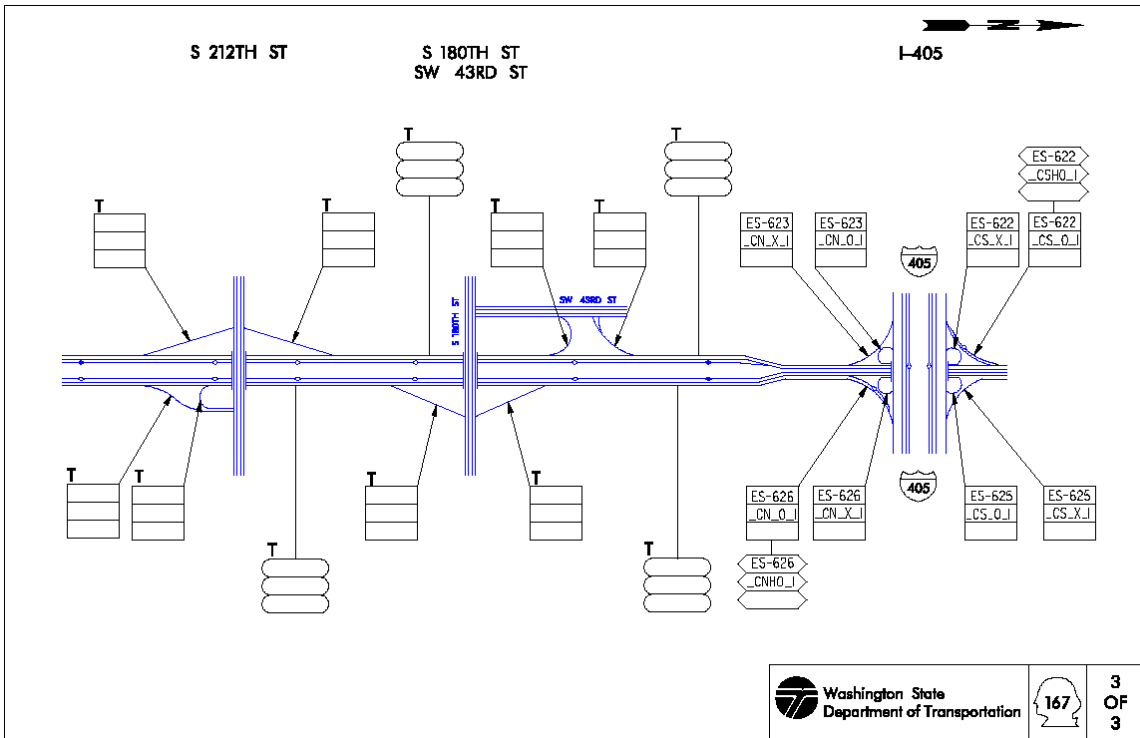


Figure 11: Bottleneck Input ES-314D and ES-317D for SB SR-167



**Figure 12: Bottleneck Input ES-319D for SB SR-167**

the morning and afternoon, use the histograms for the peak period to determine the bottleneck inputs. Then verify that the equations will work for the other metering period as well. Starting with the most downstream station, a small bottleneck is apparent at ES-310D:\_MS\_Stn (Figure 13). Because this is the most southern station in the corridor, we do not know from the histograms alone whether this bottleneck is caused by the on-ramp merge at 15<sup>th</sup> St NW or from backup caused by the exit to SR 18. In either case, this station should be included as a bottleneck input. Continuing upstream, we can see scaled-down versions of this breakdown histogram at ES-311D:\_MS\_Stn (Figure 14) and ES-312D:\_MS\_Stn (Figure 15). Because these stations do not represent the initial bottleneck, they do not need to be included as inputs. The next bottleneck input to include is ES-314D:\_MS\_Stn (Figure 16) because the congestion at this station is higher than the one downstream of it. When the bottleneck caused by an on-ramp merge is



### Estimated Weekday Volume, Speed, and Reliability

SR-167 15th St NW - GP SB

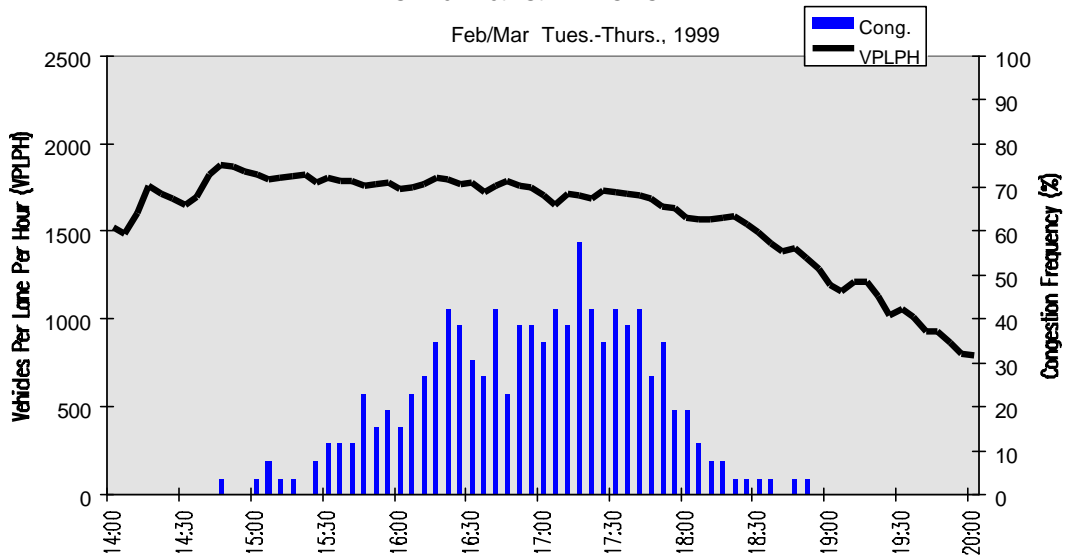


Figure 13: Breakdown Frequency of ES-310D: \_MS\_Stn

### Estimated Weekday Volume, Speed, and Reliability

SR-167 Emerald Downs GP SB

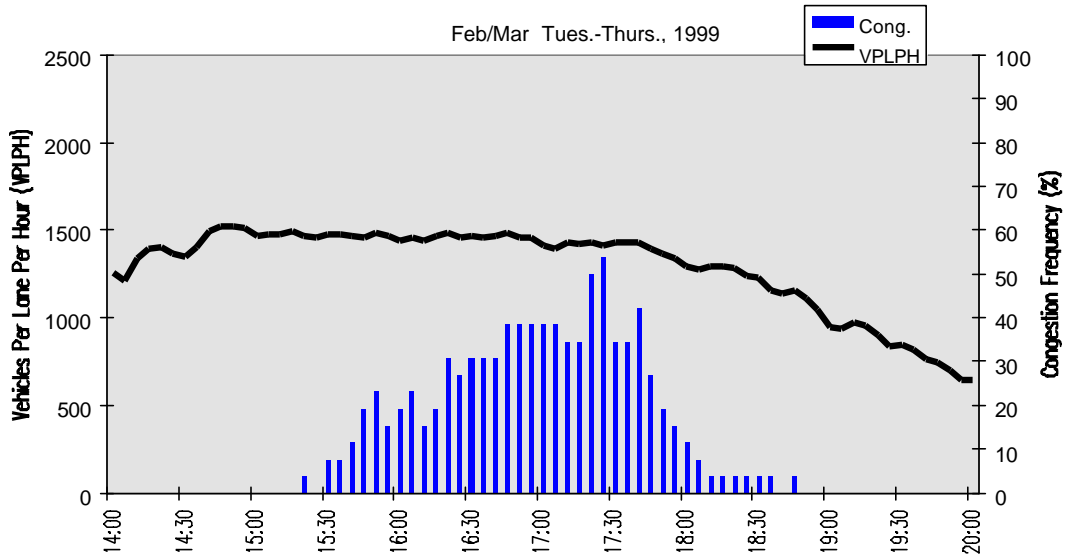


Figure 14: Breakdown Frequency of ES-311D: \_MS\_Stn

## Estimated Weekday Volume, Speed, and Reliability

SR-167 34th St NW GP SB

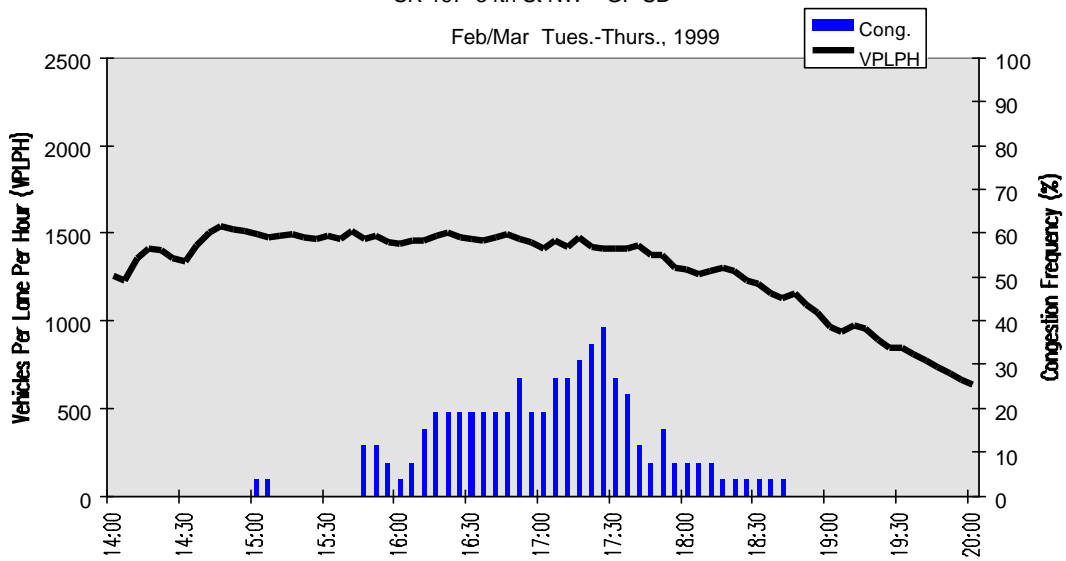


Figure 15: Breakdown Frequency of ES-312D: \_MS\_Stn

## Estimated Weekday Volume, Speed, and Reliability

SR-167 43rd St NW GP SB

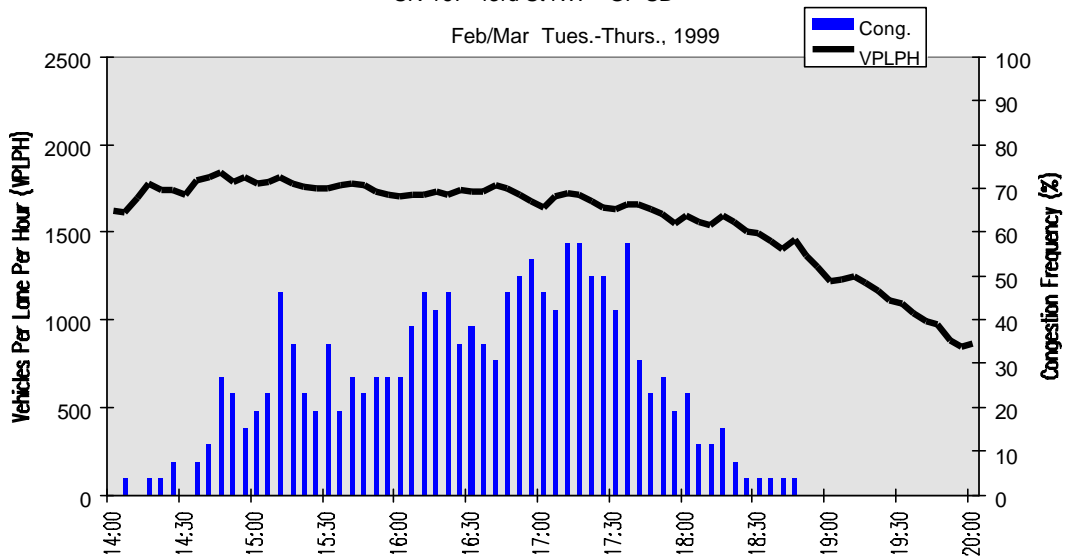


Figure 16: Breakdown Frequency of ES-314D: \_MS\_Stn

## Estimated Weekday Volume, Speed, and Reliability

SR-167 S 277th St - GP SB

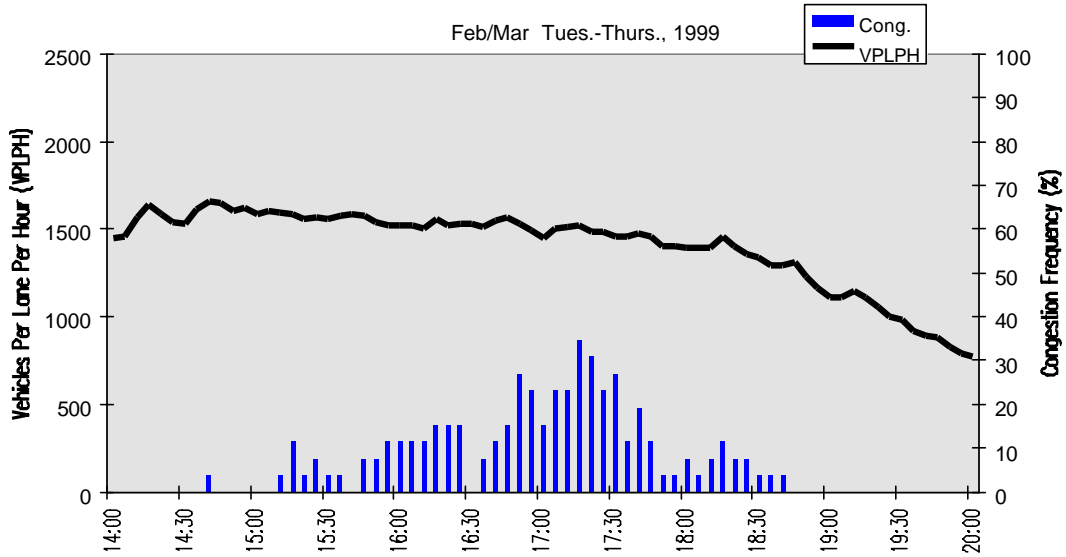


Figure 17: Breakdown Frequency of ES-315R:MMS\_Stn

## Estimated Weekday Volume, Speed, and Reliability

SR-167 S 269th St GP SB

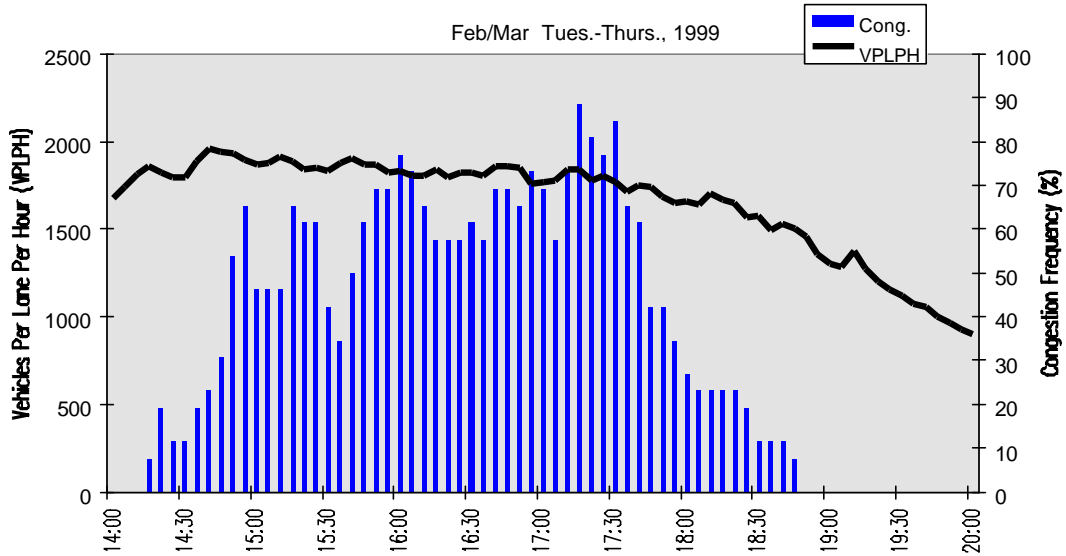


Figure 18: Breakdown Frequency of ES-317D:\_MS\_Stn

### Estimated Weekday Volume, Speed, and Reliability

SR-167 S 260th St GP SB

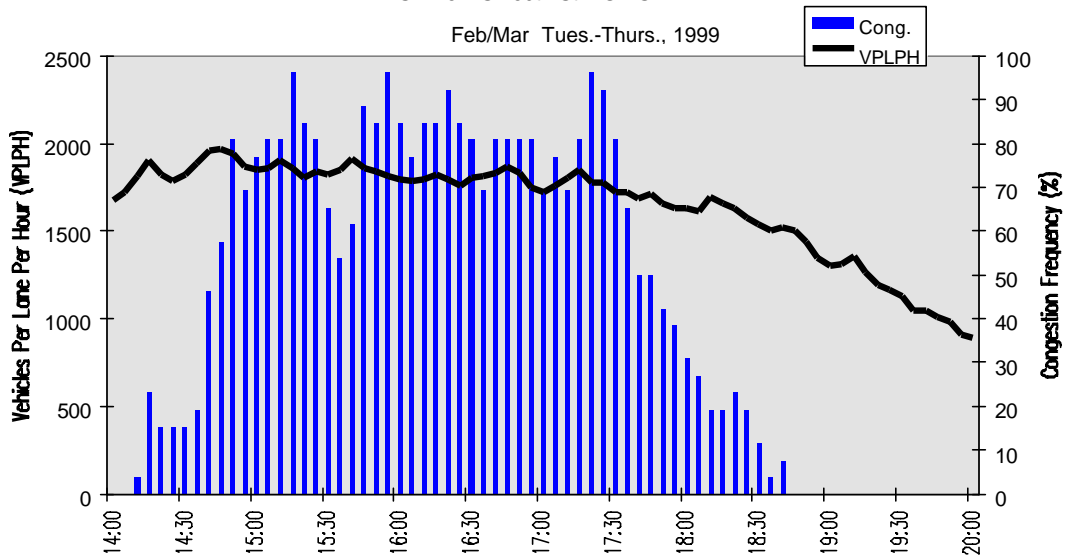


Figure 19: Breakdown Frequency of ES-319D:\_MS\_Stn

### Estimated Weekday Volume, Speed, and Reliability

SR-167 SR 516 - SB GP SB

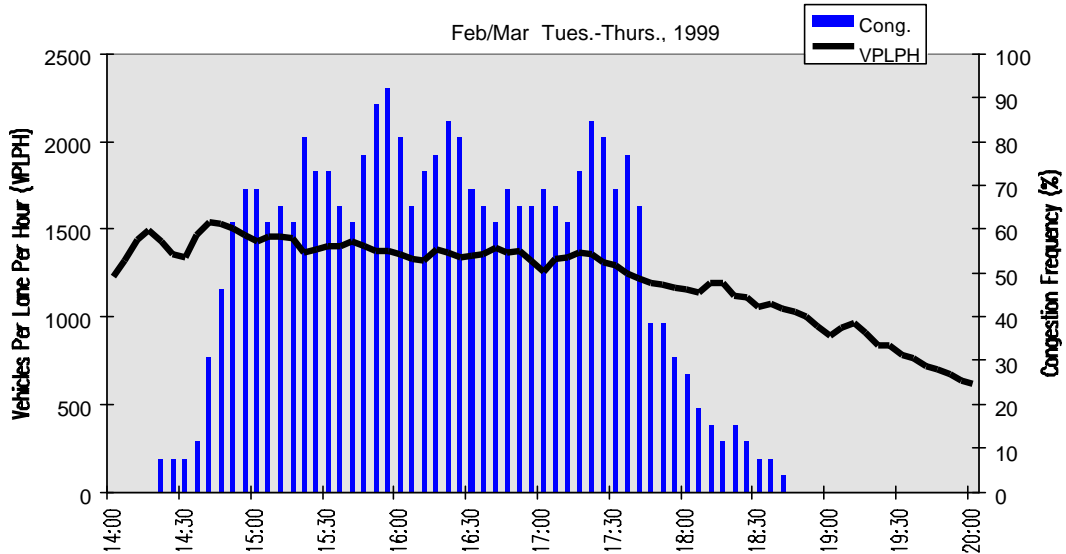


Figure 20: Breakdown Frequency of ES-320R:MMS\_Stn

## Estimated Weekday Volume, Speed, and Reliability

SR-167 4th Ave N GP SB

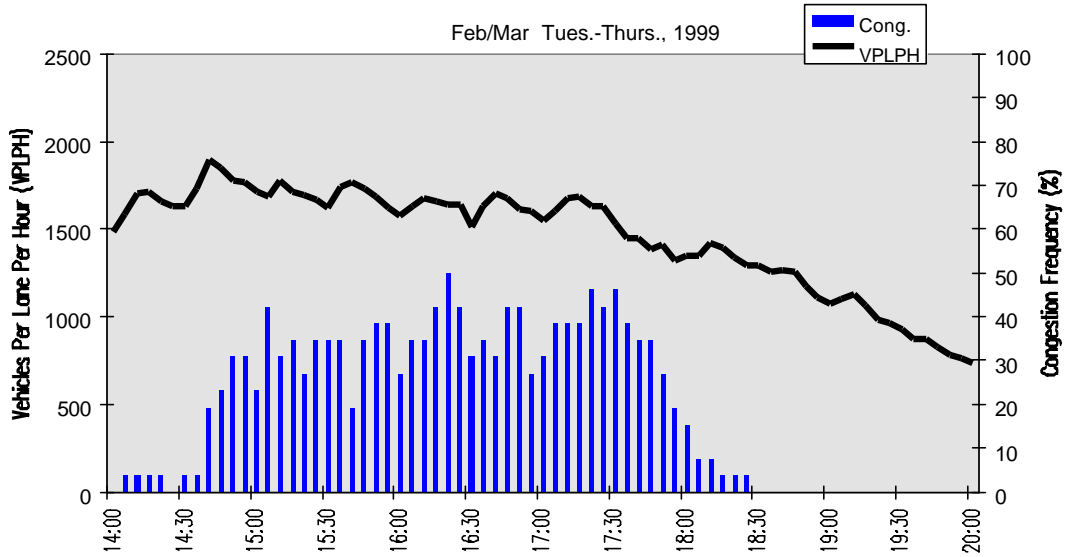


Figure 21: Breakdown Frequency of ES-322D: MS Stn

## Estimated Weekday Volume, Speed, and Reliability

SR-167 84th Ave S - GP SB

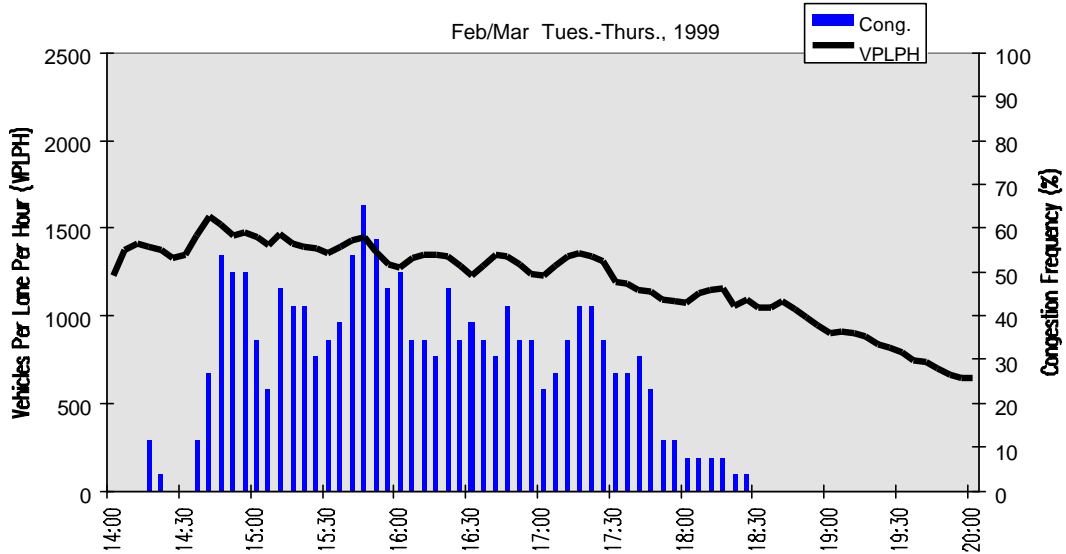


Figure 22: Breakdown Frequency of ES-324D: MS Stn

located downstream of the merge rather than upstream of the merge, this indicates a fair amount of weaving between lanes. ES-314D:\_MS\_Stn best represents the bottleneck caused by the merge and should be included as a bottleneck input.

In Figure 17 and Figure 18, we can see that the congestion drops at ES-315R:MMS\_Stn, then increases again at ES-317D:\_MS\_Stn. With an increase in breakdown frequency and mainline volumes between these stations, it appears that the bottleneck at ES-317D:\_MS\_Stn is caused by backup from the exit at S 277<sup>th</sup> St. The histograms show that, with the low congestion between ES-314D:\_MS\_Stn and ES-317D:\_MS\_Stn, the bottleneck caused by exiting vehicles is distinct from the one caused by entering vehicles.

Between ES-317D:\_MS\_Stn and ES-319D:\_MS\_Stn (Figure 19), the congestion continues to increase. The additional congestion at ES-319D:\_MS\_Stn is caused by cross-over weaving between vehicles entering at SR 516 and vehicles exiting at S 277 St. Because this station has higher breakdown frequencies than the one downstream of it, it is a distinct bottleneck from ES-317D:\_MS\_Stn: they should both be included as bottleneck inputs. Upstream of this bottleneck, the breakdown histograms are diminishing versions of the original bottleneck at ES-319D:\_MS\_Stn, so they do not need to be included as inputs.

Notice how much information about the traffic characteristics of a corridor can be deduced simply from studying the patterns of breakdown histograms. We know which on-ramps and off-ramps are problematic, what time mainline congestion peaks, where crossover weaves occur, and the distance of the backup from each bottleneck. For this corridor, our distinct bottleneck stations consist of ES-310R:MMS\_Stn, ES-314D:\_MS\_Stn, ES-317D:\_MS\_Stn, and ES-319D:\_MS\_Stn. The downstream input in the ramp metering equations at S 277<sup>th</sup> St, SR 526, and 84<sup>th</sup> Ave S include the bottleneck stations that are downstream of each ramp because those are the bottlenecks that the ramp meter can mitigate.

$$ES-315R:MMS\_FM1 = ES-315R:MMS\_Stn \mid ES-314D:_MS\_Stn \&$$

ES-310R:\_MS\_Stn | ES-317D:\_MS\_Stn | ES-315R:\_MS\_Q\_1(2) |  
 ES-315R:\_MSRA\_1(2)  
 ES-320R:MMS\_FM1 = ES-320R:MMS\_Stn | ES-319D:\_MS\_Stn &  
 ES-314D:\_MS\_Stn & ES-310R:\_MS\_Stn & ES-317D:\_MS\_Stn |  
 ES-322D:\_MS\_Stn | ES-320R:\_MS\_Q\_1(1) & ES-320R:\_MS\_Q\_2(1) |  
 ES-320R:\_MSRA\_1(1) & ES-320R:\_MSRA\_2(1)  
 ES-320R:MMS\_FM2 = ES-320R:MMS\_Stn | ES-319D:\_MS\_Stn &  
 ES-314D:\_MS\_Stn & ES-310R:\_MS\_Stn & ES-317D:\_MS\_Stn |  
 ES-322D:\_MS\_Stn | ES-320R:\_MS\_Q\_1(1) & ES-320R:\_MS\_Q\_2(1) |  
 ES-320R:\_MSRA\_1(1) & ES-320R:\_MSRA\_2(1)  
 ES-325R:MMS\_FM1 = ES-325R:MMS\_Stn | ES-319D:\_MS\_Stn &  
 ES-317D:\_MS\_Stn & ES-314D:\_MS\_Stn & ES-310R:\_MS\_Stn |  
 ES-327D:\_MS\_Stn | ES-325R:\_MS\_Q\_1(1) | ES-325R:\_MS\_Q\_1(3)

After determining the bottleneck station, next consider incident coverage. Ask, “If an incident occurred here, how long would it take before one of the bottleneck stations would detect it?” Generally, if the chosen bottleneck stations skip over more than four km or so, add an additional station to cover this section in the event of an incident. The more congested the section, the greater the likelihood and effect of an incident. Thus, more congested corridors need better incident coverage.

If a ramp meter has only one downstream bottleneck station, it is a good idea to include one additional downstream station as well, in the event that the primary bottleneck has bad data. Because the maximum bottleneck occupancy is the one used at any given instance, the controller performance does not degrade with more stations. However, the less extraneous bottleneck stations given, the more information the fuzzy equation tells the user about the corridor. By looking at a well-written, minimal fuzzy metering equation, the user can immediately see which locations downstream of that ramp are problematic. For

the SB 167 equations, we did not need to include any additional stations to handle incidents or bad data.

### **Upstream Input**

The upstream input is used as a substitute for the local input when no good data are available. This input should be the next mainline station upstream of the local station.

### **Queue Input**

Placement of the loop detectors on the ramp queues is critical to the behavior of ramp metering. The nature of queue occupancies is that they are either very low or very high. The occupancy is low (typically less than 8 percent) when the queue has not reached the detector, and it is very high when the queue has passed the detector (typically greater than 60 percent). Under most conditions, fuzzy metering tends to maintain the queue between the queue loop and the advance queue loop. We can specify whichever loops we want to use for these inputs, such as both adjacent lanes, intermediate queue loops, right hand turns, and left hand turns. Ideally, we utilize available ramp storage without making vehicles wait an excessive period to get on the mainline.

To some extent, ramp queues are only as good as detector placement and detector data. The queue input should specify the detector(s) on the metered ramp located where we want queue response to begin, immediately followed by the number of samples used to calculate the input. For most ramps, two samples (40-second data) are effective for both the queue and advance queue loops. The queue input typically uses loops of queue type ('Q\_1' and/or 'Q\_2') or intermediate queue type ('I\_1' and/or 'I\_2). Where intermediate queue loops are available in addition to advance queue detectors, use the intermediate detectors as the queue input if you want to utilize more of the ramp storage. For example, WSDOT utilizes more of the ramp storage available at SR 599 to SB I5 by using the intermediate detector instead of the queue detector in the following equation:

$$ES-070R:MMS\_FM1 = ES-070R:MMS\_Stn | ES-057D:MS\_Stn \&$$



ES-055D:\_MS\_Stn | ES-074D:\_MS\_Stn | ES-070R:\_MS\_I\_1(2) |  
 ES-070R:\_MSRA\_1(2) | ES-070R:\_MSHP\_1(50)

If the ramp has high peak volume relative to its available storage, use the queue type detectors for more preventative control that allows a bigger buffer for the next platoon of vehicles. The queue input is for preventative queue control, while the advance queue input is located at the maximum allowable queue length.

If two lanes are metered adjacent to each other where vehicles in the queue can change lanes, include both queue detectors as the queue input. Using the ‘&’ between loops tells the controller to average this occupancy data together to calculate the queue input, as in the following equations for NE 205<sup>th</sup> Street to SB I-5. Notice that these equations are identical except for the lane number to be metered. With identical equations, the metering rates calculated for these ramp meters will be identical.

ES-181R:\_MS\_FM1 = ES-181R:MMS\_Stn | ES-165D:\_MS\_Stn &  
 ES-170D:\_MS\_Stn & ES-179D:\_MS\_Stn | ES-182R:MMS\_Stn |  
 ES-181R:\_MS\_Q\_1(1) & ES-181R:\_MS\_Q\_2(1) |  
 ES-181R:\_MSRA\_1(2) & ES-181R:\_MSRA\_2(2) | ES-181R:\_MSHP\_2(25)

ES-181R:\_MS\_FM2 = ES-181R:MMS\_Stn | ES-165D:\_MS\_Stn &  
 ES-170D:\_MS\_Stn & ES-179D:\_MS\_Stn | ES-182R:MMS\_Stn |  
 ES-181R:\_MS\_Q\_1(1) & ES-181R:\_MS\_Q\_2(1) |  
 ES-181R:\_MSRA\_1(2) & ES-181R:\_MSRA\_2(2) | ES-181R:\_MSHP\_2(25)

In general, it is *not* a good idea to average together two loops that are not adjacent to each other for the queue input, such as a ‘Q\_1’ and an ‘I\_1’ loop. As with the local input, the placement of one set of detectors is better than any others. There is an optimal distance from the stop bar for the detector placement, and the loops with the best proximity to this distance should be used. Because of the binary nature of queue occupancy data (the queue has either reached the detector or has not), averaging two non-adjacent detectors does not produce more meaningful data. For example, suppose a queue type loops reads

60 percent occupancy (the queue has reached this detector), and the intermediate queue loop reads 8 percent occupancy (the queue has not reached this detector). The average here is 34 percent occupancy. With or without averaging in the intermediate data with the queue data, the controller interprets this occupancy as very big. When using non-adjacent detectors for the queue input, the average can effectively be thought of as an ‘OR’ statement. The controller utilizes the ramp storage better when the intermediate queue loop alone is used as the input.

If the lane is metered independently from other lanes (the merge with other lanes is after the stop bar), only put the queue loop that feeds that lane in the equation, such as in the following equations for 224/236<sup>th</sup> Street to SB I-5. These equations use the same mainline inputs because both lanes enter the mainline at the same place, but they have different queue characteristics, and consequently, different metering rates.

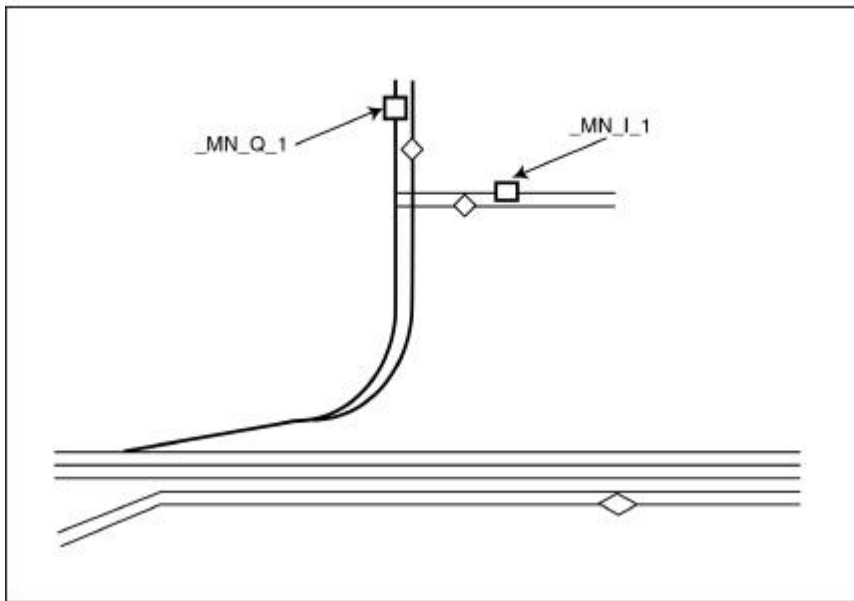
$$\begin{aligned}
 \text{ES-182R:}_{\text{MS\_FM1}} &= \text{ES-181R:MMS\_Stn} \mid \text{ES-165D:}_{\text{MS\_Stn}} \& \\
 &\text{ES-170D:}_{\text{MS\_Stn}} \& \text{ES-179D:}_{\text{MS\_Stn}} \mid \text{ES-182R:MMS\_Stn} \mid \\
 &\text{ES-182R:}_{\text{MS\_Q\_1(2)}} \mid \text{ES-182R:}_{\text{MSRA\_1(1)}} \mid \text{ES-182R:}_{\text{MSHP\_2(25)}} \\
 \text{ES-182R:}_{\text{MS\_FM2}} &= \text{ES-181R:MMS\_Stn} \mid \text{ES-165D:}_{\text{MS\_Stn}} \& \\
 &\text{ES-170D:}_{\text{MS\_Stn}} \& \text{ES-179D:}_{\text{MS\_Stn}} \mid \text{ES-182R:MMS\_Stn} \mid \\
 &\text{ES-182R:}_{\text{MS\_Q\_2(2)}} \mid \text{ES-182R:}_{\text{MSRA\_2(1)}} \mid \text{ES-182R:}_{\text{MSHP\_2(25)}}
 \end{aligned}$$

Detector location should not be assumed from the detector names. Detector naming schemes and detector locations vary considerably from one ramp to the next. For naming schemes that look unusual or for ramps that are high volume relative to the available storage, it is a good idea to determine where the detectors are located before writing the equations. One way to pinpoint detector locations is with the SC&DI schematics. Another way is to use the CCTV (closed circuit television) to find the cut marks on the ramp where the detector is installed. A third way is to watch both the queue on the CCTV and the queue data. When the given loop jumps from low to high occupancy, look where the camera shows the queue to be. Keep in mind that there is a 20 to 40-second delay between what

you see on the camera and when the TMS receives the data. If equations are written without determining queue detector locations, be sure to observe the controller in action upon initial implementation to make sure it maintains the proper queue. (This should be done anyway.)

An example of a ramp with loops that are not located where one might expect is NE 107<sup>th</sup> Street to SB I-5. Here the intermediate queue loop is not upstream of the queue loop (Figure 23). Instead, two lanes merge together before metering, and one loop is in each lane. There are no advance queue detectors, so the same detectors are reused for the advance queue input in the following equation:

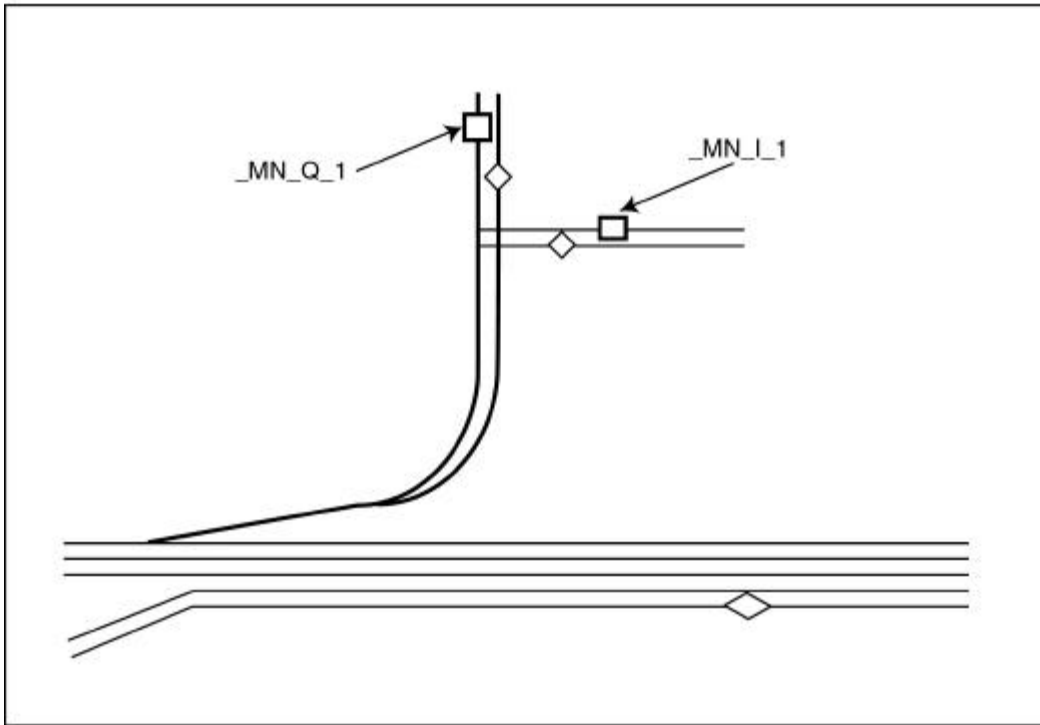
$$\begin{aligned}
 \text{ES-156R:MMS\_FM1} = & \text{ES-156R:MMS\_Stn} \mid \text{ES-118R:MS\_Stn} \ \& \\
 & \text{ES-128D:MS\_Stn} \ \& \text{ES-130D:MS\_Stn} \ \& \text{ES-136R:MMS\_Stn} \ \& \\
 & \text{ES-141R:MMS\_Stn} \ \& \text{ES-143D:MS\_Stn} \ \& \text{ES-145D:MS\_Stn} \ \& \\
 & \text{ES-149R:MMS\_Stn} \mid \text{ES-161D:MS\_Stn} \mid \text{ES-156R:CS\_Q\_1(1)} \ \& \\
 & \text{ES-156R:CS\_I\_1(1)} \mid \text{ES-156R:CS\_Q\_1(3)} \ \& \text{ES-156R:CS\_I\_1(3)} \mid \\
 & \text{ES-156R:CSHP\_1(50)}
 \end{aligned}$$



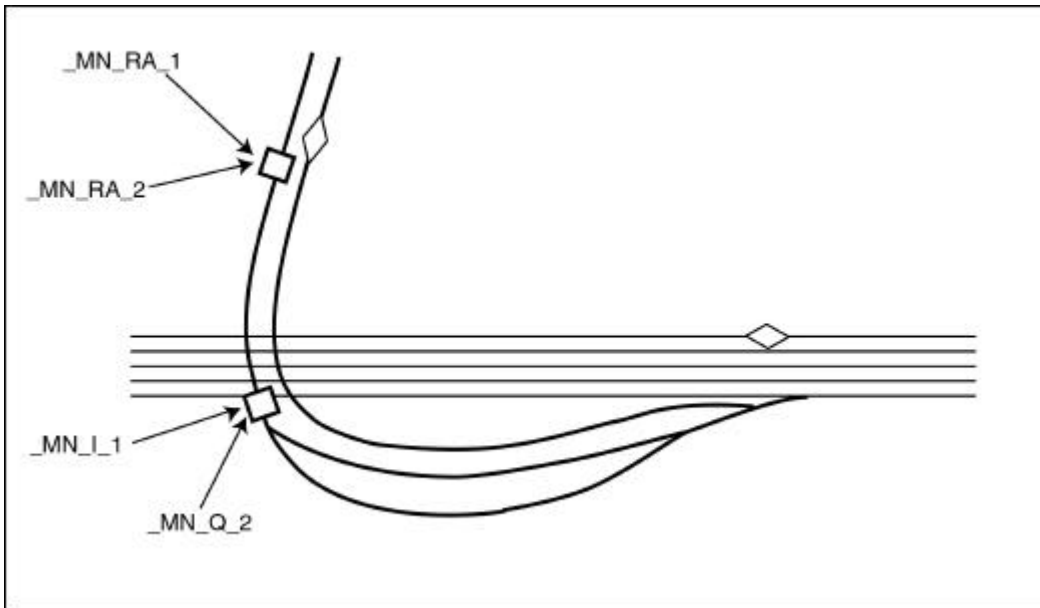
**Figure 23: Detector Placement of NE 107<sup>th</sup> St to SB I-5**

Another ramp with an unusual loop configuration is Michigan Street to NB I-5. The one lane that passes over I-5 splits into two lanes to allow for more queue storage (Figure 25). There are two detectors on the ramp before the lane splits. The queue detector is connected to two pins -- “\_MN\_I\_1” and “\_MN\_Q\_2”. Thus, these loops have identical data from one detector. Likewise, the advance queue detector is connected to two pins -- “\_MNRA\_1” and “\_MNRA\_2” and do not have unique data. For this reason, both lanes 1 and 2 use the same detectors in the equations below:

$$\begin{aligned}
 \text{ES-087R:MMN\_FM1} &= \text{ES-087R:MMN\_Stn} | \text{ES-088D:MN\_Stn} \& \\
 &\text{ES-093D:MN\_Stn} \& \text{ES-094R:MMN\_Stn} \& \text{ES-104D:MN\_Stn} | \\
 &\text{ES-086R:MMN\_Stn} | \text{ES-087R:MN\_I\_1(2)} | \text{ES-087R:MNRA\_1(2)} | \\
 &\text{ES-087R:MNHP\_2(25)} \\
 \text{ES-087R:MMN\_FM2} &= \text{ES-087R:MMN\_Stn} | \text{ES-088D:MN\_Stn} \& \\
 &\text{ES-093D:MN\_Stn} \& \text{ES-094R:MMN\_Stn} \& \text{ES-104D:MN\_Stn} | \\
 &\text{ES-086R:MMN\_Stn} | \text{ES-087R:MN\_I\_1(2)} | \text{ES-087R:MNRA\_1(2)} | \\
 &\text{ES-087R:MNHP\_2(25)}
 \end{aligned}$$



**Figure 24: Loop Detector Placement for Northgate to SB I-5**

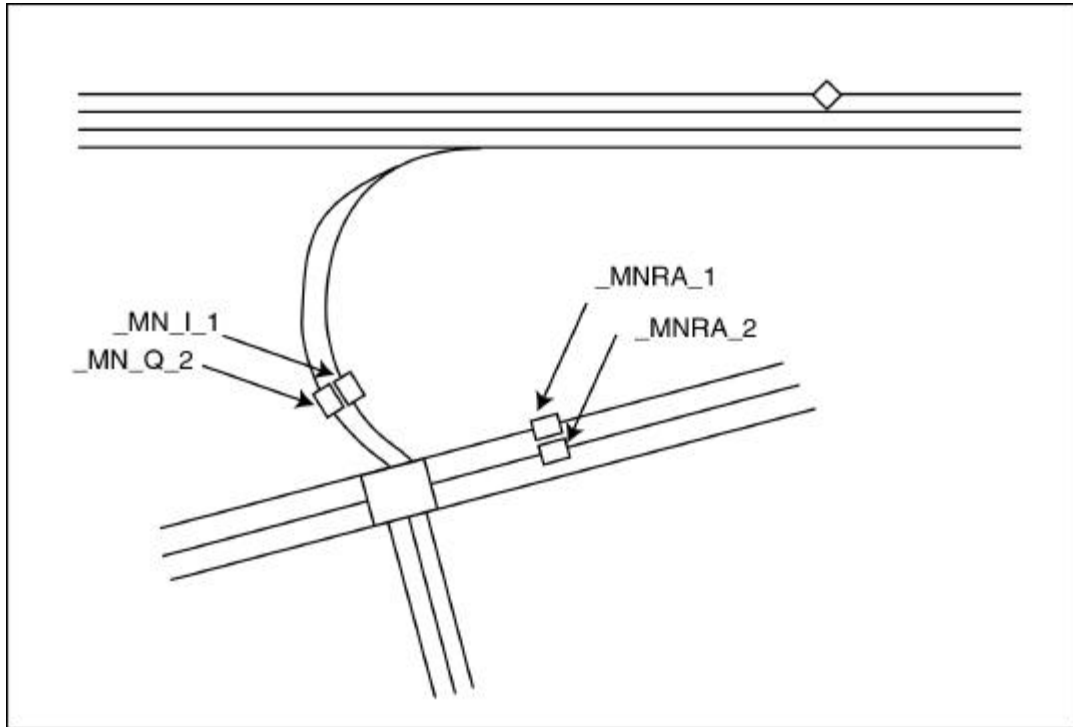


**Figure 25: Loop Detector Placement for Michigan to NB I-5**

Alderwood Parkway to NB I-5 is unique as well (Figure 26). Loop ‘\_MN\_RA\_1’ is located on the arterial in a devoted right hand turn lane. This loop is used as the advance loop detector for both metered lanes. Two loops, ‘\_MNRA\_2’ and ‘\_MN\_I\_1,’ are adjacent to each other near the entrance to the ramp and are used as the queue inputs in the following equations. In order to utilize more of the ramp storage, the queue loops are not used.

$$\begin{aligned}
 \text{ES-199R:MMN\_FM1} &= \text{ES-199R:MMN\_Stn} \mid \text{ES-205D:MN\_Stn} \ \& \\
 &\text{ES-212D:MN\_Stn} \ \& \text{ES-216D:MN\_Stn} \ \& \text{ES-222D:MN\_Stn} \ \mid \\
 &\text{ES-196D:MN\_Stn} \ \mid \text{ES-199R:MN\_I\_1(1)} \ \& \text{ES-199R:MNRA\_2(1)} \ \mid \\
 &\text{ES-199R:MNRA\_1(2)}
 \end{aligned}$$

$$\begin{aligned}
 \text{ES-199R:MMN\_FM2} &= \text{ES-199R:MMN\_Stn} \mid \text{ES-205D:MN\_Stn} \ \& \\
 &\text{ES-212D:MN\_Stn} \ \& \text{ES-216D:MN\_Stn} \ \& \text{ES-222D:MN\_Stn} \ \mid \\
 &\text{ES-196D:MN\_Stn} \ \mid \text{ES-199R:MN\_I\_1(1)} \ \& \text{ES-199R:MNRA\_2(1)} \ \mid \\
 &\text{ES-199R:MNRA\_1(2)}
 \end{aligned}$$



**Figure 26: Loop Detector Placement for Alderwood to NB I-5**

### **Advance Queue Input**

An ideal situation is where an advance or intermediate queue detector is located at the desired ramp queue end. This ideal detector is located far enough downstream of the ramp entrance to allow room for a platoon dump from the arterial signal that feeds the ramp. This way, when the metering algorithm maintains the queue just short of the advance detector, there is still sufficient room for the platoon dump from the left hand turn of the arterial signal. More commonly, advance queue detectors are located at the very end of the available ramp storage. By the time these detectors read high occupancy, the queue formation is too excessive. For this reason, the advance queue response is stronger for problematic ramps. (See the Tuning section.) For the advance queue input, choose the detector(s) located closest to the ramp queue should end when there is heavy congestion but no secondary queue.

Like the queue input, the advance queue input can use a combination of loops. Start with all advance queue loops that feed that ramp. Some ramps have both right and left hand turn loops, such as 220<sup>th</sup> Street to NB I-5.

ES-188R:MMN\_FM1 = ES-188R:MMN\_Stn | ES-205D:\_MN\_Stn &  
ES-212D:\_MN\_Stn & ES-216D:\_MN\_Stn & ES-222D:\_MN\_Stn |  
ES-186D:\_MN\_Stn | ES-188R:\_MN\_Q\_1(1) & ES-188R:\_MN\_Q\_2(1) |  
ES-188R:\_MNRA\_1(1) & ES-188R:\_MNLA\_1(1) & ES-188R:\_MNRA\_2(1) |  
ES-188R:\_MNHP\_2(35)

ES-188R:MMN\_FM2 = ES-188R:MMN\_Stn | ES-205D:\_MN\_Stn &  
ES-212D:\_MN\_Stn & ES-216D:\_MN\_Stn & ES-222D:\_MN\_Stn |  
ES-186D:\_MN\_Stn | ES-188R:\_MN\_Q\_1(1) & ES-188R:\_MN\_Q\_2(1) |  
ES-188R:\_MNRA\_1(1) & ES-188R:\_MNLA\_1(1) & ES-188R:\_MNRA\_2(1) |  
ES-188R:\_MNHP\_2(35)

Again, do not presume detector location from the detector name. A loop called 'RA\_2' can be in the right hand turn lane of the arterial, left hand turn of the arterial, or on the ramp itself. For the previous example of NE 205<sup>th</sup> Street to SB I-5, ES-181R:\_MSRA\_1 and ES-181R:\_MSRA\_2 are adjacent loops on the arterial at the ramp entrance, and both feed lanes 1 and 2. For the previous example of 224/236<sup>th</sup> Street to SB I-5, the two lanes are metered independently (no weaving between them), so lane 1 uses its respective advance queue detector, ES-182R:\_MSRA\_1, and lane 2 uses its advance queue detector, ES-182R:\_MSRA\_2. For the previous example of Alderwood Parkway to NB I-5, ES-199R:\_MNRA\_2 adjacent to ES-199R:\_MN\_I\_1 acts as an intermediate loop detector on the ramp, while ES-199R:\_MNRA\_1 is used as the advance queue input on the devoted turn lane of the arterial, feeding both lanes 1 and 2.

For ramps that do not have any appropriate advance queue detectors, reuse the queue loop(s) as the advance queue input. NE 110<sup>th</sup> St to SB I-5 is an example of this.



$$\begin{aligned}
 & \text{ES-158R:MMS\_FM1} = \text{ES-156R:MMS\_Stn} \mid \text{ES-118R:MS\_Stn} \& \\
 & \text{ES-128D:MS\_Stn} \& \text{ES-130D:MS\_Stn} \& \text{ES-136R:MMS\_Stn} \& \\
 & \text{ES-141R:MMS\_Stn} \& \text{ES-143D:MS\_Stn} \& \text{ES-145D:MS\_Stn} \& \\
 & \text{ES-149R:MMS\_Stn} \mid \text{ES-161D:MS\_Stn} \mid \text{ES-158R:CS\_Q\_1(1)} \mid \\
 & \text{ES-158R:CS\_Q\_1(3)}
 \end{aligned}$$

Notice that the number of samples used for the queue and advance queue inputs is different in this case. This technique is used to increase the frequency of an active queue response. Because traffic data are oscillatory, sometimes the queue occupancy only briefly activates a sample. At other times, perhaps the current sample is low occupancy, but the previous two samples were high occupancy. In this case, the 20-second data will read low occupancy, but the 1-minute data will read high occupancy. Using two smoothing windows for the same loop (the past number of samples used to calculate the input) effectively calculates the OR between these two conditions.

### **HOV Bypass**

If an HOV bypass lane merges with a metered lane before entering the mainline, the equation for that lane should include that HOV passage loop as an HOV input. The idea is that the metering rate should take into account the mainline merge, which is affected by any other vehicles that merge with that lane. Often, more than one lane will be affected by an HOV bypass. For instance, NE 124<sup>th</sup> Street to SB I-405 has an HOV bypass adjacent to lane 2. Lanes 1 and 2 are metered together, and the bypass should obviously affect both of these lanes. Although lane 3 is metered independently from these two lanes, lane 3 should be affected by the HOV as well, because all lanes merge together before entering the mainline. In these equations, lanes 1 and 2 each handle 20 percent of the HOV adjustment, and lane 3 handles 10 percent of the HOV adjustment.

ES-730R:MMS\_FM1 = ES-730R:MMS\_Stn | ES-709D:\_MS\_Stn &  
 ES-722D:\_MS\_Stn & ES-724D:\_MS\_Stn | ES-731R:\_MS\_Stn |  
 ES-730R:\_MS\_Q\_1(1) & ES-730R:\_MS\_Q\_2(1) | ES-730R:\_MSRA\_1(1) |  
 ES-730R:\_MSHP\_2(20)

ES-730R:MMS\_FM2 = ES-730R:MMS\_Stn | ES-709D:\_MS\_Stn &  
 ES-722D:\_MS\_Stn & ES-724D:\_MS\_Stn | ES-731R:\_MS\_Stn |  
 ES-730R:\_MS\_Q\_1(1) & ES-730R:\_MS\_Q\_2(1) | ES-730R:\_MSRA\_1(1) |  
 ES-730R:\_MSHP\_2(20)

ES-730R:MMS\_FM3 = ES-730R:MMS\_Stn | ES-709D:\_MS\_Stn &  
 ES-722D:\_MS\_Stn & ES-724D:\_MS\_Stn | ES-731R:\_MS\_Stn |  
 ES-730R:\_MS\_Q\_3(1) | ES-730R:\_MSRA\_3(4) | ES-730R:\_MSHP\_2(10)

Notice the total percentage of HOV bypass applied is not 100 percent. It does not need to be. For each lane, the HOV adjustment can be between 0 and 100 percent. An HOV bypass could cause anywhere from no effect to triple the effect (if all three lanes are at 100 percent). Most commonly, the percentage of HOV bypass applied across all lanes totals 50 percent or so. If the percentage of HOV bypass is too high, the metering rate will be too restrictive, aggravating drivers to violate the signals. (See Introduction.) A higher percentage of HOV bypass should be applied in two situations: 1) the mainline merge is so congested that there is a tendency for secondary queue formation, and 2) the ramp has adequate storage relative to its peak demand. Another trick is to redistribute the percentages to apply more HOV adjustment to the lane that can handle more vehicles in its ramp queue, even though the HOVs are not coming from the direction of that ramp. Although the percentage of HOV bypass applied can be used to tune the metering rate if it is too high or too low during peak periods, there are more direct ways of tuning the metering rate. (See Tuning section.) This parameter is rarely tuned after initial implementation.

## TUNING

This section first describes the parameters available for tuning the algorithm. Next, the procedure for optimization is described, followed by a series of examples of how to solve various problems.

### ***Parameters for Tuning***

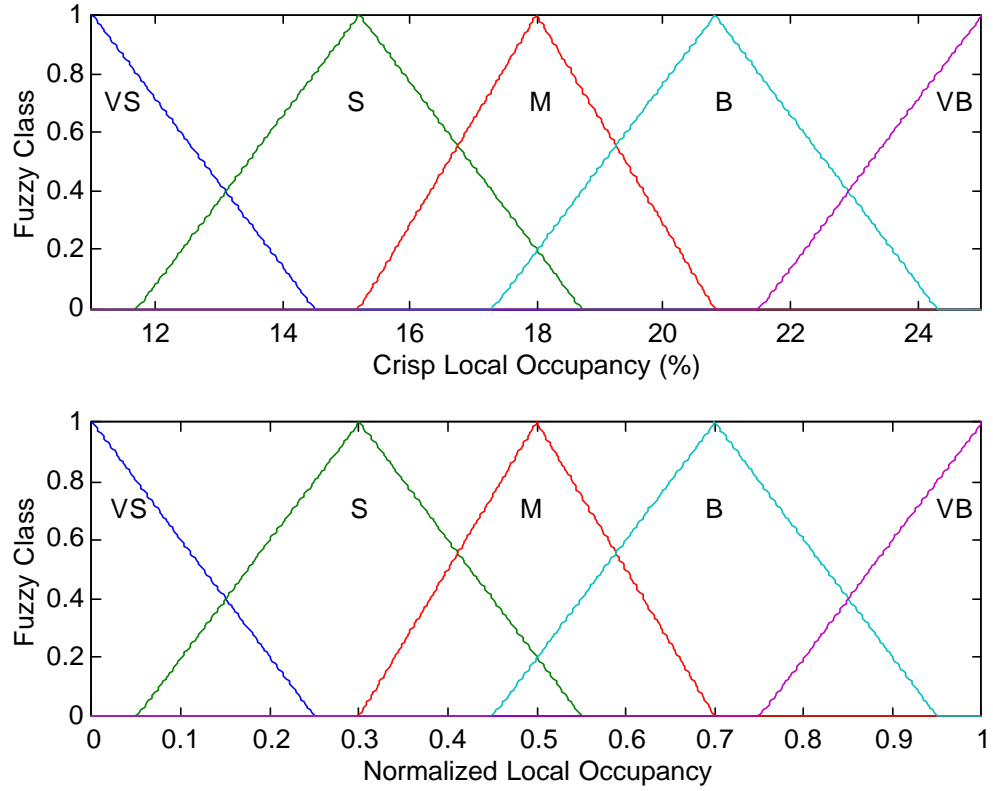
There are two types of fuzzy metering parameters, dynamic range limits and rule weights. The dynamic range parameters affect controller behavior by defining the linguistic variables. The rule weights affect controller behavior by defining the relative importance of each rule. Rule weights can be thought of as the way to balance objective priorities. Fuzzy parameters can be tuned in real time through the TMS software. To make a change that will persist beyond a database rebuild, enter the change into the *rmdb\_input.fil* under the group name called “Fuzzymeter\_Parameters.”

Two dynamic range parameters, a low and a high, are associated with each input and output of the fuzzy logic ramp metering algorithm. Essentially, these dynamic range parameters can be adjusted to redefine “very big occupancy”, “small speed”, “medium metering rate”, etc. Adjusting these parameters changes the shape and range of the fuzzy class, which in turn alters the behavior of the controller. Two scaling parameters set the low limit (*LL*) and high limit (*HL*) for the *dynamic* control range of each variable.

Within the fuzzification module of the controller, the following scaling equation normalizes the crisp variables from the (*LL*, *HL*) range to the (0,1) range:

$$scaled\ crisp\ variable = \frac{crisp\ variable - LL}{HL - LL}$$

Figure 27 demonstrates this process. The top figure shows the fuzzy classes applicable to the outside world, and the bottom figure shows the normalized fuzzy classes used inside the controller. The scaling simplifies the code by allowing all variables to use the same software modules for easy computation, as well as allowing easy class modification.



**Figure 27. Crisp and Normalized Fuzzy Classes**

Each of the five fuzzy classes shown in Figure 27 is described by a function  $f_i(x)$ , where  $C_i$  is the centroid,  $\mathbf{b}_i$  is the base width, and the  $i$  subscript denotes the class. The S, M, and B classes are defined by an isosceles triangle with a base of  $2\mathbf{b}_i$  and unitary height. The triangle is centered at  $C_i$  and has slopes of  $\pm\frac{1}{\mathbf{b}_i}$ . The resulting membership degrees are calculated from the scaled crisp input,  $x$ , according to

$$f_i(x) = \begin{cases} \frac{1}{\mathbf{b}_i}(x - C_i + \mathbf{b}_i) & \text{for } C_i - \mathbf{b}_i < x < C_i \\ -\frac{1}{\mathbf{b}_i}(x - C_i - \mathbf{b}_i) & \text{for } C_i < x < C_i + \mathbf{b}_i \end{cases}$$

For all classes,  $f_i(x) = 0$  unless otherwise noted. A right triangle defines VS and VB. For VS, the peak is at 0, so  $C_i$  is  $\frac{\mathbf{b}_i}{3}$ . The class is 1 if  $x$  is less than 0.

For VS,

$$f_i(x) = \begin{cases} 1 & \text{for } x < 0 \\ -\frac{1}{\mathbf{b}_i}(x - \mathbf{b}_i) & \text{for } 0 < x < \mathbf{b}_i \end{cases}$$

For VB, the peak is at 1, so  $C_i$  is  $1 - \frac{\mathbf{b}_i}{3}$ . The class is 1 if  $x$  is greater than 1. For

VB,

$$f_i(x) = \begin{cases} \frac{1}{\mathbf{b}_i}(x - 1 + \mathbf{b}_i) & \text{for } 1 - \mathbf{b}_i < x < 1 \\ 1 & \text{for } x > 1 \end{cases}$$

In summary, the low and high parameters are tunable in real time. They define the dynamic range of the fuzzy classes, which the controller uses to normalize the fuzzy classes. Within the normalized fuzzy classes,  $\beta_i$  is the base width, and  $C_i$  is the centroid of each class. The relative base width and centroid are not tunable in real time because we found during on-line testing that there is no need to tune these. Adjusting the dynamic range of the inputs was sufficient to achieve any of the control that we desired. This means that although the range and shape of the classes can be altered, the *relative* widths and *relative* positioning of the classes can not. If you find that you need to change these, see “A Programmer’s Guide to the Fuzzy Logic Ramp Metering Algorithm,” (Taylor and Meldrum, 2000).

For inputs that utilize all five fuzzy classes, the system-wide base width and centroids for each normalized class are defined as follows:  $\beta = [0.25, 0.25, 0.2, 0.25, 0.25]$  and  $C = [1/3*\beta_1, 0.3, 0.5, 0.7, 1-1/3*\beta_5]$ . For inputs that only use the VB class,  $\beta_5$  is 1. For classes that only use the VS class,  $\beta_1$  is 1. Using the system-wide parameter defaults for each input, figures 1-4 show the definitions of the fuzzy classes.

Table 5 lists each fuzzy metering parameter that is tunable in real time. The table contains a brief description of the parameter, the data type in the RMDB, the units used, the minimum allowable value, the maximum allowable value, the system-wide default value, and an example of how to enter this parameter into the *rmdb\_input.fil*. Notice that the elements of data type USHORT1P (unsigned short with one decimal place, in percentage) must have a percent sign immediately after the tenths place. Elements of data type USHORT1 (unsigned short with one decimal place) must have a tenths place, as must UBYTE1 elements (unsigned byte with one decimal place). An error will occur during the RMDB rebuild if any of the following occur: 1) the element name is incorrect, 2) the formatting is incorrect, or 3) the value is outside of the allowable range.

By running *test\_rmdb.exe* before the actual rebuild of RMDB, any errors can be identified and corrected beforehand, preventing system down time. (Again, CMS does this for you.) As with the fuzzy equations, errors in the fuzzy parameters do not cause software failure. If an error occurs, the message is sent to *mon\_event\_log* process and to *rmdb\_error.fil*. If the user does not choose to correct it and rebuild RMDB again, the system will proceed with start-up and operations, except that the parameter value will remain unchanged from its previous default.

**Table 5. Fuzzy Metering Parameters**

NAME	DESCRIPTION	CODING	UNIT	MIN	MAX	DEFAULT	EXAMPLE
AdvQueueOccHigh1	High end of dynamic range for Advance Queue Occ, lane 1	USHORT1P	%	0.0%	100.0%	30.0%	AdvQueueOccHigh1 = 30.0%
AdvQueueOccHigh2	High end of dynamic range for Advance Queue Occ, lane 2	USHORT1P	%	0.0%	100.0%	30.0%	AdvQueueOccHigh2 = 30.0%
AdvQueueOccHigh3	High end of dynamic range for Advance Queue Occ, lane 3	USHORT1P	%	0.0%	100.0%	30.0%	AdvQueueOccHigh3 = 30.0%
AdvQueueOccLow1	Low end of dynamic range for Advance Queue Occ, lane 1	USHORT1P	%	0.0%	100.0%	12.0%	AdvQueueOccLow1 = 12.0%
AdvQueueOccLow2	Low end of dynamic range for Advance Queue Occ, lane 2	USHORT1P	%	0.0%	100.0%	12.0%	AdvQueueOccLow2 = 12.0%
AdvQueueOccLow3	Low end of dynamic range for Advance Queue Occ, lane 3	USHORT1P	%	0.0%	100.0%	12.0%	AdvQueueOccLow3 = 12.0%
AdvQueueOccWt1	Weight for Adv Queue Occupancy Rule, lane 1	UBYTE1	N/A	0.0	25.5	4.0	AdvQueueOccWt1 = 4.0
AdvQueueOccWt2	Weight for Adv Queue Occupancy Rule, lane 2	UBYTE1	N/A	0.0	25.5	4.0	AdvQueueOccWt2 = 4.0
AdvQueueOccWt3	Weight for Adv Queue Occupancy Rule, lane 3	UBYTE1	N/A	0.0	25.5	4.0	AdvQueueOccWt3 = 4.0
DownOccHigh	High end of dynamic range for Downstream Occupancy	USHORT1P	%	0.0%	100.0%	25.0%	DownOccHigh = 25.0%
DownOccLow	Low end of dynamic range for Downstream Occupancy	USHORT1P	%	0.0%	100.0%	11.0%	DownOccLow = 11.0%
DownSpeedHigh	High end of dynamic range for Downstream Speed	USHORT1	MPH	0.0	100.0	55.0	DownSpeedHigh = 55.0
DownSpeedLow	Low end of dynamic range for Downstream Speed	USHORT1	MPH	0.0	100.0	40.0	DownSpeedLow = 40.0
DownSpVs_OccVbWt	Weight for Very Small Speed and Very Big Occ Rule	UBYTE1	N/A	0.0	25.5	4.0	DownSpVs_OccVbWt= 4.0
NAME	DESCRIPTION	CODING	UNIT	MIN	MAX	DEFAULT	EXAMPLE

LocalOccHigh	High end of dynamic range for Local Occupancy	USHORT1P	%	0.0%	100.0%	25.0%	LocalOccHigh = 25.0%
LocalOccLow	Low end of dynamic range for Local Occupancy	USHORT1P	%	0.0%	100.0%	11.0%	LocalOccLow = 11.0%
LocalOccVbWt	Weight for Local Very Big Occupancy Rule	UBYTE1	N/A	0.1	25.5	2.5	LocalOccVbWt = 2.5
LocalOccBWt	Weight for Local Big Occupancy Rule	UBYTE1	N/A	0.1	25.5	1.0	LocalOccBWt = 1.0
LocalOccMWt	Weight for Local Medium Occupancy Rule	UBYTE1	N/A	0.1	25.5	1.0	LocalOccMWt = 1.0
LocalOccSWt	Weight for Local Small Occupancy Rule	UBYTE1	N/A	0.1	25.5	1.0	LocalOccSWt = 1.0
LocalOccVsWt	Weight for Local Very Small Occupancy Rule	UBYTE1	N/A	0.1	25.5	1.0	LocalOccVsWt = 1.0
LocalSpeedHigh	High end of dynamic range for Local Speed	USHORT1	MPH	0.0	100.0	55.0	LocalSpeedHigh = 55.0
LocalSpeedLow	Low end of dynamic range for Local Speed	USHORT1	MPH	0.0	100.0	35.0	LocalSpeedLow = 35.0
LocSpVs_OccVbWt	Weight for Local Very Small Speed and Very Big Occ Rule	UBYTE1	N/A	0.0	25.5	3.0	LocSpVs_OccVbWt = 3.0
LocalSpeedSWt	Weight for Local Small Speed Rule	UBYTE1	N/A	0.0	25.5	1.0	LocalSpeedSWt = 1.0
LocalSpeedBWt	Weight for Local Big Speed	UBYTE1	N/A	0.0	25.5	1.0	LocalSpeedBWt = 1.0
LocSpVb_OccVsWt	Weight for Local Very Big Speed and Very Small Occ Rule	UBYTE1	N/A	0.0	25.5	1.0	LocSpVb_OccVsWt = 1.0
MeterRateHigh1	High limit for metering rate produced by fuzzy controller, lane 1	UBYTE1	VPM	0.0	25.5	19.3	MeterRateHigh1 = 19.3
MeterRateHigh2	High limit for metering rate produced by fuzzy controller, lane 2	UBYTE1	VPM	0.0	25.5	19.3	MeterRateHigh2 = 19.3
MeterRateHigh3	High limit for metering rate produced by fuzzy controller, lane 3	UBYTE1	VPM	0.0	25.5	19.3	MeterRateHigh3 = 19.3
<b>NAME</b>	<b>DESCRIPTION</b>	<b>CODING</b>	<b>UNIT</b>	<b>MIN</b>	<b>MAX</b>	<b>DEFAULT</b>	<b>EXAMPLE</b>



MeterRateLow1	Low limit for metering rate produced by fuzzy controller, lane 1	UBYTE1	VPM	0.0	25.5	3.0	MeterRateLow1 = 3.0
MeterRateLow2	Low limit for metering rate produced by fuzzy controller, lane 2	UBYTE1	VPM	0.0	25.5	3.0	MeterRateLow2 = 3.0
MeterRateLow3	Low limit for metering rate produced by fuzzy controller, lane 3	UBYTE1	VPM	0.0	25.5	3.0	MeterRateLow3 = 3.0
PermitFuzzyMr1	Enable fuzzy control at this meter	YES_NO	FLAG	NO	YES	NO	PermitFuzzyMr1 = NO
PermitFuzzyMr2	Enable fuzzy control at this meter	YES_NO	FLAG	NO	YES	NO	PermitFuzzyMr2 = NO
PermitFuzzyMr3	Enable fuzzy control at this meter	YES_NO	FLAG	NO	YES	NO	PermitFuzzyMr3 = NO
QueueOccHigh1	High end of dynamic range for Queue Occupancy, lane 1	USHORT1P	%	0.0%	100.0%	30.0%	QueueOccHigh1 = 30.0%
QueueOccHigh2	High end of dynamic range for Queue Occupancy, lane 2	USHORT1P	%	0.0%	100.0%	30.0%	QueueOccHigh2 = 30.0%
QueueOccHigh3	High end of dynamic range for Queue Occupancy, lane 3	USHORT1P	%	0.0%	100.0%	30.0%	QueueOccHigh3 = 30.0%
QueueOccLow1	Low end of dynamic range for Queue Occupancy, lane 1	USHORT1P	%	0.0%	100.0%	12.0%	QueueOccLow1 = 12.0%
QueueOccLow2	Low end of dynamic range for Queue Occupancy, lane 2	USHORT1P	%	0.0%	100.0%	12.0%	QueueOccLow2 = 12.0%
QueueOccLow3	Low end of dynamic range for Queue Occupancy, lane 3	USHORT1P	%	0.0%	100.0%	12.0%	QueueOccLow3 = 12.0%
QueueOccWt1	Weight for Queue Occupancy Rule, Lane 1	UBYTE1	N/A	0.0	25.5	2.0	QueueOccWt1 = 2.0
QueueOccWt2	Weight for Queue Occupancy Rule, Lane 2	UBYTE1	N/A	0.0	25.5	2.0	QueueOccWt2 = 2.0
QueueOccWt3	Weight for Queue Occupancy Rule, Lane 3	UBYTE1	N/A	0.0	25.5	2.0	QueueOccWt3 = 2.0

## ***Procedure for Optimization***

With knowledge of the implementation site characteristics and an understanding of the algorithm, the user can tune the controller to achieve the desired behavior. The nature of a fuzzy logic controller connotes that the tuning procedure is somewhat “fuzzy.” That is, the optimization procedure is not formula based, but knowledge based. The reason relates to the difficulty in modeling the system accurately and the difficulty in obtaining the desired performance measures with accuracy. The fuzzy logic ramp metering algorithm is designed to incorporate human expertise, and consequently, the tuning procedure requires critical thinking about the system.

The examples given in this manual demonstrate how to achieve various objectives. Optimization must be done with respect to the desired performance criteria. If one user has different performance criteria than another user, they will arrive at different parameters for their optimal controller. The optimal parameters arrived at in these examples reflect the control ideology of the current TSMC management.

Inherently, ramp metering has conflicting objectives. The objective to reduce mainline congestion produces restrictive metering rates, and the objective to reduce ramp queues produces higher metering rates. Likewise, the objective of minimizing travel times may conflict with the objective of maximizing flow. Minimum travel times occur when fewer vehicles are on the freeway. Maximum flow may require more vehicles on the freeway at the expense of higher travel times, provided that flow does not break down. Maximizing the distance traveled by all vehicles in the system discourages drivers with short trips from using the freeway while providing more benefit to drivers who take longer trips. Maximizing distance traveled also mitigates downstream bottlenecks over upstream bottlenecks (because more vehicles travel through the downstream bottleneck). The goal of tuning is to achieve the proper balance among these conflicting objectives:

- maximum flow of all vehicles in the system

- minimum overall travel times
- maximum distance traveled by all vehicles in the system
- acceptable delay in the queue.

Although these are the performance objectives we would like to accomplish, we cannot directly use them because they are not easily measurable. Instead, it is much more practical to use objectives that we can observe in real time. These are summarized in Table 6. These objectives are observable in real time with CCTVs, loop detector data, the FLOW maps, and *watch\_fuzzymeter*. The best way to analyze the behavior of the controller and to tune it is through *watch\_fuzzymeter*.

The idea is that if we achieve the proper balance of these measurable objectives, the associated balance of the original objectives will be attained as well. The successful on-line test results provide evidence of this relationship (Taylor and Meldrum, 2000). Mitigating downstream bottlenecks increases flow by preventing critical flow breakdown. This is one of the primary ways in which ramp metering provides system-wide benefit. This objective is the primary determinant of the metering rate when there is no excessive ramp queue or secondary queue.

Although acceptable ramp queues may reduce delay at the ramp, they do not necessarily improve overall travel times. However, maintaining an acceptable ramp queue is a constraint that we must work within for political and safety reasons. This constraint bounds the lower rate at which we can meter during peak conditions – effectively limiting how much we can mitigate mainline congestion. Because maintaining an acceptable ramp queue is higher priority than mitigating downstream bottlenecks (for most ramps), we meter at this lower bound -- just fast enough to prevent an excessive ramp queue when there is significant mainline congestion and a maximum acceptable ramp queue but no secondary queue.

**Table 6. Control Objectives**

<b>Priority</b>	<b>Objective</b>	<b>Comment</b>	<b>Metering Rate</b>
1	Prevent secondary queue formation	When formation of a secondary queue may occur, this objective takes priority over maintaining an acceptable ramp queue.	The small metering rate at which a secondary queue is prevented during peak conditions (not necessarily the same as minimum metering rate) – bounds upper rate during this traffic condition.
2	Maintain an acceptable ramp queue (this definition varies from ramp to ramp depending on devoted turn lanes of arterial, safety of left hand turn, and local politics)	This constraint limits how much we can mitigate the downstream bottleneck.	The big metering rate at which an excessive ramp queue is prevented during peak ramp demand (not the same as the maximum metering rate) – bounds lower rate during this traffic condition.
3	Prevent or delay downstream bottleneck formation	Primary determinant of metering rate when there is no excessive queue and no secondary queue.	Lowers metering rate to prevent critical flow breakdown.

Preventing a secondary queue is another constraint on the metering rate. (A secondary queue occurs when vehicles are unable to merge onto the mainline at the metered rate because of heavy local congestion.) During heavy local congestion, this objective constrains the upper rate at which we can meter to prevent a secondary queue. Often, we set the minimum metering rate to match this (when this rate is as low as we can meter without violation). If we do not prevent a secondary queue, there is no benefit to ramp metering. For this reason, preventing a secondary queue is the top priority when the local mainline is highly congested. If a secondary queue forms, the metered vehicles are contributing to a mainline bottleneck at the merge. Because all mainline vehicles through this section are affected by this bottleneck, there is system-wide benefit to preventing a local bottleneck. Thus, the objective to prevent a secondary queue correlates with increasing mainline flow.

Most always, the upper bound of the rate that prevents a secondary queue is lower than the lower bound of the rate that prevents an excessive ramp queue during peak conditions. Because preventing a secondary queue is of higher priority than maintaining an acceptable queue, we meter at the upper bound produced by priority 1 (typically the minimum rate) when both traffic conditions are present. It is under this circumstance of heavy local congestion that the ramp queue is no longer a concern. Drivers obey this rate because they understand there is no point to metering faster than the vehicles can merge onto the mainline.

What the priorities of Table 6 tell us is that the predominant objective at a given time depends on the traffic conditions. The rule-based nature of the fuzzy logic controller implements our objective priorities, depending on the degree that the condition is true and how important the objectives are relative to each other, as indicated by the rule weights. Tuning is a matter of finding the balance point between these objectives during particular traffic patterns, and defining what the range of the metering rate classes should be. Through observation with the CCTVs and *watch\_fuzzymeter*, we can increase the metering

rate just enough to prevent an excessive queue during peak conditions – this is the lower bound for the metering rate when priority 2 dominates. If a secondary queue forms, we can reduce the metering rate just enough to prevent a secondary queue – this is the upper bound for the metering rate when priority 1 dominates. Most parameters are determined during the peak period because this is when objectives are most likely to conflict.

For instance, suppose ramp metering begins at the earliest sign of downstream congestion. The metering rate produced by the controller is 7 VPM (vehicles/minute) to mitigate the downstream bottleneck. A queue forms. By the time the queue reaches back to the advance queue detector, the metering rate has gradually increased to 12 VPM, which is the lower bound for priority 2, the metering rate at which an excessive ramp queue is prevented. Local congestion gets much worse as the mainline demand increases, and the vehicles can not quite merge as fast as they are metered. As priority 1 predominates, the metering rate reduces to 5 VPM, just low enough to prevent secondary queue formation. In this example, objective 1 is incompatible with objective 2, so objective 1 takes priority.

If the parameters are tuned so that the desired balance point for these objectives is found for all traffic patterns that apply to that ramp meter, that ramp meter is optimally tuned. For the majority of ramps in the Seattle system, the system-wide parameter defaults were optimal, and no tuning was necessary. For ramps that did require tuning, typically only a few parameters needed adjustment. Because all rule weights are relative to each other, adjusting one rule weight can change the balance point of the control objectives. In particular, the queue objectives oppose the mainline objectives. So adjusting only the queue or advance queue rule weight will often be sufficient to shift the balance point.

The algorithm design is flexible enough to encompass a broad range of situations. A knowledgeable user can obtain remarkable results in tuning the parameters to handle unusual cases. The caveat of this flexibility is that there is more than one way to accomplish a goal. For instance, suppose you know that the metering rate should be lower because a secondary queue has formed. Several parameters can lower the metering rate.

How do you know which one to use? You should choose the parameter that has the intended effect under *all* conditions, not just that particular instance. The controller should produce appropriate metering rates under all situations applicable to that ramp, encompassing when the traffic builds, peaks, and dissipates. There *is* a unique optimal solution in most cases. In other words, each parameter has a different purpose, and there is a “correct” parameter that should be tuned for a given situation. This statement is not intended to intimidate but to encourage critical thinking and to encourage evaluation of the resulting parameters over all traffic patterns. Once the optimal controller parameters have been determined, the parameters no longer need tuning (unless geometry changes or traffic patterns change considerably over time).

To tune the controller, perform these tasks, if needed, in the following order:

- 1) Edit the equations.
- 2) Tune the fuzzy input classes.
- 3) Tune the rule weights.
- 4) Tune the fuzzy metering rate classes.
- 5) Tune the minimum and maximum metering rate.

These tasks should be performed in the order of dependency. All controller values are dependent on the loops used to calculate the inputs (task 1). The degree of trueness of each fuzzy class (task 2) is dependent on the inputs used. The rules that activate and the extent of activation (task 3) are dependent on the fuzzy class degrees. The centroid of the metering rate classes is dependent on the weighting of each rule (task 3). The metering rate is dependent on the definition of the metering rate classes (task 4). The final metering rate is always bounded by the minimum and maximum allowable metering rate for that ramp (task 5).

Tuning is an iterative procedure. In general, a change in any of the above tasks affects all tasks after it, so the user should repeat all subsequent tasks. If you find that you need to make a change to an equation, tasks 2 through 4 should be repeated. If you find that

you need to retune the fuzzy classes, tune the rule weights afterwards, and so on. If you do not know which task to do first, begin with the one higher on this list. In actuality, you may skip steps in this procedure if it is obvious which parameters need to be tuned.

Along with tuning, evaluating the performance criteria is an iterative procedure. Commonly, parameters are first tuned to balance objectives during peak congestion. When parameters are not optimal at the beginning of a metering period, a problem may occur (excessive queue or secondary queue). The user naturally over-reacts in adjusting the parameters because the system takes a while to reach equilibrium following a parameter change. By the time equilibrium is reached, demand has changed. Because ramp metering mainly benefits traffic by preventing problems, it is important to observe the parameters throughout the building/peaking/dissipation cycle after a change has been made. The old adage, “an ounce of prevention is worth a pound of cure” is especially true for ramp metering. For example, parameters that were found effective to mitigate an excessive ramp queue may be overkill during the next metering cycle because the new parameters may prevent a moderate queue from forming in the first place.

In summary, be sure to observe the controller for peak demand and tune if necessary. Then observe throughout the entire cycle of traffic patterns to make sure that the parameters are optimal for preventing a problem rather than just reacting to a problem. Be sure that parameters are optimal for all traffic patterns, not just the peak period during which they were tuned.

### ***Examples of Tuning***

Table 7 is a trouble shooting guide on how to handle various tuning problems. The first column describes a problem. The second column indicates which parameter(s) may be helpful with this problem and whether the parameter should be increased or decreased. The last column describes the effect of the change.



## **Compensating for Inaccurate Data**

There are two methods for handling inaccurate data: 1) drop the offending loop from the fuzzy equation, provided that at least one other loop is available to calculate this input, or 2) redefine the linguistic variables so that the biased data maps to the correct class.

An example of method 1 is given in the Local Input section of Equation Writing. For Ravenna to SB I-5, lanes 2 and 3 were used instead of the station data, while lanes 1 and 4 read lower occupancy because of a poorly calibrated amplifier.

There are several ramps where one turn movement has much higher volumes than the other turn movement. To increase the sensitivity to the high demand turn movement, we can drop the less relevant advance queue detectors from the equation. For instance, Sunset to NB I-405 has a long queue when Boeing workers leave. Loop ES-638:\_MNLA\_2 from the left hand turn captures this queue, but ES-638R:\_MNRA\_2 from the right hand turn does not. ES-638R:\_MNRA\_2 brings down the average advance queue occupancy. The loop detector of the left hand turn lane is more by itself in this case.

If the data are consistently biased, method 2 is no problem for the fuzzy logic controller. For example, during heavy congestion, the speed estimated from loop detector data tends to read higher than the actual speed. During free flow, the estimated speed tends to read lower than the actual speed. To account for this disparity, the system-

**Table 7. Trouble Shooting Guide**

<b>Detector Placement Problems</b>	<b>Parameter Change</b>	<b>Effect</b>
Queue detector is too close to stop bar, and consequently, queue response is too strong too soon.	↑ QueueOccLow	Queue response will begin later when a more dense (longer) queue has formed. Meter Rate ↑ delayed. (Response reaches same amplitude but timing occurs later).
	↑ QueueOccHigh	Maximum queue response will not be reached until later when a denser (longer) queue has formed. Meter Rate ↑ delayed
	↓ QueueOccWt	Queue response will be diminished. Metering Rate ↓.
Queue detector is too close to the arterial. The buffer for the next platoon is the remaining storage after the queue detector, but this storage is insufficient for a platoon during peak demand.	↓ QueueOccLow	Queue response will begin sooner with less dense (shorter) queue formation. Meter Rate ↑ sooner. (Response reaches same amplitude but occurs sooner).
	↓ QueueOccHigh	Queue response will reach maximum response sooner with a less dense (shorter) queue. Meter Rate ↑ sooner.
	↑ QueueOccWt	More preventative queue response will allow more buffer for large platoons. Meter Rate ↑.

<b>Detector Placement Problems</b>	<b>Parameter Change</b>	<b>Effect</b>
Advance queue detector is too close to stop bar and does not utilize existing storage.	↑ AdvQueueOccLow	Advance queue response will begin later when a more dense (longer) queue has formed. Meter Rate ↑ delayed. (Response reaches same amplitude but timing occurs later).
	↑ AdvQueueOccHigh	Maximum advance queue response will not be reached until later when a denser (longer) queue has formed. Meter Rate ↑ delayed.
Advance queue detector is too far back. A queue maintained just short of this detector is too long because it does not allow room for the next platoon of vehicles or wait time is too long.	↓ AdvQueueOccLow	Advance queue response will begin sooner with less dense (shorter) queue formation. Meter Rate ↑ sooner. (Response reaches same amplitude but occurs sooner).
	↓ AdvQueueOccHigh	Maximum advance queue response will be reached sooner with less dense (shorter) queue. Meter Rate ↑ sooner.
	↑ AdvQueueOccWt	Advance queue response will be increased. Meter Rate ↑.

<b>Detector Placement Problems</b>	<b>Parameter Change</b>	<b>Effect</b>
Advance queue detection is oscillatory because of platooning from signal, and we would like more consistent and sensitive detection.	↓ AdvQueueOccLow in conjunction with ↑ # of samples	Advance queue response will occur more frequently and to a higher degree. Meter Rate ↑ sooner.
	↓ AdvQueueOccHigh in conjunction with ↑ # of samples	Advance queue response will occur more frequently and to a higher degree. Meter Rate ↑ sooner.

Queue Problems	Parameter Change	Effect
Queue is too short. Local merge may be problematic and/or demand is low relative to available ramp storage.	↓ QueueOccWt	Queue response will be diminished. Metering Rate ↓.
Queue is too long. Peak demand far exceeds ramp storage and queue maintenance must be more preventative before reaching advance queue detector.	↑ QueueOccWt	More preventative queue response will allow more buffer for large platoons. Meter Rate ↑.
Queue is too short during peak demand and/or preventing a secondary queue is a particular problem.	↓ AdvQueueOccWt	Advance queue response will be diminished. Metering Rate ↓
Queue is too long. Advance queue response must be stronger to prevent blocking the arterial or wait time is too long.	↑ AdvQueueOccWt	Advance queue response will be increased. Meter Rate ↑.

<b>Meter Rate Problems</b>	<b>Parameter Change</b>	<b>Effect</b>
Metering Rate must be higher in all situations. Queue storage is problematic.	↑ MeterRateHigh	Redistributes the metering rate fuzzy classes to increase the metering rate.
	↑ MeterRateLow	Redistributes the metering rate fuzzy classes to increase the metering rate. ↑ MeterRate
Meter Rate must be lower in general, for all situations. Ramp storage is not utilized, and/or secondary queue may be a big concern here.	↓ MeterRateHigh	Redistributes the metering rate fuzzy classes to decrease the metering rate. ↓ MeterRate
	↓ MeterRateLow	Redistributes the metering rate fuzzy classes to decrease the metering rate. ↓ MeterRate
High metering rate must be higher. Queue storage is problematic, but don't necessarily want to affect small metering rates because of difficult local merge.	↑ MeterRateHigh	Redistributes the metering rate fuzzy classes to increase the metering rate. Affects the VB and B classes the most. Has little effect on S and VS metering classes. ↑ MeterRate
High metering rate must be lower. Ramp storage is not utilized.	↓ MeterRateHigh	Redistributes the metering rate fuzzy classes to decrease the metering rate. Affects the VB and B classes the most. Has little effect on S and VS metering classes. ↓ MeterRate

<b>Meter Rate Problems</b>	<b>Parameter Change</b>	<b>Effect</b>
Low metering rate must be higher. Queue storage is a problem.	↑ MeterRateLow	Redistributes the metering rate fuzzy classes to increase the metering rate. Affects the VS and S classes the most. Has little affect on the B and VB classes. ↑ MeterRate
Low metering rate must be lower. Secondary queue may be problematic.	↓ MeterRateLow	Redistributes the metering rate fuzzy classes to decrease the metering rate. Affects the VS and S classes the most. Has little affect on the B and VB classes. ↓ MeterRate

<b>Secondary Queue Problems</b>	<b>Parameter Change</b>	<b>Effect</b>
Secondary queue formation is problematic and takes precedent over queue length.	↑ LocalOccVbWt	Increases response to highly congested merge. ↓ MeterRate
	↑ LocSpVs_OccVbWt	Increases response to highly congested merge. ↓ MeterRate
	↓ MeterRateLow	Redistributes the metering rate fuzzy classes to decrease the metering rate. Affects the VS and S classes the most. Has little affect on the B and VB classes. ↓ MeterRate

wide default speed classes are sensitive to small perturbations in speed (shown in Figure 2). It does not matter if the data are inaccurate, as long as the data map to the correct class.

### **Compensating for Poor Detector Placement**

For control purposes, queue and advance queue detectors are poorly placed on many ramps. There are two common situations in which the advance queue occupancy is not indicative of the long wait time in the queue:

1) Advance queue detectors that are located at the entrance to a ramp where a signal is located tend to read very low unless a vehicle is blocking the arterial. A surprising number of drivers are willing to take this risk on the left hand turn movement, but the frequency of occurrence is not consistent. This blocking only takes place immediately after the left hand turn movement. For the remainder of the cycle, the advance queue occupancy reads very low (less than 8 percent) and does not reflect the long queues that continue on the arterial. In this case, the advance queue detector is located at the only consistent gap in the queue.

2) Advance queue detectors that are located far beyond the location where we would like the queue to extend are of limited usefulness. We can compensate for poor advance queue detector placement by reacting more strongly to the queue detector. However, over-reacting to the queue detector may result in a queue that ends before the queue detector, which tends to under-utilize our ramp storage between the queue and advance queue detectors. For many long, high-volume ramps, the region of the ramp where we most need detection is nebulous. With a high queue occupancy and a very low advance queue occupancy, we may have anywhere from five to forty vehicles in the queue (such as Swamp Creek to SB I-5 or 205th on SB I-5).

Although the ramp metering algorithms' control of the queue is limited by detector location to some extent, tuning the fuzzy logic ramp metering algorithm can compensate for poor detector placement. The ramp at 164<sup>th</sup> Street to SB I-5 is an example of situation 1),



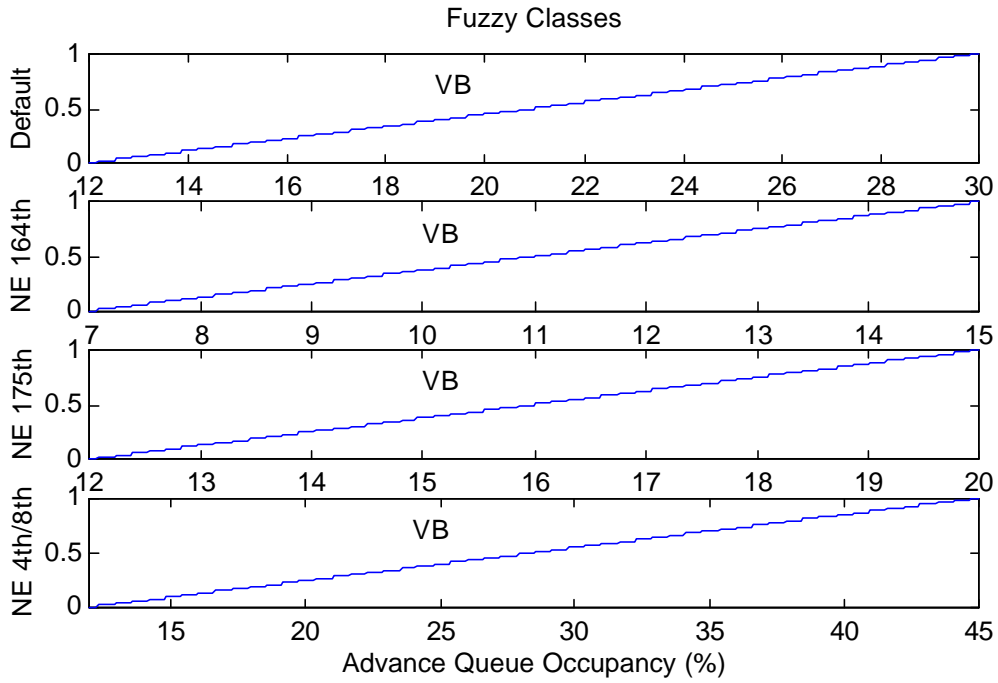
in which the advance queue detector data are too oscillatory and too low. For this situation, the number of samples used to calculate this input was increased from two to three. (For this change in the fuzzy equation to take effect, the RMDB had to be rebuilt). With 1-minute data, the occupancy was smoothed over a longer time frame. The data more consistently reflected the queue. However, the high occupancy readings of the left hand turn movement averaged with the low occupancy readings of the gap in the queue resulted in a lower occupancy than the peaks of the 20-second sample. For this reason, we redefined the fuzzy classes to increase our sensitivity to this input. The **AdvQueueOccLow** was reduced from 12 to 7, and the **AdvQueueOccHigh** was reduced from 30 to 15. Figure 28 shows the fuzzy class before the change and after the change. The advance queue response began sooner at 7 percent occupancy rather than 12 percent occupancy. Maximum response was reached sooner at 15 percent occupancy rather than 30 percent occupancy. This change affected timing of the response but not the maximum strength of the response.

In situation 2), the queue would be excessive if it reached the advance queue detector, and we want to prevent this rather than react to it. Redefining the fuzzy class over a lower dynamic range means that the controller responds to a less dense queue formation, which correlates to a shorter queue. An example of this is NE 175<sup>th</sup> Street to SB I5, where the advance queue detector is located on a devoted right hand turn lane of the arterial. Because the wait time is often too long even before the advance queue occupancy reads high, we wanted to increase our sensitivity to this input. The **AdvQueueOccHigh** was reduced from 30 percent to 20 percent to reach full activation sooner. The resulting fuzzy class is shown in Figure 28.

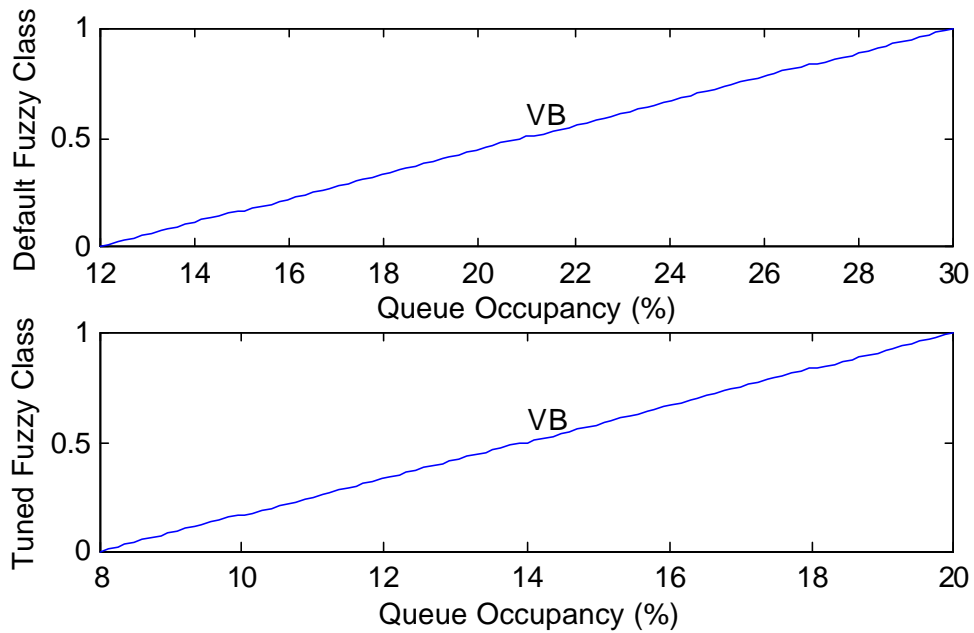
Likewise, if the queue loop is located too close to the arterial, we can adjust its fuzzy class for greater sensitivity. For NE 128<sup>th</sup> Street, the ramp storage between the queue detector and arterial was inadequate when the signal dumped a huge platoon. To provide a more preventative queue response, we reduced the **QueueOccLow** to 8 and

**QueueOccHigh** to 20. In this manner, a less dense, shorter queue would activate a queue response.

Much more prevalent is the problem in which the queue detector is located too close to the stop bar. In this situation, overreacting to the queue input results in under-utilizing the ramp storage. We could increase the **QueueOccLow** and **QueueOccHigh** to respond to more dense queue formation. However, tuning the fuzzy class is only somewhat effective for this particular input because the queue most always extends beyond the detector, and thus, queue occupancy is very high most all of the time. Because the somewhat binary nature of queue occupancy data, it makes little difference if the **QueueOccHigh** is 30 percent or 50 percent when the queue occupancy almost always reads over 70 percent. NE 4<sup>th</sup>/8<sup>th</sup> Street to SB I-405 is an example of this problem. For this ramp, the **QueueOccWt** is only 1 to encourage the queue to form beyond the queue detector. Preventing an excessive ramp queue is done almost entirely through the advance queue detectors for this ramp because their proximity is much closer to the location where we want the queue to end.



**Figure 28. Default and Tuned Fuzzy Classes of Advance Queue Occupancy**



**Figure 29. Default and Tuned Fuzzy Classes of Queue Occupancy**

While it is common for the queue detectors to be too close to the stop bar, it is unusual for the advance queue detectors to be too close to the stop bar. Typically, the advance queue detectors are located at the very end of the available storage. However, for NE 4<sup>th</sup>/8<sup>th</sup> Street to SB I-405, both the queue and advance queue detectors are closer to the stop bar than we would like. To allow the queue to build a bit beyond the advance queue detectors, we have increased the **AdvQueueOccHigh** from 30 percent to 45 percent. (See Figure 28.) This technique works better for advance queue detectors than for queue detectors because there is more variance in density further back in the queue. At the same time, we need a very strong advance queue response before the queue reaches the dangerous situation of exiting vehicles weaving with metered vehicles. While the adjusted fuzzy class allows the queue to build a bit beyond the advance detectors, it does not reach back to the hazardous exit weave because, by then, the degree of activation is full, and the response is strong with a high **AdvQueueOccWt** of 8.

The point to stress here is that the fuzzy classes for any *input* should only need adjustment when that data do not accurately reflect conditions, either because of poor detector calibration or poor detector placement. That is when the definition of big, small, etc., needs to be modified from its system defaults. If the problem is a matter of queue length rather than queue detection, this tuning should be done through the rule weights, which reflect the control objectives.

### **Tuning the Ramp Queue**

The most common ramp tuning problem is an excessive ramp queue. The **AdvQueueOccWt** and **QueueOccWt** balance the queue objective with the mainline objectives. Increasing these rule weights emphasizes a constraint that the ramp queue may not be excessive. Within that constraint, the lower priority control objectives have influence.

How do we know whether to increase the **QueueOccWt** or **AdvQueueOccWt**? In general, queue control is very sensitive to detector placement. It depends on detector location relative to where we want the queue to end. Often the advance queue detector is so far back from the stop bar that the wait time is unreasonable if the queue reaches it, such as Swamp Creek to I-5 SB. In this case, we rely on the queue detector for primary control, with a **QueueOccWt1** of 6.0 and a **QueueOccWt2** of 4.0 (metered independently). At 5.0, the **AdvQueueOccWt1** and **AdvQueueOccWt2** are high as well, in the event the queue does get out of hand.

If we want to utilize the storage between the queue and advance queue detectors, but we cannot allow the queue to block the arterial, a default queue weight but strong advance queue weighting is appropriate. Northgate to I-5 NB is a representative example of this problem. Here the **AdvQueueOccWt** was increased from 4 to 6. This is a common situation because the advance queue detector is typically located at the tail end of the available storage.

Shorter, high demand ramps with inadequate storage require a more preventative response through the increase of **QueueOccWt**, in addition to a strong advance queue response. For example, 164<sup>th</sup> Street SW to SB I-5 has extremely high volumes (21 VPM) relative to the available storage. Until the new lane is added to double the storage (project is underway), the **QueueOccWt** is 5 and the **AdvQueueOccWt** is 6.

Conversely, if ramp storage is underutilized, particularly when the merge is problematic, the **QueueOccWt** or **AdvQueueOccWt** should be reduced. If excessive ramp queue formation never seems to be a concern at this ramp, or if secondary queue formation is a higher priority than the queue size, the **AdvQueueOccWt** may be reduced. More likely, we want to utilize more of the ramp storage up to a point, but excessive queue formation is still a concern. In this case, reducing the **QueueOccWt** is a better choice. For NE 224<sup>th</sup>/236<sup>th</sup> to SB I-5, secondary queue formation is a particular concern, while ramp storage was somewhat underutilized. Here the **QueueOccWt** was reduced to 1.5,

and the **AdvQueueOccWt** was reduced to 3.0. If in doubt which weight to adjust, use the queue rule when you have play in the system, and the advance queue rule when you want to issue an ultimatum.

It is a good idea to check how much a change affects the worst case scenario, and there are two immediate and easy ways to do this. During heavy congestion, all occupancies are VB and all speeds are VS to a degree of 1. For peak periods, the degree of activation remains the same, but tuning the rule weight changes the metering rate. Gauge the effect of a rule weight change through *watch\_fuzzymeter*. (See Figure 6.) One method is to look at the metering rate classes. This shows the sum of the rule outcomes for each class multiplied by their rule weights. When you see the rule weight update on *watch\_fuzzymeter*, the activation of the corresponding metering class will change too. Notice how much this moves the new centroid of the metering rate, shown to the left of the metering classes (provided that the change was not due to the HOV adjustment). If this centroid moved while all degrees of rule activation remained the same, this is the effect of the new rule weighting during that traffic pattern. A second method can be used if two adjacent metered lanes have identical controller inputs. Make the change to one lane's rule weight but not the other. Observe the difference in metering rates for various traffic patterns, and choose the one that is more effective. After the test, set both lanes to the same weightings so they will meter at the same rate.

Even if the worst case scenario does not occur, you can estimate what the controller would do in this case. Assuming full activation during the worst case scenario, add up all rule weights contributing to the VS class and all rule weights contributing to the VB class. Knowing your **MeterRateHigh** and **MeterRateLow**, estimate where the centroid would be.

## Tuning the Metering Rate

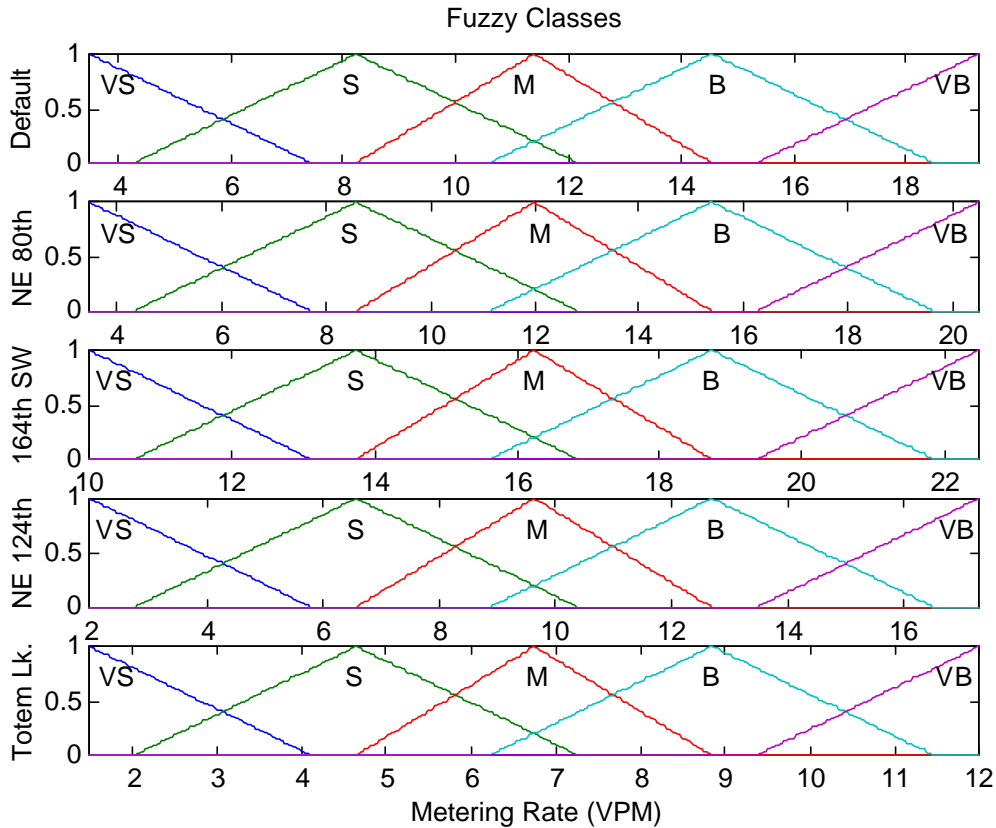
The **MeterRateLow** and **MeterRateHigh** are very powerful parameters that define “small metering rate”, “medium metering rate,” and so on. These should be tuned when the relative weighting of the rules is correct but the resulting metering rate outcome is not. Because the metering classes are uniformly distributed between the **MeterRateLow** and **MeterRateHigh**, altering the **MeterRateLow** parameter primarily affects the VS and S metering class, with less effect on the M, and little effect on the B and VB classes. Conversely, altering the **MeterRateHigh** parameter primarily affects the upper classes and has diminishing effect on lower classes.

With that in mind, examine NE 80<sup>th</sup> to NB I-5. This ramp has two conflicting problems: the local merge is very congested, and the queue is too long relative to the available storage. When secondary queue formation dominates the objectives, we want a low metering rate. But when the merge is okay, we want a high metering rate. By increasing the **MeterRateHigh** from 19.3 to 20.5, we increase the upper range of metering rates without affecting the lower ones. See how the centroid of the upper classes shift in Figure 30. The controller meters higher when a secondary queue is not a problem, yet it still meters low when necessary to prevent a secondary queue.

**MeterRateLow** and **MeterRateHigh**. This is a solution for ramps that have a major storage problem but not a merge problem, such as 164<sup>th</sup> SW Street to SB I-5. Figure 30 shows the fuzzy classes where the **MeterRateLow** is 10.0, and the **MeterRateHigh** is 22.5. Even with activation of only the VS class, the controller cannot meter lower than 10.0.

If we want the ramp to meter higher in general, we should increase both the For ramps with secondary queue problems, the **MeterRateLow** can be reduced. For NE 124<sup>th</sup> Street to SB I-405, **MeterRateLow** was reduced to 2.0. This way, the metering rate would be lower when secondary queue prevention was the primary objective, while the

upper metering classes were unchanged to provide adequate queue response the rest of the time (Figure 30).



**Figure 30. Default and Tuned Fuzzy Classes of Meter Rate**

For ramps where the secondary queue is an issue, but queue length is not a problem, reduce both the **MeterRateLow** and **MeterRateHigh**. For Totem Lake to NB I-405, the ramp was low volume, but the merge was very difficult. The **MeterRateLow** was reduced to 1.5, and the **MeterRateHigh** was reduced to 12.0 to meter more restrictively in general. Figure 30 shows the resulting fuzzy classes, which prevent secondary queue formation and utilize the ramp storage better.

It is easy to gauge how much changing the **MeterRateLow** and **MeterRateHigh** will affect the metering rate for a given traffic pattern by using *watch\_fuzzymeter*. (See



Algorithm Observation.) If the rule outcomes, rule weightings, and HOV adjustment are constant, a change in metering rate is the result of the redefined metering rate classes.

The minimum and maximum metering rates are not to be confused with the dynamic range limits. The **MaxMeterRate** and **MinMeterRate** limit the possible metering rates for a given cabinet. They bound the metering rates produced by the fuzzy logic ramp metering algorithm, as well as all other metering algorithms. *Watch\_fuzzymeter* shows the algorithm's metering rates, and TMS shows the implemented rates after being bounded by the cabinet's minimum and maximum rates. (There is a two sample delay between when the rate is calculated, when it is sent to the 170, and when the 170 returns the rate that was implemented.) These are independent parameter types that have different effects. If you increase the **MeterRateHigh** above the **MaxMeterRate**, the controller will meter higher more often, even though it still will not meter above the **MaxMeterRate**. Likewise, it is no problem (and actually common) to have the **MeterRateLow** less than the **MinMeterRate** to meter lower in general without affecting the minimum rate. However, if you decrease the **MeterRateHigh** below the **MaxMeterRate**, note that the meter rate will not achieve the **MaxMeterRate**. Similarly, if the **MeterRateLow** is increased above the **MinMeterRate**, the minimum metering rate cannot be reached. In short, if you decide to decrease the dynamic range of the metering rate classes, you should also decrease the range of the min/max rate for clarity. If you increase the dynamic range of the metering classes, you may or may not increase the range of the min/max rate, depending on the intended effect.

Also keep in mind that the centroid of a right triangle is  $1/3$  of the base. In other words, the highest metering rate that can be achieved when only the VB class is in effect is less than the **MeterRateHigh** by  $1/3$  of the base for that class. This is why the default **MeterRateHigh** is greater than the default maximum metering rate. For ramps that have one lane, the maximum metering rate is 18.0 VPM, and the **MeterRateHigh** is 19.3 to reach that maximum. For ramps where more than one lane merges together before entering the

mainline, the maximum metering rate is 16.0 VPM, and the MeterRateHigh is 17.3 in order to reach that maximum. The minimum metering rate is 7.0 for a single lane and 5.0 for multiple lanes, with respective MeterRateLows of 3.5 and 3.0. Although the VS class alone would have a centroid of less than the minimum, a traffic pattern that would activate only the VS class is rare. Thus, the low dynamic range has the effect of shifting the VS, S, and M metering rates down to or near the minimum more frequently.

### **Preventing a Secondary Queue**

For some ramps, reducing the MeterRateLow is not sufficient to prevent secondary queue formation. Modifying the rule weights can help when the secondary queue formation creates a mainline bottleneck and the queue length is of little concern (either because the ramp storage is underutilized such as on SR 516 to SB SR-167, or because the queue is hopeless, such as on Montlake to EB 520). For SR 516, the MeterRateLow is 1.0. In addition to this change, the LocalOccVbWt was increased to 4.5, and the LocSpVs\_OccVbWt was increased to 3.0. When the mainline merge is highly congested, the objective to prevent a secondary queue dominates over the queue length. In fact, the storage at this ramp was underutilized until we decreased the QueueOccWt to 0. The queue control is done strictly with the advance queue rule of weight 4.0. These rule weights are balanced to prevent a secondary queue and utilize the full ramp storage without exceeding it.

## SUMMARY

For the long-term success of TMS software, the practical aspects of implementation, operation, and maintenance are as important as the ramp metering behavior. Over time, traffic management software needs the ability to expand to include more ramps with higher demand. With changing traffic patterns, ramp metering may need adjustment. Depending on local politics and geometry, the priorities of objectives may vary from one location to the next. Thus, the ability to tune the behavior of the ramp metering algorithm is a key feature. The design of the fuzzy logic ramp metering algorithm uses a format similar to human reasoning, allowing the operator to easily achieve the desired balance between control objectives.

With all of the tuning examples illustrated in this manual, the reader may have the impression that the fuzzy logic ramp metering algorithm requires significant tuning for location variations. That is not the case. The intent of this user guide is to demonstrate the range of the algorithm's capability. Of the 126 ramp meters that use this algorithm, most of these perform best with the system-wide defaults. The algorithm is flexible to handle special cases, such as poor detection, inadequate ramp storage, and secondary queues. While tuning is typically done during the peak period, the key to optimization is to tune the parameter that has the intended effect throughout all traffic patterns, not just the one during which tuning took place.

When properly tuned, the fuzzy logic ramp metering algorithm can expertly handle incidents, special events, poor data, and unusual weather, without any need to modify the control parameters. Because these situations occur more often than not in Seattle, it is vital that the ramp metering algorithm perform well under a wide range of conditions. If the operator finds that the ramp metering algorithm is not performing well under this spectrum of conditions, that is a sign that the ramp metering algorithm is not optimally tuned.

## **ACKNOWLEDGMENTS**

A project of this scale required a coordinated group effort. We are grateful to Paul Neel and Brian Dobbins for their invigorating optimism and enthusiasm for this algorithm, which gradually percolated throughout WSDOT. Paul and Brian's in-depth knowledge of the ramp metering issues at each implementation site provided valuable insight for the algorithm design. Paul put forth a tremendous effort in integration, fine-tuning, and evaluation. Paul Neel and Jan Pazhouh motivated the FLOW operators to assist with our project in any way possible. The operators were a pleasure to work with, with their quick-learning, intimate knowledge of the system and excitement for the improvements produced by the algorithm. The operators were involved in all aspects of integration, tuning, evaluation, and editing: Matt Beaulieu, Mike Boonsripisal, Carolyn Cheung, Daryl Coffland, Eric French, Jason Gibbens, Kristin Green, Drew Kanikeberg, Wayne King, Kevin Mizuta, Mike Nichols, Jill Seager, and Christine Taylor.

## REFERENCES

- Chen and A. May, 1990. "Freeway Ramp Control Using Fuzzy Set Theory for Inexact Reasoning," *Transportation Research-A*, Vol. 24A, No. 1, pp. 15-25.
- J. Ishimaru and M. Hallenbeck, 1999. "Flow Evaluation Design," Technical Report, WA-RD 466.2.
- L. Jacobson, K. Henry, and O. Mehyar, 1988. "Real-Time Metering Algorithm for Centralized Control," *Transportation Research Record* 1232, National Research Council, Washington, D.C., pp. 17.26.
- B. Kosko, 1993. Fuzzy Thinking: The New Science of Fuzzy Logic, Hyperion, New York.
- Masher, Ross, Wong, Tuan, Zeidler, and Petracek, 1975. *Guidelines for Design and Operation of Ramp Control Systems*, Stanford Research Institute, Menlo Park, CA, p. II\_18-II\_24.
- H. Taale, J. Slager, and J. Rosloot, 1996. "The Assessment of Ramp Metering Based on Fuzzy Logic," Proceedings of the Third Annual World Congress on Intelligent Transport Systems, Orlando, Florida.
- C. Taylor and D. Meldrum, 2000. "Evaluation of a Fuzzy Logic Ramp Metering Algorithm: A Comparative Study Between Three Ramp Metering Algorithms used in the Greater Seattle Area," WA-RD Technical Report to be published, Washington State Department of Transportation, National Technical Information Service.
- C. Taylor and D. Meldrum, 2000. "A Programmer's Guide to the Fuzzy Logic Ramp Metering Algorithm: Software Design, Integration, Testing, and Evaluation," WA-RD Technical Report to be published, Washington State Department of Transportation, National Technical Information Service.
- C. Taylor and D. Meldrum, 1995. "Simulation Testing of a Fuzzy Neural Ramp Metering Algorithm," Final Technical Report. Washington State Department of Transportation, National Technical Information Service, WA-RD 395.1.
- S. Yasunobu and S. Miyamoto, 1985. "Automatic Train Operation by Predictive Fuzzy Control," *Industrial Applications of Fuzzy Control*, editor M. Sugeno, pp. 1-18, North-Holland, Amsterdam.
- L. Zadeh, 1965. "Fuzzy Sets," *Information and Control* 8, pp. 338-353.

## APPENDIX: Complete List of Fuzzy Meter Equations

ES-061R:MMS\_FM1 = ES-059D:\_MS\_Stn | ES-057D:\_MS\_Stn &  
ES-055D:\_MS\_Stn | ES-068D:\_MS\_Stn | ES-061R:\_MS\_I\_1(1) &  
ES-061R:\_MS\_I\_2(1) | ES-061R:\_MSRA\_1(1) & ES-061R:\_MSRA\_2(1) |  
ES-061R:\_MSHP\_2(35)

ES-061R:MMS\_FM2 = ES-059D:\_MS\_Stn | ES-057D:\_MS\_Stn &  
ES-055D:\_MS\_Stn | ES-068D:\_MS\_Stn | ES-061R:\_MS\_I\_1(1) &  
ES-061R:\_MS\_I\_2(1) | ES-061R:\_MSRA\_1(1) & ES-061R:\_MSRA\_2(1) |  
ES-061R:\_MSHP\_2(35)

ES-067R:MMN\_FM1 = ES-067R:MMN\_Stn | ES-070R:\_MN\_Stn &  
ES-079D:\_MN\_Stn & ES-083D:\_MN\_Stn & ES-088D:\_MN\_Stn &  
ES-090D:\_MN\_Stn | ES-059D:\_MN\_Stn | ES-067R:\_MN\_Q\_1(1) &  
ES-067R:\_MN\_Q\_2(1) | ES-067R:\_MNRA\_1(1) & ES-067R:\_MNRA\_2(1) |  
ES-067R:\_MNHP\_2(30)

ES-067R:MMN\_FM2 = ES-067R:MMN\_Stn | ES-070R:\_MN\_Stn &  
ES-079D:\_MN\_Stn & ES-083D:\_MN\_Stn & ES-088D:\_MN\_Stn &  
ES-090D:\_MN\_Stn | ES-059D:\_MN\_Stn | ES-067R:\_MN\_Q\_1(1) &  
ES-067R:\_MN\_Q\_2(1) | ES-067R:\_MNRA\_1(1) & ES-067R:\_MNRA\_2(1) |  
ES-067R:\_MNHP\_2(30)

ES-070R:MMS\_FM1 = ES-070R:MMS\_Stn | ES-057D:\_MS\_Stn &  
ES-055D:\_MS\_Stn | ES-074D:\_MS\_Stn | ES-070R:\_MS\_I\_1(2) |  
ES-070R:\_MSRA\_1(2) | ES-070R:\_MSHP\_1(50)

ES-071R:MMS\_FM1 = ES-071R:MMS\_Stn | ES-070R:MMS\_Stn &  
ES-057D:\_MS\_Stn | ES-074D:\_MS\_Stn | ES-071R:\_MS\_Q\_1(1) &  
ES-071R:\_MS\_Q\_2(1) | ES-071R:\_MSRA\_1(1) & ES-071R:\_MSRA\_2(1)

ES-073R:MMN\_FM1 = ES-073R:MMN\_Stn | ES-079D:\_MN\_Stn &  
 ES-083D:\_MN\_Stn & ES-088D:\_MN\_Stn & ES-093D:\_MN\_Stn &  
 ES-104D:\_MN\_Stn | ES-069D:\_MN\_Stn | ES-073R:\_MN\_Q\_1(1) |  
 ES-073R:\_MNRA\_1(2) | ES-073R:\_MNHP\_1(50)

ES-075R:MMS\_FM1 = ES-075R:MMS\_Stn | ES-070R:MMS\_Stn &  
 ES-057D:\_MS\_Stn | ES-079D:\_MS\_Stn | ES-075R:\_MS\_Q\_1(2) |  
 ES-075R:\_MSRA\_1(2) | ES-075R:\_MSHP\_1(50)

ES-077R:MMN\_FM1 = ES-079D:\_MN\_Stn | ES-083D:\_MN\_Stn &  
 ES-088D:\_MN\_Stn & ES-093D:\_MN\_Stn & ES-104D:\_MN\_Stn |  
 ES-076R:MMN\_Stn | ES-077R:\_MN\_Q\_1(2) | ES-077R:\_MNRA\_1(2) |  
 ES-077R:\_MNHP\_1(25)

ES-077R:MMN\_FM2 = ES-079D:\_MN\_Stn | ES-083D:\_MN\_Stn &  
 ES-088D:\_MN\_Stn & ES-093D:\_MN\_Stn & ES-104D:\_MN\_Stn |  
 ES-076R:MMN\_Stn | ES-077R:\_MN\_Q\_2(2) | ES-077R:\_MNRA\_2(2) |  
 ES-077R:\_MNHP\_1(25)

ES-085R:MMS\_FM1 = ES-085R:MMS\_Stn | ES-080D:\_MS\_Stn &  
 ES-070R:MMS\_Stn & ES-059D:\_MS\_Stn | ES-088D:\_MS\_Stn |  
 ES-085R:\_MS\_I\_1(1) & ES-085R:\_MS\_I\_2(1) | ES-085R:\_MSRA\_1(1) &  
 ES-085R:\_MSRA\_2(1) | ES-085R:\_MSHP\_2(50)

ES-085R:MMS\_FM2 = ES-085R:MMS\_Stn | ES-080D:\_MS\_Stn &  
 ES-070R:MMS\_Stn & ES-059D:\_MS\_Stn | ES-088D:\_MS\_Stn |  
 ES-085R:\_MS\_I\_1(1) & ES-085R:\_MS\_I\_2(1) | ES-085R:\_MSRA\_1(1) &  
 ES-085R:\_MSRA\_2(1) | ES-085R:\_MSHP\_2(50)

ES-086R:MMN\_FM1 = ES-087R:MMN\_Stn | ES-088D:\_MN\_Stn &  
 ES-093D:\_MN\_Stn & ES-094R:MMN\_Stn & ES-104D:\_MN\_Stn |  
 ES-083D:\_MN\_Stn | ES-086R:\_MN\_Q\_1(1) | ES-086R:\_MNRA\_1(2) |  
 ES-086R:\_MNHP\_1(50)

ES-087R:MMN\_FM1 = ES-087R:MMN\_Stn | ES-088D:\_MN\_Stn &  
 ES-093D:\_MN\_Stn & ES-094R:MMN\_Stn & ES-104D:\_MN\_Stn |  
 ES-086R:MMN\_Stn | ES-087R:\_MN\_I\_1(2) | ES-087R:\_MNRA\_1(2) |  
 ES-087R:\_MNHP\_2(25)

ES-087R:MMN\_FM2 = ES-087R:MMN\_Stn | ES-088D:\_MN\_Stn &  
 ES-093D:\_MN\_Stn & ES-094R:MMN\_Stn & ES-104D:\_MN\_Stn |  
 ES-086R:MMN\_Stn | ES-087R:\_MN\_I\_1(2) | ES-087R:\_MNRA\_1(2) |  
 ES-087R:\_MNHP\_2(25)

ES-092R:MMS\_FM1 = ES-092R:MMS\_Stn | ES-090D:\_MS\_Stn &  
 ES-080D:\_MS\_Stn & ES-070R:MMS\_Stn & ES-059D:\_MS\_Stn |  
 ES-093D:\_MS\_Stn | ES-092R:\_MS\_I\_1(2) | ES-092R:\_MSRA\_1(2)

ES-094R:MMN\_FM1 = ES-094R:MMN\_Stn | ES-098D:\_MN\_Stn &  
 ES-104D:\_MN\_Stn | ES-093D:\_MN\_Stn | ES-094R:\_MN\_Q\_1(1) |  
 ES-094R:\_MNRA\_1(1) | ES-094R:\_MNHP\_1(50)

ES-100R:MMS\_FM1 = ES-100R:MCS\_\_\_1 |  
 ES-101R:MMS\_Stn & ES-093D:\_MS\_Stn & ES-085R:MMS\_Stn &  
 ES-070R:MMS\_Stn & ES-059D:\_MS\_Stn |  
 ES-102R:\_MS\_Stn | ES-100R:\_MS\_Q\_1(2) | ES-100R:\_MSRA\_1(2)

ES-102R:MMN\_FM1 = ES-104D:\_CN\_Stn | ES-108D:\_MN\_Stn &  
 ES-111R:MMN\_Stn & ES-123D:\_MN\_Stn & ES-125R:\_MN\_Stn |  
 ES-098D:\_MN\_Stn | ES-102R:\_CN\_Q\_1(2) | ES-102R:\_CNRA\_1(2)

ES-102R:MMN\_FM2 = ES-104D:\_CN\_Stn | ES-108D:\_MN\_Stn &  
 ES-111R:MMN\_Stn & ES-123D:\_MN\_Stn & ES-125R:\_MN\_Stn |  
 ES-098D:\_MN\_Stn | ES-102R:\_CN\_Q\_2(2) | ES-102R:\_CNRA\_2(2)

ES-111R:MMN\_FM1 = ES-111R:MMN\_Stn | ES-123D:\_MN\_Stn &  
 ES-125R:\_MN\_Stn | ES-108D:\_MN\_Stn | ES-111R:\_MN\_Q\_1(1) &  
 ES-111R:\_MN\_Q\_2(1) | ES-111R:\_MNRA\_1(1) & ES-111R:\_MNRA\_2(1)



ES-111R:MMN\_FM2 = ES-111R:MMN\_Stn | ES-123D:\_MN\_Stn &  
     ES-125R:\_MN\_Stn | ES-108D:\_MN\_Stn | ES-111R:\_MN\_Q\_1(1) &  
     ES-111R:\_MN\_Q\_2(1) | ES-111R:\_MNRA\_1(1) & ES-111R:\_MNRA\_2(1)

ES-125R:MMS\_FM1 = ES-125R:MMS\_Stn | ES-105D:\_MS\_Stn &  
     ES-118R:\_MS\_Stn | ES-126D:\_MS\_Stn | ES-125R:\_MS\_Q\_1(1) |  
     ES-125R:\_MSRA\_1(1)

ES-134R:MMS\_FM1 = ES-134R:MMS\_Stn | ES-105D:\_MS\_Stn &  
     ES-118R:\_MS\_Stn & ES-128D:\_MS\_Stn & ES-130D:\_MS\_Stn |  
     ES-136R:MMS\_Stn | ES-134R:\_MS\_Q\_1(3) | ES-134R:\_MS\_Q\_1(6) |  
     ES-134R:\_MSHP\_1(60)

ES-136R:MMS\_FM1 = ES-136R:MMS\_Stn | ES-105D:\_MS\_Stn &  
     ES-118R:\_MS\_Stn & ES-128D:\_MS\_Stn & ES-130D:\_MS\_Stn &  
     ES-134R:MMS\_Stn | ES-141R:MMS\_Stn | ES-136R:\_MS\_Q\_1(1) |  
     ES-136R:\_MS\_Q\_1(3)

ES-137R:MMN\_FM1 = ES-137R:MMN\_Stn | ES-151R:MMN\_Stn &  
     ES-163R:\_MN\_Stn & ES-170D:\_MN\_Stn & ES-175R:MMN\_Stn &  
     ES-184R:MMN\_Stn | ES-132D:\_MN\_Stn | ES-137R:\_MN\_Q\_1(1) |  
     ES-137R:\_MN\_Q\_1(3) | ES-137R:\_MNHP\_1(60)

ES-139R:MMN\_FM1 = ES-139R:MMN\_Stn | ES-151R:MMN\_Stn &  
     ES-163R:\_MN\_Stn & ES-170D:\_MN\_Stn & ES-175R:MMN\_Stn &  
     ES-184R:MMN\_Stn | ES-137R:MMN\_Stn | ES-139R:\_MN\_Q\_1(2) |  
     ES-139R:\_MNRA\_1(2) | ES-139R:\_MNHP\_1(60)

ES-141R:MMS\_FM1 = ES-141R:MMS\_Stn | ES-105D:\_MS\_Stn &  
     ES-118R:\_MS\_Stn & ES-128D:\_MS\_Stn & ES-130D:\_MS\_Stn &  
     ES-136R:MMS\_Stn | ES-143D:\_MS\_Stn | ES-141R:\_MS\_Q\_1(1) |  
     ES-141R:\_MSRA\_1(1)

ES-146R:MMN\_FM1 = ES-146R:MMN\_Stn | ES-151R:MMN\_Stn &  
ES-163R:\_MN\_Stn & ES-170D:\_MN\_Stn & ES-175R:MMN\_Stn &  
ES-184R:MMN\_Stn | ES-143D:\_MN\_Stn | ES-146R:\_MN\_Q\_1(1) |  
ES-146R:\_MN\_Q\_1(3)

ES-149R:MMS\_FM1 = ES-149R:MMS\_Stn | ES-118R:\_MS\_Stn &  
ES-128D:\_MS\_Stn & ES-130D:\_MS\_Stn & ES-136R:MMS\_Stn &  
ES-141R:MMS\_Stn & ES-143D:\_MS\_Stn & ES-145D:\_MS\_Stn |  
ES-152D:\_MS\_Stn | ES-149R:\_MS\_Q\_1(1) | ES-149R:\_MSRA\_1(1) |  
ES-149R:\_MSHP\_1(50)

ES-151R:MMN\_FM1 = ES-151R:MMN\_Stn | ES-163R:\_MN\_Stn &  
ES-170D:\_MN\_Stn & ES-175R:MMN\_Stn & ES-184R:MMN\_Stn |  
ES-148D:\_MN\_Stn | ES-151R:\_MN\_Q\_1(2) | ES-151R:\_MNRA\_1(2) |  
ES-151R:\_MNHP\_1(60)

ES-156R:MMS\_FM1 = ES-156R:MMS\_Stn | ES-118R:\_MS\_Stn &  
ES-128D:\_MS\_Stn & ES-130D:\_MS\_Stn & ES-136R:MMS\_Stn &  
ES-141R:MMS\_Stn & ES-143D:\_MS\_Stn & ES-145D:\_MS\_Stn &  
ES-149R:MMS\_Stn | ES-161D:\_MS\_Stn | ES-156R:\_CS\_Q\_1(1) &  
ES-156R:\_CS\_I\_1(1) | ES-156R:\_CS\_Q\_1(1) & ES-156R:\_CS\_I\_1(1) |  
ES-156R:\_CSHP\_1(50)

ES-158R:MMS\_FM1 = ES-156R:MMS\_Stn | ES-118R:\_MS\_Stn &  
ES-128D:\_MS\_Stn & ES-130D:\_MS\_Stn & ES-136R:MMS\_Stn &  
ES-141R:MMS\_Stn & ES-143D:\_MS\_Stn & ES-145D:\_MS\_Stn &  
ES-149R:MMS\_Stn | ES-161D:\_MS\_Stn | ES-158R:\_CS\_Q\_1(1) |  
ES-158R:\_CS\_Q\_1(3)

ES-159R:MMN\_FM1 = ES-159R:MMN\_Stn | ES-163R:\_MN\_Stn &  
 ES-170D:\_MN\_Stn & ES-175R:MMN\_Stn & ES-184R:MMN\_Stn |  
 ES-156R:\_MN\_Stn | ES-159R:\_MN\_Q\_1(2) | ES-159R:\_MNRA\_1(2) |  
 ES-159R:\_MNHP\_2(35)

ES-159R:MMN\_FM2 = ES-159R:MMN\_Stn | ES-163R:\_MN\_Stn &  
 ES-170D:\_MN\_Stn & ES-175R:MMN\_Stn & ES-184R:MMN\_Stn |  
 ES-156R:\_MN\_Stn | ES-159R:\_MN\_Q\_2(2) | ES-159R:\_MNRA\_2(2) |  
 ES-159R:\_MNHP\_2(25)

ES-163R:MMS\_FM1 = ES-163R:MMS\_Stn | ES-136R:MMS\_Stn &  
 ES-143D:\_MS\_Stn & ES-158R:MMS\_Stn | ES-165D:\_MS\_Stn |  
 ES-163R:\_MS\_I\_1(1) | ES-163R:\_MSRA\_1(1) | ES-163R:\_MSHP\_1(50)

ES-168R:MMN\_FM1 = ES-168R:MMN\_Stn | ES-170D:\_MN\_Stn &  
 ES-175R:MMN\_Stn & ES-184R:MMN\_Stn & ES-205D:\_MN\_Stn &  
 ES-212D:\_MN\_Stn & ES-216D:\_MN\_Stn & ES-222D:\_MN\_Stn |  
 ES-165D:\_MN\_Stn | ES-168R:\_MN\_Q\_1(2) | ES-168R:\_MNRA\_1(2) |  
 ES-168R:\_MNHP\_1(60)

ES-174R:MMS\_FM1 = ES-174R:MMS\_Stn | ES-165D:\_MS\_Stn &  
 ES-170D:\_MS\_Stn | ES-177D:\_MS\_Stn | ES-174R:\_MS\_Q\_1(2) |  
 ES-174R:\_MSRA\_1(1) | ES-174R:\_MSHP\_1(50)

ES-175R:MMN\_FM1 = ES-175R:MMN\_Stn | ES-184R:MMN\_Stn &  
 ES-205D:\_MN\_Stn & ES-212D:\_MN\_Stn & ES-216D:\_MN\_Stn &  
 ES-222D:\_MN\_Stn | ES-172R:\_MN\_Stn | ES-175R:\_MN\_Q\_1(1) |  
 ES-175R:\_MN\_Q\_1(3) | ES-175R:\_MNHP\_1(40)

ES-181R:\_MS\_FM1 = ES-181R:MMS\_Stn | ES-165D:\_MS\_Stn &  
 ES-170D:\_MS\_Stn & ES-179D:\_MS\_Stn | ES-182R:MMS\_Stn |  
 ES-181R:\_MS\_Q\_1(1) & ES-181R:\_MS\_Q\_2(1) | ES-181R:\_MSRA\_1(2) &  
 ES-181R:\_MSRA\_2(2) | ES-181R:\_MSHP\_2(25)

ES-181R:\_MS\_FM2 = ES-181R:MMS\_Stn | ES-165D:\_MS\_Stn &  
 ES-170D:\_MS\_Stn & ES-179D:\_MS\_Stn | ES-182R:MMS\_Stn |  
 ES-181R:\_MS\_Q\_1(1) & ES-181R:\_MS\_Q\_2(1) | ES-181R:\_MSRA\_1(2) &  
 ES-181R:\_MSRA\_2(2) | ES-181R:\_MSHP\_2(25)

ES-182R:\_MS\_FM1 = ES-181R:MMS\_Stn | ES-165D:\_MS\_Stn &  
 ES-170D:\_MS\_Stn & ES-179D:\_MS\_Stn | ES-182R:MMS\_Stn |  
 ES-182R:\_MS\_Q\_1(2) | ES-182R:\_MSRA\_1(1) | ES-182R:\_MSHP\_2(25)

ES-182R:\_MS\_FM2 = ES-181R:MMS\_Stn | ES-165D:\_MS\_Stn &  
 ES-170D:\_MS\_Stn & ES-179D:\_MS\_Stn | ES-182R:MMS\_Stn |  
 ES-182R:\_MS\_Q\_2(2) | ES-182R:\_MSRA\_2(1) | ES-182R:\_MSHP\_2(25)

ES-184R:MMN\_FM1 = ES-184R:MMN\_Stn | ES-186D:\_MN\_Stn &  
 ES-205D:\_MN\_Stn & ES-212D:\_MN\_Stn & ES-216D:\_MN\_Stn &  
 ES-222D:\_MN\_Stn | ES-181R:\_MN\_Stn | ES-184R:\_MN\_Q\_1(2) |  
 ES-184R:\_MNRA\_1(2) | ES-184R:\_MNHP\_1(50)

ES-187R:MMS\_FM2 = ES-187R:MMS\_Stn | ES-165D:\_MS\_Stn &  
 ES-170D:\_MS\_Stn & ES-179D:\_MS\_Stn & ES-181R:MMS\_Stn &  
 ES-186D:\_MS\_Stn | ES-189D:\_MS\_Stn | ES-187R:\_MS\_I\_2(1) |  
 ES-187R:\_MSRA\_2(1) | ES-187R:\_MSHP\_2(50)

ES-188R:MMN\_FM1 = ES-188R:MMN\_Stn | ES-205D:\_MN\_Stn &  
 ES-212D:\_MN\_Stn & ES-216D:\_MN\_Stn & ES-222D:\_MN\_Stn |  
 ES-186D:\_MN\_Stn | ES-188R:\_MN\_Q\_1(1) & ES-188R:\_MN\_Q\_2(1) |  
 ES-188R:\_MNRA\_1(1) & ES-188R:\_MNLA\_1(1) & ES-188R:\_MNRA\_2(1) |  
 ES-188R:\_MNHP\_2(35)

ES-188R:MMN\_FM2 = ES-188R:MMN\_Stn | ES-205D:\_MN\_Stn &  
ES-212D:\_MN\_Stn & ES-216D:\_MN\_Stn & ES-222D:\_MN\_Stn |  
ES-186D:\_MN\_Stn | ES-188R:\_MN\_Q\_1(1) & ES-188R:\_MN\_Q\_2(1) |  
ES-188R:\_MNRA\_1(1) & ES-188R:\_MNLA\_1(1) & ES-188R:\_MNRA\_2(1) |  
ES-188R:\_MNHP\_2(35)

ES-193R:MMS\_FM1 = ES-193R:MMS\_Stn | ES-165D:\_MS\_Stn &  
ES-170D:\_MS\_Stn & ES-179D:\_MS\_Stn & ES-181R:MMS\_Stn &  
ES-186D:\_MS\_Stn | ES-201D:\_MS\_Stn | ES-193R:\_MS\_Q\_1(1) &  
ES-193R:\_MS\_Q\_2(1) | ES-193R:\_MSRA\_1(1) & ES-193R:\_MSRA\_2(1) |  
ES-193R:\_MSHP\_1(25)

ES-193R:MMS\_FM2 = ES-193R:MMS\_Stn | ES-165D:\_MS\_Stn &  
ES-170D:\_MS\_Stn & ES-179D:\_MS\_Stn & ES-181R:MMS\_Stn &  
ES-186D:\_MS\_Stn | ES-201D:\_MS\_Stn | ES-193R:\_MS\_Q\_1(1) &  
ES-193R:\_MS\_Q\_2(1) | ES-193R:\_MSRA\_1(1) & ES-193R:\_MSRA\_2(1) |  
ES-193R:\_MSHP\_1(25)

ES-195R:MMS\_FM1 = ES-195R:MMS\_Stn | ES-165D:\_MS\_Stn &  
ES-170D:\_MS\_Stn & ES-179D:\_MS\_Stn & ES-181R:MMS\_Stn &  
ES-186D:\_MS\_Stn & ES-193R:MMS\_Stn | ES-201D:\_MS\_Stn |  
ES-195R:\_MS\_I\_1(1) | ES-195R:\_MSRA\_1(1) & ES-195R:\_MSLA\_1(1) |  
ES-195R:\_MSHP\_1(50)

ES-199R:MMN\_FM1 = ES-199R:MMN\_Stn | ES-205D:\_MN\_Stn &  
ES-212D:\_MN\_Stn & ES-216D:\_MN\_Stn & ES-222D:\_MN\_Stn |  
ES-196D:\_MN\_Stn | ES-199R:\_MN\_I\_1(1) & ES-199R:\_MNRA\_2(1) |  
ES-199R:\_MNRA\_1(2)

ES-199R:MMN\_FM2 = ES-199R:MMN\_Stn | ES-205D:\_MN\_Stn &  
 ES-212D:\_MN\_Stn & ES-216D:\_MN\_Stn & ES-222D:\_MN\_Stn |  
 ES-196D:\_MN\_Stn | ES-199R:\_MN\_I\_1(1) & ES-199R:\_MNRA\_2(1) |  
 ES-199R:\_MNRA\_1(2)

ES-200R:MMN\_FM1 = ES-200R:MMN\_Stn | ES-205D:\_MN\_Stn &  
 ES-212D:\_MN\_Stn & ES-216D:\_MN\_Stn & ES-222D:\_MN\_Stn |  
 ES-199R:MMN\_Stn | ES-200R:\_MN\_Q\_1(1) & ES-200R:\_MN\_Q\_2(1) |  
 ES-200R:\_MNRA\_1(1) & ES-200R:\_MNRA\_2(1)

ES-200R:MMN\_FM2 = ES-200R:MMN\_Stn | ES-205D:\_MN\_Stn &  
 ES-212D:\_MN\_Stn & ES-216D:\_MN\_Stn & ES-222D:\_MN\_Stn |  
 ES-199R:MMN\_Stn | ES-200R:\_MN\_Q\_1(1) & ES-200R:\_MN\_Q\_2(1) |  
 ES-200R:\_MNRA\_1(1) & ES-200R:\_MNRA\_2(1)

ES-203R:MMS\_FM1 = ES-203R:MMS\_Stn | ES-165D:\_MS\_Stn &  
 ES-179D:\_MS\_Stn & ES-181R:MMS\_Stn & ES-186D:\_MS\_Stn &  
 ES-193R:MMS\_Stn & ES-196D:\_MS\_Stn | ES-205D:\_MS\_Stn |  
 ES-203R:\_MS\_Q\_1(2) | ES-203R:\_MSRA\_1(1) | ES-203R:\_MSHP\_1(30)

ES-203R:MMS\_FM2 = ES-203R:MMS\_Stn | ES-165D:\_MS\_Stn &  
 ES-179D:\_MS\_Stn & ES-181R:MMS\_Stn & ES-186D:\_MS\_Stn &  
 ES-193R:MMS\_Stn & ES-196D:\_MS\_Stn | ES-205D:\_MS\_Stn |  
 ES-203R:\_MS\_Q\_2(2) | ES-203R:\_MSRA\_2(1) | ES-203R:\_MSHP\_1(20)

ES-207R:MMS\_FM2 = ES-207R:MMS\_Stn | ES-179D:\_MS\_Stn &  
 ES-181R:MMS\_Stn & ES-186D:\_MS\_Stn & ES-196D:\_MS\_Stn |  
 ES-209D:\_MS\_Stn | ES-207R:\_MS\_Q\_2(2) | ES-207R:\_MSRA\_2(3) |  
 ES-207R:\_MSHP\_2(30)

ES-213R:MMS\_FM1 = ES-213R:MMS\_Stn | ES-181R:MMS\_Stn &  
 ES-186D:\_MS\_Stn & ES-196D:\_MS\_Stn & ES-207R:MMS\_Stn |  
 ES-215D:\_MS\_Stn | ES-213R:\_MS\_Q\_1(1) & ES-213R:\_MS\_Q\_2(1) |  
 ES-213R:\_MSRA\_1(4) & ES-213R:\_MSRA\_2(4) | ES-213R:\_MSHP\_1(25)

ES-213R:MMS\_FM2 = ES-213R:MMS\_Stn | ES-181R:MMS\_Stn &  
 ES-186D:\_MS\_Stn & ES-196D:\_MS\_Stn & ES-207R:MMS\_Stn |  
 ES-215D:\_MS\_Stn | ES-213R:\_MS\_Q\_1(1) & ES-213R:\_MS\_Q\_2(1) |  
 ES-213R:\_MSRA\_1(4) & ES-213R:\_MSRA\_2(4) | ES-213R:\_MSHP\_1(25)

ES-310R:MMN\_FM1 = ES-310R:MMN\_Stn | ES-338D:\_MN\_Stn &  
 ES-333D:\_MN\_Stn & ES-331D:\_MN\_Stn & ES-317D:\_MN\_Stn |  
 ES-311D:\_MN\_Stn | ES-310R:\_MN\_Q\_1(2) | ES-310R:\_MNRA\_1(2)

ES-315R:MMS\_FM1 = ES-315R:MMS\_Stn | ES-314D:\_MS\_Stn &  
 ES-310R:\_MS\_Stn | ES-317D:\_MS\_Stn | ES-315R:\_MS\_Q\_1(2) |  
 ES-315R:\_MSRA\_1(2)

ES-316R:MMN\_FM1 = ES-316R:MMN\_Stn | ES-338D:\_MN\_Stn &  
 ES-333D:\_MN\_Stn & ES-331D:\_MN\_Stn & ES-317D:\_MN\_Stn |  
 ES-314D:\_MN\_Stn | ES-316R:\_MN\_Q\_1(2) | ES-316R:\_MNRA\_1(2)

ES-320R:MMS\_FM1 = ES-320R:MMS\_Stn | ES-319D:\_MS\_Stn &  
 ES-314D:\_MS\_Stn & ES-310R:\_MS\_Stn & ES-317D:\_MS\_Stn |  
 ES-322D:\_MS\_Stn | ES-320R:\_MS\_Q\_1(1) & ES-320R:\_MS\_Q\_2(1) |  
 ES-320R:\_MSRA\_1(1) & ES-320R:\_MSRA\_2(1)

ES-320R:MMS\_FM2 = ES-320R:MMS\_Stn | ES-319D:\_MS\_Stn &  
 ES-314D:\_MS\_Stn & ES-310R:\_MS\_Stn & ES-317D:\_MS\_Stn |  
 ES-322D:\_MS\_Stn | ES-320R:\_MS\_Q\_1(1) & ES-320R:\_MS\_Q\_2(1) |  
 ES-320R:\_MSRA\_1(1) & ES-320R:\_MSRA\_2(1)

ES-321R:MMN\_FM1 = ES-321R:MMN\_Stn | ES-338D:\_MN\_Stn &  
 ES-333D:\_MN\_Stn & ES-331D:\_MN\_Stn | ES-319D:\_MN\_Stn |  
 ES-321R:\_MN\_Q\_1(2) | ES-321R:\_MNRA\_1(2)

ES-325R:MMS\_FM1 = ES-325R:MMS\_Stn | ES-319D:\_MS\_Stn &  
 ES-317D:\_MS\_Stn & ES-314D:\_MS\_Stn & ES-310R:\_MS\_Stn |  
 ES-327D:\_MS\_Stn | ES-325R:\_MS\_Q\_1(1) | ES-325R:\_MS\_Q\_1(3)

ES-326R:MMN\_FM1 = ES-326R:MMN\_Stn | ES-338D:\_MN\_Stn &  
 ES-333D:\_MN\_Stn & ES-331D:\_MN\_Stn | ES-324D:\_MN\_Stn |  
 ES-326R:\_MN\_I\_1(2) | ES-326R:\_MNRA\_1(2) | ES-326R:\_MNHP\_1(50)

ES-329R:MMN\_FM1 = ES-329R:MMN\_Stn | ES-338D:\_MN\_Stn &  
 ES-333D:\_MN\_Stn & ES-331D:\_MN\_Stn | ES-327D:\_MN\_Stn |  
 ES-329R:\_MN\_Q\_1(2) | ES-329R:\_MNRA\_1(2)

ES-335R:MMN\_FM1 = ES-335R:MMN\_Stn | ES-338D:\_MN\_Stn &  
 ES-336D:\_MN\_Stn | ES-333D:\_MN\_Stn | ES-335R:\_MN\_Q\_1(2) |  
 ES-335R:\_MNRA\_1(2)

ES-504R:MME\_FM2 = ES-504R:MME\_Stn & ES-506R:MME\_Stn |  
 ES-506R:MME\_Stn & ES-514D:\_ME\_Stn & ES-519R:MME\_Stn |  
 ES-502D:\_ME\_Stn |  
 ES-504R:\_ME\_I\_2(2) | ES-504R:\_MERA\_2(2) | ES-504R:\_MEHP\_2(50)

ES-506R:MME\_FM2 = ES-506R:MME\_Stn | ES-514D:\_ME\_Stn &  
 ES-519R:MME\_Stn | ES-504R:MME\_Stn | ES-506R:\_ME\_Q\_2(2) |  
 ES-506R:\_MERA\_2(2)

ES-616R:MMS\_FM2 = ES-616R:MMS\_\_\_1 | ES-612D:\_MS\_Stn |  
 ES-619D:\_MS\_Stn | ES-616R:\_MS\_Q\_2(1) | ES-616R:\_MSLA\_2(3) &  
 ES-616R:\_MSRA\_2(2) | ES-616R:\_MSHP\_2(60)



ES-617R:MMN\_FM1 = ES-617R:MMN\_Stn | ES-619D:\_MN\_Stn &  
 ES-630D:\_MN\_Stn & ES-638R:MMN\_Stn & ES-643R:MMN\_Stn |  
 ES-614D:\_MN\_Stn | ES-617R:\_MN\_Q\_1(1) | ES-617R:\_MNLA\_1(3) &  
 ES-617R:\_MNRA\_1(2) | ES-617R:\_MNHP\_1(60)

ES-634R:MMN\_FM1 = ES-634R:MMN\_Stn | ES-638R:MMN\_Stn &  
 ES-643R:MMN\_Stn & ES-648R:MMN\_Stn & ES-654R:MMN\_Stn &  
 ES-662R:\_MN\_Stn | ES-628D:\_MN\_Stn | ES-634R:\_MN\_Q\_1(1) |  
 ES-634R:\_MNRA\_1(2)

ES-638R:MMN\_FM2 = ES-638R:MMN\_Stn | ES-643R:MMN\_Stn &  
 ES-648R:MMN\_Stn & ES-654R:MMN\_Stn & ES-662R:\_MN\_Stn |  
 ES-634R:MMN\_Stn | ES-638R:\_MN\_Q\_2(2) | ES-638R:\_MNLA\_2(3)

ES-642R:MMS\_FM1 = ES-642R:MMS\_Stn | ES-612D:\_MS\_Stn &  
 ES-619D:\_MS\_Stn & ES-630D:\_MS\_Stn & ES-633R:MMS\_Stn |  
 ES-645D:\_MS\_Stn | ES-642R:\_MS\_Q\_1(1) | ES-642R:\_MSRA\_1(2) |  
 ES-642R:\_MSHP\_1(60)

ES-643R:MMN\_FM1 = ES-643R:MMN\_Stn | ES-648R:MMN\_Stn &  
 ES-654R:MMN\_Stn & ES-662R:\_MN\_Stn | ES-638R:MMN\_Stn |  
 ES-643R:\_MN\_Q\_1(1) | ES-643R:\_MNRA\_1(2) | ES-643R:\_MNHP\_1(60)

ES-647R:MMS\_FM2 = ES-647R:MMS\_Stn | ES-630D:\_MS\_Stn &  
 ES-633R:MMS\_Stn & ES-642R:MMS\_Stn | ES-651D:\_MS\_Stn |  
 ES-647R:\_MS\_Q\_2(1) | ES-647R:\_MS\_Q\_2(3)

ES-648R:MMN\_FM1 = ES-648R:MMN\_Stn | ES-654R:MMN\_Stn &  
 ES-662R:\_MN\_Stn & ES-665D:\_MN\_Stn | ES-643R:MMN\_Stn |  
 ES-648R:\_MN\_Q\_1(1) | ES-648R:\_MNRA\_1(2) | ES-648R:\_MNHP\_1(60)

ES-653R:MMS\_FM1 = ES-653R:MMS\_Stn | ES-630D:\_MS\_Stn &  
     ES-642R:MMS\_Stn & ES-651D:\_MS\_Stn | ES-656D:\_MS\_Stn |  
     ES-653R:\_MS\_Q\_1(1) | ES-653R:\_MSRA\_1(2) | ES-653R:\_MSHP\_1(60)

ES-654R:MMN\_FM1 = ES-654R:MMN\_Stn | ES-656D:\_MN\_Stn &  
     ES-662R:\_MN\_Stn & ES-665D:\_MN\_Stn & ES-667D:\_MN\_Stn &  
     ES-672D:\_MN\_Stn | ES-648R:MMN\_Stn | ES-654R:\_MN\_Q\_1(1) |  
     ES-654R:\_MN\_Q\_1(3)

ES-662R:MMS\_FM2 = ES-662R:MMS\_Stn | ES-630D:\_MS\_Stn &  
     ES-642R:MMS\_Stn & ES-651D:\_MS\_Stn & ES-653R:MMS\_Stn |  
     ES-665D:\_MS\_Stn | ES-662R:\_MS\_Q\_2(1) | ES-662R:\_MS\_Q\_2(3)

ES-681R:MMS\_FM1 = ES-681R:MMS\_Stn | ES-667D:\_MS\_Stn &  
     ES-678D:\_MS\_Stn | ES-684D:\_MS\_Stn | ES-681R:\_MS\_Q\_1(1) |  
     ES-681R:\_MSRA\_1(2) | ES-681R:\_MSHP\_1(60)

ES-682R:MMN\_FM1 = ES-682R:MMN\_Stn | ES-687R:MMN\_Stn &  
     ES-696D:\_MN\_Stn & ES-694R:MMN\_Stn | ES-678D:\_MN\_Stn |  
     ES-682R:\_MN\_Q\_1(1) | ES-682R:\_MNRA\_1(2) | ES-682R:\_MNHP\_1(60)

ES-687R:MMN\_FM1 = ES-687R:MMN\_Stn | ES-696D:\_MN\_Stn &  
     ES-694R:MMN\_Stn | ES-684D:\_MN\_Stn | ES-687R:\_MN\_Q\_1(1) |  
     ES-687R:\_MNRA\_1(2) | ES-687R:\_MNHP\_1(60)

ES-689R:MMS\_FM1 = ES-689R:MMS\_Stn | ES-667D:\_MS\_Stn &  
     ES-678D:\_MS\_Stn & ES-681R:MMS\_Stn & ES-684D:\_MS\_Stn |  
     ES-696D:\_MS\_Stn | ES-689R:\_MS\_Q\_1(1) & ES-689R:\_MS\_Q\_2(1) |  
     ES-689R:\_MSRA\_1(2) & ES-689R:\_MSRA\_2(2) | ES-689R:\_MSHP\_3(20)

ES-689R:MMS\_FM2 = ES-689R:MMS\_Stn | ES-667D:\_MS\_Stn &  
     ES-678D:\_MS\_Stn & ES-681R:MMS\_Stn & ES-684D:\_MS\_Stn |  
     ES-696D:\_MS\_Stn | ES-689R:\_MS\_Q\_1(1) & ES-689R:\_MS\_Q\_2(1) |  
     ES-689R:\_MSRA\_1(2) & ES-689R:\_MSRA\_2(2) | ES-689R:\_MSHP\_3(20)

ES-689R:MMS\_FM3 = ES-689R:MMS\_Stn | ES-667D:\_MS\_Stn &  
     ES-678D:\_MS\_Stn & ES-681R:MMS\_Stn & ES-684D:\_MS\_Stn |  
     ES-696D:\_MS\_Stn | ES-689R:\_MS\_Q\_3(1) | ES-689R:\_MSRA\_3(2) |  
     ES-689R:\_MSHP\_3(20)

ES-693R:MMN\_FM2 = ES-694R:MMN\_Stn | ES-696D:\_MN\_Stn |  
     ES-693R:MMN\_Stn | ES-693R:\_CN\_Q\_2(1) | ES-693R:\_CNRA\_2(2) |  
     ES-693R:\_CNHP\_2(30)

ES-694R:MMN\_FM2 = ES-694R:MMN\_Stn | ES-696D:\_MN\_Stn |  
     ES-693R:MMN\_Stn | ES-694R:\_CN\_Q\_2(1) | ES-694R:\_CNRA\_2(2) |  
     ES-694R:\_CNHP\_2(30)

ES-710R:MMS\_FM1 = ES-710R:MMS\_Stn | ES-709D:\_MS\_Stn |  
     ES-717R:\_MS\_Stn | ES-710R:\_MS\_Q\_1(1) | ES-710R:\_MSRA\_1(2) |  
     ES-710R:\_MSHP\_1(50)

ES-711R:MMN\_FM1 = ES-711R:MMN\_Stn | ES-720D:\_MN\_Stn &  
     ES-724D:\_MN\_Stn & ES-731R:MMN\_Stn & ES-742D:\_MN\_Stn |  
     ES-710R:\_MN\_Stn | ES-711R:\_MN\_Q\_1(1) & ES-711R:\_MN\_Q\_2(1) |  
     ES-711R:\_MNRA\_1(2) | ES-711R:\_MNHP\_1(30)

ES-711R:MMN\_FM2 = ES-711R:MMN\_Stn | ES-720D:\_MN\_Stn &  
     ES-724D:\_MN\_Stn & ES-731R:MMN\_Stn & ES-742D:\_MN\_Stn |  
     ES-710R:\_MN\_Stn | ES-711R:\_MN\_Q\_1(1) & ES-711R:\_MN\_Q\_2(1) |  
     ES-711R:\_MNRA\_1(2) | ES-711R:\_MNHP\_1(30)

ES-716R:MMS\_FM1 = ES-716R:MMS\_Stn | ES-709D:\_MS\_Stn &  
     ES-711R:\_MS\_Stn | ES-717R:\_MS\_Stn | ES-716R:\_CS\_Q\_1(1) |  
     ES-716R:\_CSRA\_1(1) | ES-716R:\_CSHP\_2(20)

ES-716R:MMS\_FM2 = ES-716R:MMS\_Stn | ES-709D:\_MS\_Stn &  
     ES-711R:\_MS\_Stn | ES-717R:\_MS\_Stn | ES-716R:\_CS\_Q\_2(1) |  
     ES-716R:\_CS\_Q\_2(1) | ES-716R:\_CSHP\_2(30)

ES-717R:MMN\_FM1 = ES-717R:MMN\_Stn | ES-720D:\_MN\_Stn &  
     ES-724D:\_MN\_Stn & ES-731R:MMN\_Stn & ES-742D:\_MN\_Stn |  
     ES-716R:\_MN\_Stn | ES-717R:\_CN\_Q\_1(2) | ES-717R:\_CNRA\_1(2) |  
     ES-717R:\_CNHP\_2(30)

ES-717R:MMN\_FM2 = ES-717R:MMN\_Stn | ES-720D:\_MN\_Stn &  
     ES-724D:\_MN\_Stn & ES-731R:MMN\_Stn & ES-742D:\_MN\_Stn |  
     ES-716R:\_MN\_Stn | ES-717R:\_CN\_Q\_2(2) | ES-717R:\_CNRA\_2(2) |  
     ES-717R:\_CNHP\_2(30)

ES-726R:MMS\_FM1 = ES-726R:MMS\_Stn | ES-709D:\_MS\_Stn &  
     ES-722D:\_MS\_Stn & ES-724D:\_MS\_Stn | ES-734D:\_MS\_Stn |  
     ES-726R:\_MS\_Q\_1(1) | ES-726R:\_MSRA\_1(1) | ES-726R:\_MSHP\_2(25)

ES-726R:MMS\_FM2 = ES-726R:MMS\_Stn | ES-709D:\_MS\_Stn &  
     ES-722D:\_MS\_Stn & ES-724D:\_MS\_Stn | ES-734D:\_MS\_Stn |  
     ES-726R:\_MS\_Q\_2(1) | ES-726R:\_MSRA\_1(1) | ES-726R:\_MSHP\_2(25)

ES-730R:MMS\_FM1 = ES-730R:MMS\_Stn | ES-709D:\_MS\_Stn &  
     ES-722D:\_MS\_Stn & ES-724D:\_MS\_Stn | ES-731R:\_MS\_Stn |  
     ES-730R:\_MS\_Q\_1(1) & ES-730R:\_MS\_Q\_2(1) | ES-730R:\_MSRA\_1(1) |  
     ES-730R:\_MSHP\_2(20)

ES-730R:MMS\_FM2 = ES-730R:MMS\_Stn | ES-709D:\_MS\_Stn &  
 ES-722D:\_MS\_Stn & ES-724D:\_MS\_Stn | ES-731R:\_MS\_Stn |  
 ES-730R:\_MS\_Q\_1(1) & ES-730R:\_MS\_Q\_2(1) | ES-730R:\_MSRA\_1(1) |  
 ES-730R:\_MSHP\_2(20)

ES-730R:MMS\_FM3 = ES-730R:MMS\_Stn | ES-709D:\_MS\_Stn &  
 ES-722D:\_MS\_Stn & ES-724D:\_MS\_Stn | ES-731R:\_MS\_Stn |  
 ES-730R:\_MS\_Q\_3(1) | ES-730R:\_MSRA\_3(4) | ES-730R:\_MSHP\_2(10)

ES-731R:MMN\_FM1 = ES-731R:MMN\_Stn | ES-736D:\_MN\_Stn &  
 ES-742D:\_MN\_Stn | ES-730R:\_MN\_Stn | ES-731R:\_MN\_Q\_1(2) |  
 ES-731R:\_MNRA\_1(2)

ES-731R:MMN\_FM2 = ES-731R:MMN\_Stn | ES-736D:\_MN\_Stn &  
 ES-742D:\_MN\_Stn | ES-730R:\_MN\_Stn | ES-731R:\_MN\_Q\_2(2) |  
 ES-731R:\_MNRA\_2(2)

ES-731R:MMN\_FM3 = ES-731R:MMN\_Stn | ES-736D:\_MN\_Stn &  
 ES-742D:\_MN\_Stn | ES-730R:\_MN\_Stn | ES-731R:\_MN\_Q\_3(2) |  
 ES-731R:\_MNRA\_3(2)

ES-740R:MMS\_FM1 = ES-740R:MMS\_Stn | ES-730R:MMS\_Stn &  
 ES-722D:\_MS\_Stn | ES-742D:\_MS\_Stn | ES-740R:\_MS\_Q\_1(2) |  
 ES-740R:\_MS\_I\_1(1) | ES-740R:\_MSHP\_1(50)

ES-741R:MMN\_FM1 = ES-741R:MMN\_Stn | ES-742D:\_MN\_Stn |  
 ES-740R:\_MN\_Stn | ES-741R:\_MN\_Q\_1(2) | ES-741R:\_MNRA\_1(2) |  
 ES-741R:\_MNHP\_1(60)

ES-822R:MME\_FM2 = ES-822R:MME\_Stn | ES-825R:MME\_Stn &  
 ES-858D:\_ME\_Stn & ES-876R:\_ME\_Stn & ES-883D:\_ME\_Stn &  
 ES-889R:MME\_Stn | ES-820D:\_ME\_Stn | ES-822R:\_ME\_Q\_2(1) |  
 ES-822R:\_MERA\_2(2) | ES-822R:\_MEHP\_2(50)

ES-825R:MME\_FM1 = ES-825R:MME\_Stn | ES-858D:\_ME\_Stn &  
 ES-876R:\_ME\_Stn & ES-883D:\_ME\_Stn & ES-889R:MME\_Stn |  
 ES-820D:\_ME\_Stn | ES-825R:\_ME\_Q\_1(1) | ES-825R:\_MERA\_1(2) |  
 ES-825R:\_MEHP\_1(50)

ES-863R:MMW\_FM2 = ES-863R:MMW\_Stn | ES-857D:\_MW\_Stn &  
 ES-820D:\_MW\_Stn | ES-876R:MMW\_Stn | ES-863R:\_MW\_Q\_2(1) |  
 ES-863R:\_MWRA\_2(2) | ES-863R:\_MWHP\_2(50)

ES-876R:MMW\_FM2 = ES-876R:MMW\_Stn | ES-863R:MMW\_Stn &  
 ES-857D:\_MW\_Stn & ES-820D:\_MW\_Stn | ES-879R:MMW\_Stn |  
 ES-876R:\_MW\_Q\_2(1) | ES-876R:\_MWRA\_2(2) & ES-876R:\_MWLA\_2(2)

ES-879R:MMW\_FM2 = ES-879R:MMW\_Stn | ES-863R:MMW\_Stn &  
 ES-857D:\_MW\_Stn & ES-820D:\_MW\_Stn | ES-883D:\_MW\_Stn |  
 ES-879R:\_MW\_Q\_2(1) | ES-879R:\_MWRA\_2(2) & ES-879R:\_MWLA\_2(2)

ES-881R:MME\_FM2 = ES-881R:MME\_Stn | ES-883D:\_ME\_Stn &  
 ES-889R:MME\_Stn & ES-935R:\_ME\_Stn & ES-945R:\_ME\_Stn |  
 ES-876R:\_ME\_Stn | ES-881R:\_ME\_Q\_2(1) | ES-881R:\_MERA\_2(2) &  
 ES-881R:\_MELA\_2(2)

ES-887R:MMW\_FM2 = ES-887R:MMW\_Stn | ES-883D:\_MW\_Stn &  
 ES-863R:MMW\_Stn & ES-857D:\_MW\_Stn & ES-820D:\_MW\_Stn |  
 ES-891D:\_MW\_Stn | ES-887R:\_MW\_Q\_2(1) | ES-887R:\_MW\_Q\_2(3) |  
 ES-887R:\_MWHP\_2(50)

ES-889R:MME\_FM2 = ES-889R:MME\_Stn | ES-935R:\_ME\_Stn &  
 ES-945R:\_ME\_Stn | ES-885D:\_ME\_Stn | ES-889R:\_ME\_Q\_2(1) |  
 ES-889R:\_MERA\_2(2) & ES-889R:\_MELA\_2(2) | ES-889R:\_MEHP\_2(50)

ES-893R:MMW\_FM2 = ES-893R:MMW\_Stn | ES-891D:\_MW\_Stn &  
 ES-883D:\_MW\_Stn & ES-863R:MMW\_Stn & ES-857D:\_MW\_Stn &  
 ES-820D:\_MW\_Stn | ES-896D:\_MW\_Stn | ES-893R:\_MW\_Q\_2(1) |  
 ES-893R:\_MWRA\_2(2) | ES-893R:\_MWHP\_2(50)

ES-900R:MMW\_FM1 = ES-900R:MMW\_Stn | ES-893R:MMW\_Stn &  
 ES-891D:\_MW\_Stn & ES-887R:MMW\_Stn & ES-879R:MMW\_Stn &  
 ES-876R:MMW\_Stn | ES-908R:MMW\_Stn | ES-900R:\_MW\_Q\_1(2)|  
 ES-900R:\_MWRA\_1(2)| ES-900R:\_MWHP\_2(15)

ES-900R:MMW\_FM2 = ES-900R:MMW\_Stn | ES-893R:MMW\_Stn &  
 ES-891D:\_MW\_Stn & ES-887R:MMW\_Stn & ES-879R:MMW\_Stn &  
 ES-876R:MMW\_Stn | ES-908R:MMW\_Stn | ES-900R:\_MW\_Q\_2(2) |  
 ES-900R:\_MWRA\_2(2) | ES-900R:\_MWHP\_2(15)

ES-908R:\_MW\_FM1 = ES-908R:MMW\_Stn | ES-903D:\_MW\_Stn |  
 ES-910D:\_MW\_Stn | ES-908R:\_MW\_Q\_1(1) | ES-908R:\_MWRA\_1(1) |  
 ES-908R:\_MWHP\_1(25)

ES-908R:\_MW\_FM2 = ES-908R:MMW\_Stn | ES-903D:\_MW\_Stn |  
 ES-910D:\_MW\_Stn | ES-908R:\_MW\_Q\_2(1) | ES-908R:\_MWRA\_2(1) |  
 ES-908R:\_MWHP\_1(25)

ES-920R:MMW\_FM1 = ES-920R:MMW\_Stn |  
 ES-903D:\_MW\_Stn & ES-908R:MMW\_Stn & ES-916D:\_MW\_Stn |  
 ES-924D:\_MW\_Stn |  
 ES-920R:\_MW\_I\_1(1) & ES-920R:\_MW\_I\_2(1) |  
 ES-920R:\_MWRA\_1(1) & ES-920R:\_MWLA\_1(1) |  
 ES-920R:\_MWHP\_2(25)

ES-920R:MMW\_FM2 = ES-920R:MMW\_Stn |

ES-903D:\_MW\_Stn & ES-908R:MMW\_Stn & ES-916D:\_MW\_Stn |

ES-924D:\_MW\_Stn |

ES-920R:\_MW\_I\_1(1) & ES-920R:\_MW\_I\_2(1) |

ES-920R:\_MWRA\_1(1) & ES-920R:\_MWLA\_1(1) |

ES-920R:\_MWHP\_2(25)

ES-935R:MMW\_FM1 = ES-935R:MMW\_Stn | ES-903D:\_MW\_Stn &

ES-908R:MMW\_Stn & ES-916D:\_MW\_Stn & ES-920R:MMW\_Stn |

ES-940D:\_MW\_Stn | ES-935R:\_MW\_Q\_1(2) | ES-935R:\_MWRA\_1(1) |

ES-935R:\_MWHP\_1(50)

ES-935R:MMW\_FM2 = ES-935R:MMW\_Stn | ES-903D:\_MW\_Stn &

ES-908R:MMW\_Stn & ES-916D:\_MW\_Stn & ES-920R:MMW\_Stn |

ES-940D:\_MW\_Stn | ES-935R:\_MW\_Q\_2(2) | ES-935R:\_MWRA\_2(1) |

ES-935R:\_MWHP\_2(50)

ES-945R:MMW\_FM1 = ES-945R:MMW\_Stn | ES-903D:\_MW\_Stn &

ES-908R:MMW\_Stn & ES-916D:\_MW\_Stn & ES-920R:MMW\_Stn &

ES-935R:MMW\_Stn | ES-945R:MMW\_Stn | ES-945R:\_MW\_Q\_1(1) &

ES-945R:\_MW\_Q\_2(1) | ES-945R:\_MWRA\_1(1) & ES-945R:\_MWRA\_2(1) |

ES-945R:\_MWHP\_2(10)

ES-945R:MMW\_FM2 = ES-945R:MMW\_Stn | ES-903D:\_MW\_Stn &

ES-908R:MMW\_Stn & ES-916D:\_MW\_Stn & ES-920R:MMW\_Stn &

ES-935R:MMW\_Stn | ES-945R:MMW\_Stn | ES-945R:\_MW\_Q\_1(1) &

ES-945R:\_MW\_Q\_2(1) | ES-945R:\_MWRA\_1(1) & ES-945R:\_MWRA\_2(1) |

ES-945R:\_MWHP\_2(10)