

Emerging Concepts Working Group

Summary Report

July 23, 1999

Dan Barnes – Organizer

Adil Hassam, Jay Kesner – Physics Issues

Jim Hammer, Dick Siemon – Reactor Issues

Alan Hoffman, Bick Hooper – Next Step & Metrics

George Miley, John Slough – Technical Opportunities

THANKS TO ALL EC PARTICIPANTS!!!

Consensus of the Emerging Concept group is:

- ⟨ We endorse innovation at all levels and all aspects (physics, technology, new products, ...) of the national fusion program, including the recent Innovative Confinement Concepts (ICC) program and its contributions to the ST and compact stellarator concepts

- ⟨ We believe there is a need for a continuous vigorous supply of genuinely alternative concepts, which will provide the program with exciting technical opportunities during the decades-long development of fusion
 - **Emerging concepts search for features to make more attractive, flexible fusion systems**
 - + Reduce or eliminate B_T
 - + Reduce level and number of external controls
 - + Reduce energy for high-gain IFE ignition or reduce auxiliary heating
 - + Utilize more favorable spherical or linear geometry
 - + Utilize high or $\times \beta$, to allow for possible advanced fuel cycle
 - + Operate at intermediate density (\gg conventional MFE, \ll conventional IFE)
 - + ...

- ⟨ We strongly believe a healthy fusion program includes, as a matter of policy, a substantial component of EC research

We define emerging concepts as qualitatively different approaches from mainline fusion that offer the potential for less expensive and/or more rapid fusion energy development

Attributes of emerging concepts

- < Good science (peer review; consistency with previous knowledge)
- < Significantly different; not incremental improvements
- < Acceptance of high risk for high payoff
- < Often involve unfamiliar physics and/or technology
- < Sometimes contain features needed for advanced fuels or unique applications such as isotope production or space propulsion
- < Presently below Performance Enhancement stage

Mainline research [tokamaks, spherical torus, (compact) stellarators, conventional inertial fusion] has established the scientific credibility of fusion and a baseline for judging the development requirements for fusion power. Emerging concept research is predicated on the belief that there exist cheaper, better, faster routes to fusion and ultimately an improved end product. Additional value is derived from the cross fertilization of ideas from emerging and mainline concepts.

What's New and Exciting in Emerging Concepts

CONCEPT	
RFP	Five-fold increase in energy confinement by profile control
FRC	Stability at $R/\rho_i=4$, evidence of self-organization, rotating magnetic field current drive.
Ion Rings	Potential stabilizing element for FRC.
MTF	Dramatic advance in liner technology. Variety of suitable plasma targets with sufficient confinement.
Spheromak	Operating modes to minimize turbulence, modern wall conditioning.
Dipole	Simple magnetic field geometry. Theoretically shown to support high β with MHD and drift wave stability.
Centrifugal	Theoretical simulation of stability with flow shear indicates strong potential well formation.
Mirror/GDT	Novosibirsk GDT indicates $\beta=30\%$, classical behavior of sloshing ions and classical electrons at $T_e=150$ eV.
Electrostatic	Pulsating electrostatic trap (POPS) eliminates ion collisional isotropization.
Flow Pinch	Sheared flow stabilization.
Fast Igniter	High density pre compression followed by petawatt ignition pulse.

GAS-DYNAMIC TRAP (NOVOSIBIRSK)

FULLY AXISYMMETRIC MHD STABLE MIRROR MACHINE WITH A VERY HIGH MIRROR RATIO R (UP TO 75) AND COLLISIONAL IONS ($\lambda_{ii}/R < L$); $\tau_{ii} = RL/c_s$.

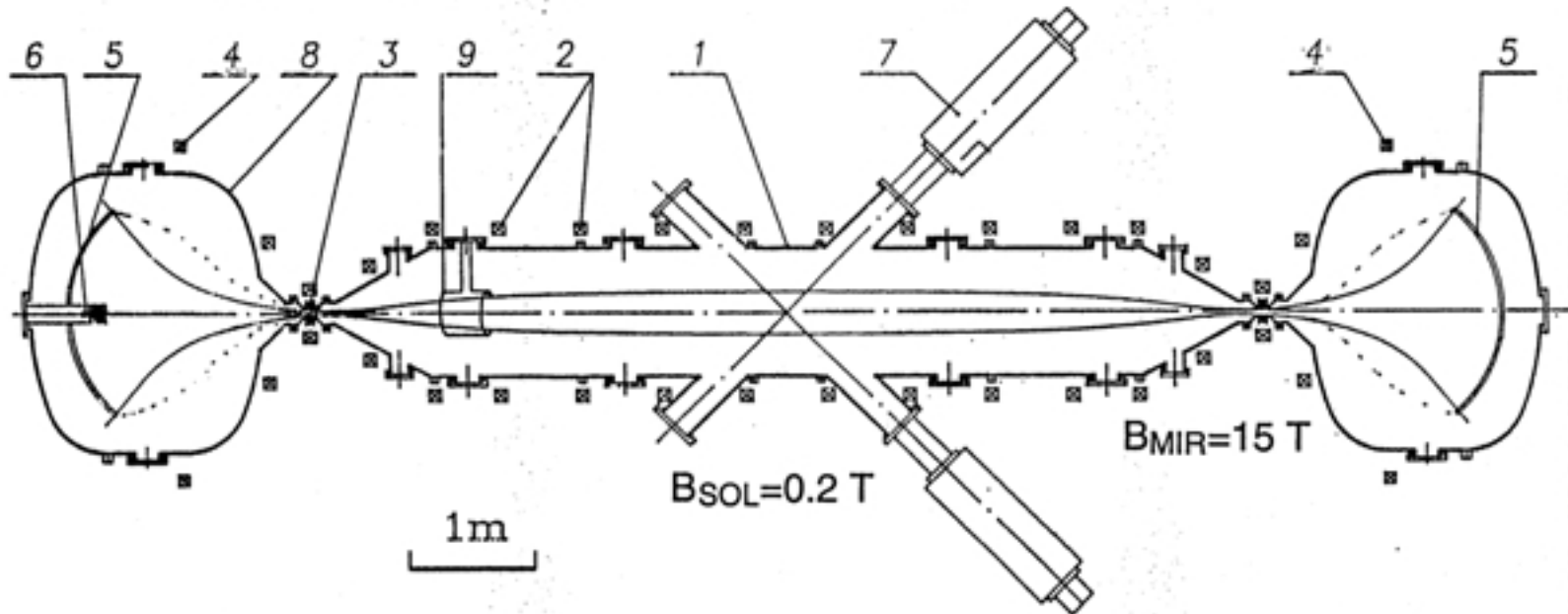

1-VACUUM CHAMBER
2-COILS OF THE SOLENOIDAL
MAGNETIC FIELD
3-MIRRORS
4-EXPANDER COILS

5-PLASMA ABSORBERS
6-PLASMA GUN
7-NB INJECTORS (6)
8-EXPANDERS
9-RF ANTENNA

Thanks to Dmitri Ryutov -- LLNL

Los Alamos National Laboratory -- Fusion Energy



SSPX -- Spheromak confinement



Guided by new understanding of old data

SSPX has:

- Separate formation and sustainment systems
- New operating modes to minimize turbulence
- Modern wall conditioning
- Profile diagnostics for n , T , B and fluctuations

Modern 3D resistive MHD Codes guide understanding and extrapolation

Thanks to Bick Hooper -- LLNL

Los Alamos National Laboratory -- Fusion Energy

Inertial Electrostatic Confinement Device with Star Mode Discharge

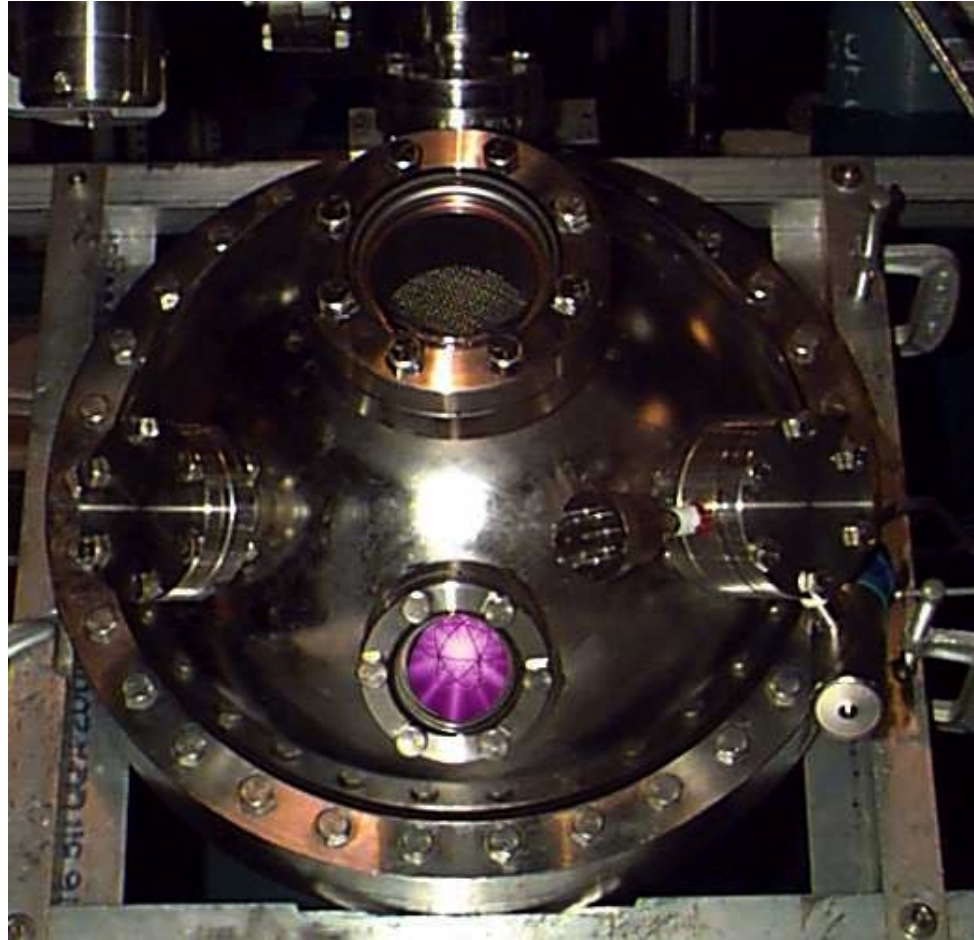

Thanks to George Miley -- Univ. of Illinois

Los Alamos National Laboratory -- Fusion Energy

FY99 MTF Liner test shots at Shiva-Star have been successfully completed

Radiographs $t = 0 \mu\text{s}$

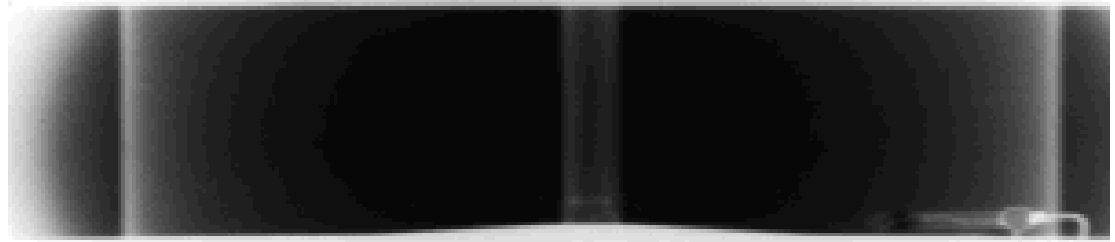

¥ *Two liner test shots at Shiva-Star*

D *10-cm diameter, 30-cm long 270 gm aluminum liners*

¥ *Symmetrically imploded to ~13:1 compression*

D *11 MA current*

D *1.4 MJ of liner kinetic energy in ~24 μsec .*

$t = 20 \mu\text{s}$

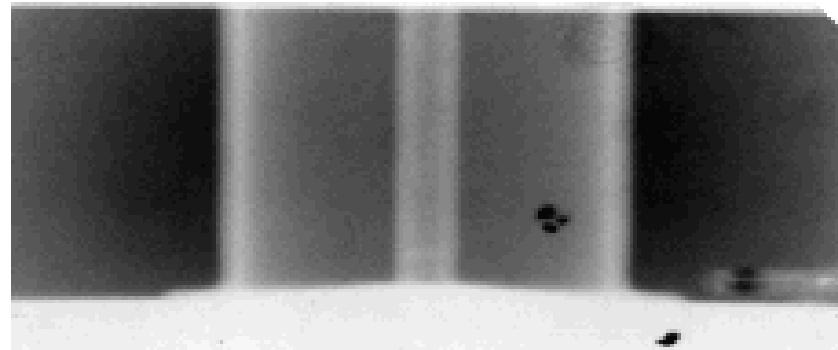

$t = 23.5 \mu\text{s}$

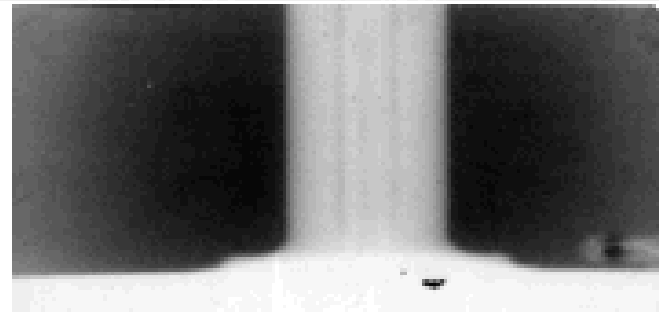

Thanks to the MTF team

Los Alamos National Laboratory -- Fusion Energy

Why is dipole confinement interesting?

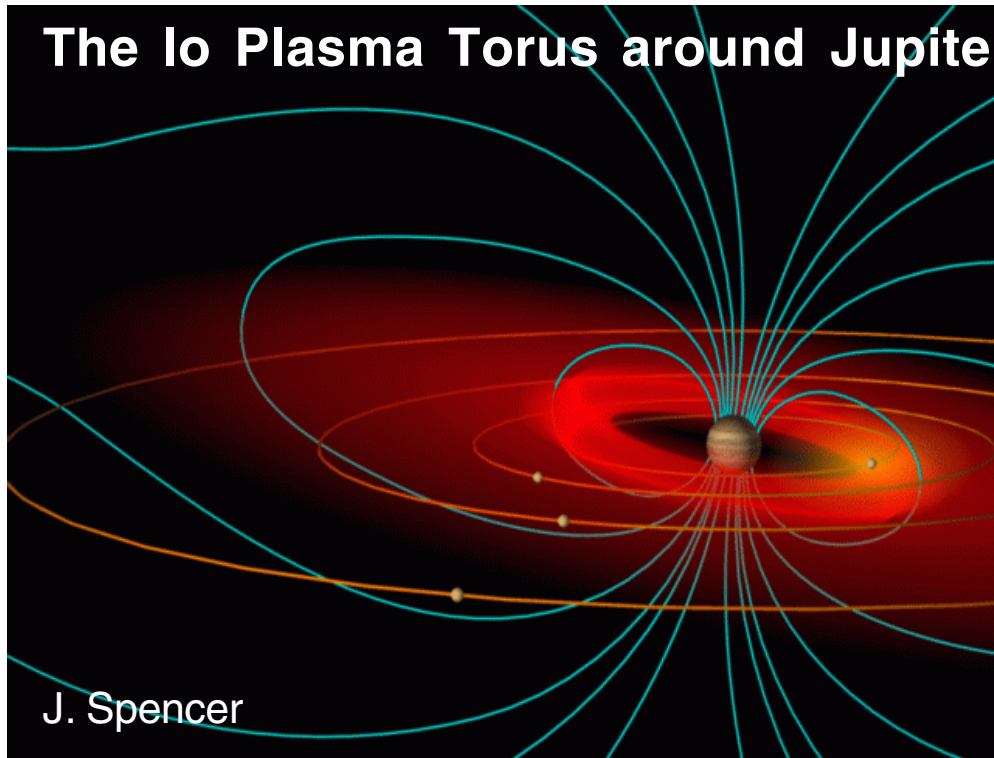

- Simplest confinement field
- High- β confinement occurs naturally in magnetospheres ($\beta \sim 2$ in Jupiter)
- Possibility of fusion power source with near-classical energy confinement
- Opportunity to study new physics relevant to fusion and space science

Thanks to Darren Garnier -- MIT

Los Alamos National Laboratory -- Fusion Energy

Physics Issues In Emerging Concepts

CONCEPT	PHYSICS ISSUES	PHYSICS OPPORTUNITIES
RFP	Relaxation and transport Current maintenance, current profile control	High β & low vacuum B_T
Spheromak	Relaxation and transport Helicity injection and current drive	Sustainment? continuous or pulsed
FRC	Stability at high R/ρ_i Transport, flux build up, optimal shape	Study kinetic effects, flow shear, density scaling, RMF effect.
Ion Rings	Ring current required for stability Current drive	Large orbit stabilization (of FRC, mirror, etc)
-----	-----	-----
Colliding beam	Maintain non-thermal distribution	Large-orbit effects
MTF	Target confinement – convection in target, fuel-liner mixing	High β , high B Uses FRC and other targets
Levitated Dipole	MHD stability from compressibility Convective cells, drift waves and transport	High β , high τ_E confinement Related to magnetospheric physics
Centrifugally confined plasmas	MHD stability using flow shear. Potential formation, electron parallel heat transport.	Absolute confinement in potential well
Mirror/GDT ($\lambda \ll L$)	Cross-field transport	Stable at high β , simplicity
-----	-----	-----
Tandem ($\lambda \gg L$)	T_e , non-axisymmetry & transport, potential formation	Stable at high β
Flow Pinch	MHD stability at high β with flow shear	Shear stabilization mechanism, simplicity

Physics Issues In Emerging Concepts

CONCEPT	KEY PHYSICS ISSUES	OPPORTUNITIES
Electrostatic IEC	Potential well formation, ion collisional isotropization	Non-neutral plasma physics, small size
----- POPS	----- Potential well formation Stability in pulsating trap	----- New plasma state, small size
Fast Igniter	Laser propagation and electron transport in dense target	Target design, advanced fuels Alternate compression
Cross-section enhancement	Practicality of muon catalysis, anti-proton catalysis, shape enhanced and spin polarized, pycnonuclear fusion	Reduced requirements for ignition and burn

Physics Issues/Opportunities in Emerging Concepts Connect with Mainline Approaches

Issue Concept	Convective Cells	Kinetic Effects	Flow Shear	Electric Fields	High β Physics	Helicity Current Drive/ Self-Organization
RFP					◆	●
Spheromak					◆	●
FRC	●	●	●		●	●
Ion Rings		●				
MTF	●	●	●		●	
Dipole	●		◆		●	
Centrifugal			●	◆	◆	
Mirror/GDT					◆	
Flow Pinch			●		●	
Electrostatic				●	●	
Fast Igniter		●		●	●	
Cross section						
Tokamak/ST		●	●	◆	◆	●
Stellarator		●				
IFE		●		●	●	

Physics Issues In Emerging Concepts

< Cross-cutting physics issues:

- + Convective cells – Particle/energy transfer mechanism in systems with no toroidal transform (FRC, Ion-ring, Dipole). Theoretically can transport particles without energy (advanced fuel advantage).
- + Kinetic (and other) modifications to MHD – Require modified macrostability model to understand stability of FRC, Ion-ring. Can benchmark complex models in simple, accessible systems.
- + Flow shear – Flow can be driven (Flow pinch, centrifuge) or may arise spontaneously (FRC). Important fusion science topic can be studied in small, simple system.
- + Electric field dominant – Systems with magnetized or unmagnetized electrons and electrostatically confined ions access new physics regimes related to nonneutral plasma confinement.
- + $\beta \gg 1$ physics – High-, and superhigh- β configurations challenge plasma physics models and connect to general convective dynamo and other unique physics.
- + Helicity current drive/self-organization – Essential feature of RFP, spheromak, FRC(?), MTF.

Unique Physics Examples from Emerging Concepts

< Field-Reversed Configuration

- No B_{toroidal} , $\beta \sim 1$ (aspect unity toroidal Z-pinch)
- Robustly stable for small R/ρ_i
- Ideal configuration for studying kinetic extensions to MHD
- Self-organized state, merging spheromaks with slightly unequal counter- helicities gives zero helicity FRC
- May have significant flow shear and associated flow stabilization
- Plans to use Rotating Magnetic Field current drive to sustain and increase flux
- Empirical, diffusive confinement scaling already sufficient for Magnetized Target Fusion target candidate ? gives high yield when compressed to high-density

Unique Physics Examples from Emerging Concepts

< Electrostatic

- Absolute nonneutral electron confinement system, weak B, large E
- Electron space charge confines minority ions absolutely
- Connection to IEC/SCIF neutron source, uses spherical focussing to get reaction rate
- Theoretical development of new plasma state for ions, nonsteady (oscillating) thermal equilibrium
- Q, mass power density can be very high with very low wall load
- Experiment (at CD level) < cm radius sphere
- Unique reactor extrapolation

< Fast Igniter

- Unique application of picosecond laser to IFE
- Compression without usual severe symmetry and pulse shaping requirements
- Hot spot ignition by fast electrons from picosecond laser pulse
- Requires successful laser/plasma interaction for clearing hole through corona
- Unique laser/matter interaction for intense pulse absorption, hot electron generation, transport

Mass. Modular Reactor Vision

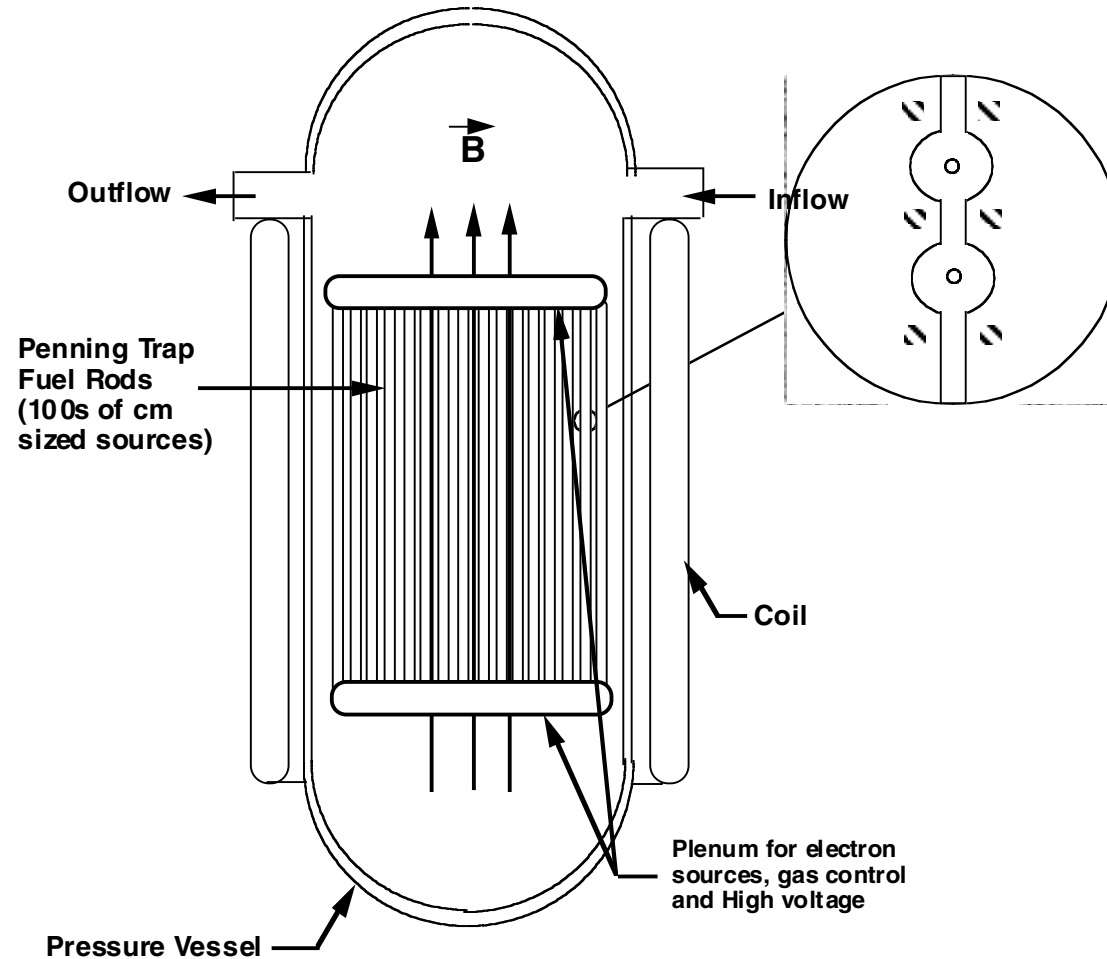

Transport of Ignition Pulse Energy Looks Promising

- Initial hole boring seen
- Laser absorption into plasma shown
- Efficient production of energetic electrons (~30%)
- Some indication of directed electron current
- Ignition after compression modeled

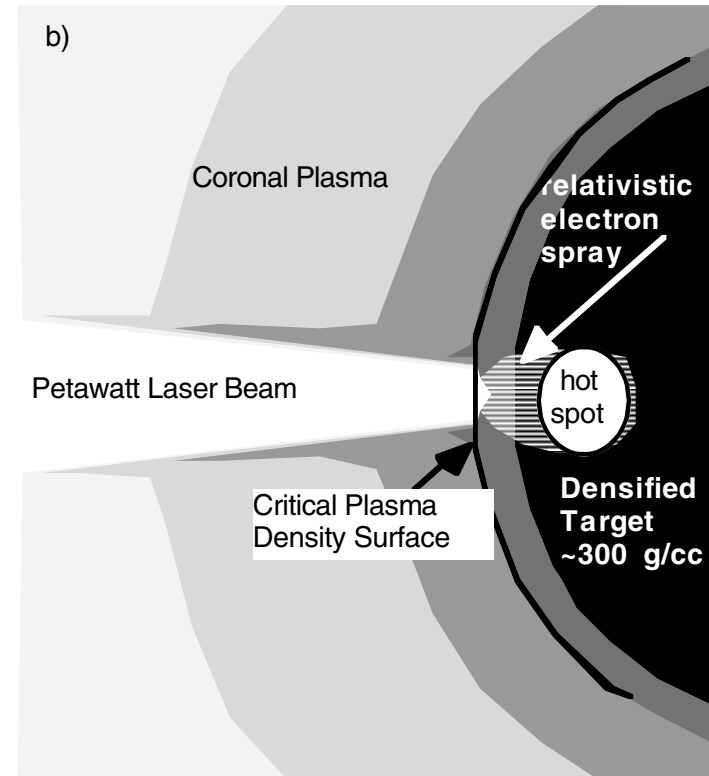

Thanks to Richard Stevens -- General Atomics

Reactor Issues In Emerging Concepts

CONCEPT	REACTOR ISSUES	REACTOR OPPORTUNITIES
RFP	Current drive, feedback	Smaller size/cost, high β & power density
Spheromak	Current drive, feedback	Smaller size/cost, no center post, pulsed or CW
FRC	Current drive, stabilization	$\beta = 1$, smallest size/cost MFE concept, natural divertor
Ion Rings ----- Colliding beam	Formation, ring energy loss, spread	High β , natural FRC 'anchor', small size
MTF	Driver & target design, standoff, component replacement	Low development \$ to reach thermonuclear plasma, many liner & target options
Levitated Dipole	Levitated ring technology, power density	High β , τ_E . No parallel current drive
Centrifugally confined plasmas	High V insulators Flow sustainment	High β . No parallel current drive
Mirror/GDT ($\lambda \ll L$) ----- Tandem ($\lambda \gg L$)	Large unit size	GDT (collisional mirror) low physics risk, linear geometry
Flow Pinch	End loss power. Electrode erosion	High β , low size/cost High power density

Reactor Issues In Emerging Concepts

CONCEPT	REACTOR ISSUES	OPPORTUNITIES
Electrostatic IEC ----- POPS	Massively-modular, POPS power, insulators, recirculating power	High mass power density, low wall load, alternate applications
Fast Igniter	Ignition laser energy, target design	High gain, low recirculating power
Cross-section enhancement	Power to create catalyst	Low $n \tau T$ needed of non-thermonuclear

Reactor Potential of Emerging Concepts

Concept	Motivation
RFP	Low external field; no disruptions
Spheromak, FRC	Simple geometry; small size; open axial divertor
MTF, Flow Pinch	Low development cost; compatible with liquid walls
Levitated Dipole, Centrifugally confined	High β , classical confinement; no current drive
Mirrors	Low physics risk; linear geometry
Electrostatic, IEC, POPS	Small unit size; low-cost development; high mass power density; alternate applications
Fast Igniter	High gain; low recirculating

Reactor Issues In Emerging Concepts

⟨ Generic issues:

- + $n \tau > n \tau_{\text{Lawson}}$ at reasonable size/cost
- + Increasingly detailed designs will determine:
 - Power density
 - Recirculating power
 - Availability

⟨ Non-toroidal concepts are good candidates for liquid walls and direct conversion enhancements

⟨ Advanced fuels may be possible for some high- β concepts

⟨ Reactor, system studies progress on a par with physics development

Metrics Required for Success & Advancement

	Qualitative Metrics (advancement requires a science-based prediction that the next-level metrics can be met)	Target Quantitative Metrics for MFE*	Target Budget (\$M/yr)
Concept Definition	<ul style="list-style-type: none"> < Defines a CE experiment that addresses uncertain physics or tech issues of the concept < At a minimum, theory indicates that the CE experiment will be grossly stable < A fusion application is defined 	$\tau > \tau_A$	0.3
Concept Exploration	<ul style="list-style-type: none"> < Obtains sufficient theoretical, computational, & experimental knowledge & understanding of the science to confidently describe the current CE experiment and predict the next PoP experiment < Gross stability is demonstrated < A competitive fusion reactor is supported by the physics & technology 	$T = 0.4 \text{ keV}$ $n\tau = 10^{17} \text{ s/m}^3$	3.0
Proof of Principle	<ul style="list-style-type: none"> < Establishes most of the experimental & theoretical physics bases and validity for fusion application < Can confidently describe and predict the performance extension experiment < An improved fusion reactor is supported by the physics & technology 	$T = 2 \text{ keV}$ $n\tau = 10^{19} \text{ s/m}^3$	15.0

* Non MFE concepts should target equivalent quantitative metrics

Emerging Concept Program Makeup

- ⟨ Three primary categories
 - **Concept Definition**
 - Concept Exploration
 - Proof-of-Principle

- ⟨ Presently Emerging Concepts are ~ 5% of program and should be increased significantly

- ⟨ Emerging Concepts should compete on an equal basis with mainline-related proposals

- ⟨ There should be continued separate funding of basic plasma science and education

At All Development Levels

- ⟨ Projects must have well-defined metrics for success and advancement to next level of development, and provide a science-based (experiment/theory/computation) prediction of success.
- ⟨ Projects must have met previous metrics for advancement.
- ⟨ Peer-reviewed, regular new opportunities for renewals or starts funded by termination or graduation of other projects.

Concept Definition

- ⟨ Proposals may have various levels of ‘fleshing out’
- ⟨ Should have basic ‘better’ reactor vision or new physics
- ⟨ Continuous evaluation – annual competition
- ⟨ Good theory development or experimental demonstration of configuration
- ⟨ 1-3 years, non-renewable
- ⟨ Must advance to Concept Exploration or be dropped
- ⟨ Target budget \$0.3 M/yr

Concept Exploration

- < Desirable to have larger community interest
- < Reactor vision may lack details, but should be attractive under assumption of physics success
- < Multiple experimental / theoretical efforts are highly desirable for each concept
- < Ongoing (3-4 year) major reviews
 - Should have demonstrable progress in either experiments, theory/computation, or *new* ideas
- < Target budget \$3 M/yr

Proof-of-Principle

- ⟨ EC's compete on an equal basis with other PoP
- ⟨ Offer cost advantage with reasonable, science-based physics assumptions
- ⟨ Provide a real opportunity to establish new, scalable fusion physics and technology regimes
- ⟨ Target budget \$15 M/yr

Examples of EC Applications--Present, Near-term, and Envisioned

- ----- present applications -----
- Fusion neutron activation analysis, non-destructive testing and inspection
- Plasma and technology, e.g, plasma thrusters, plasma processing, chemical waste processing
- Scientific studies, e.g. solar and magnetosphere physics
- ----- near term applications under development-----
- Neutron tomography
- Medical isotopes & radiation therapy
- Neutron source for driven fission reactors (improved safety), materials testing, nuclear waste transmutation
- -----future applications under study-----
- High- power fusion space propulsion units
- Small electrical fusion power units with advanced fuels and direct conversion

Some major markets exist, e.g medical isotopes

- World demand for radioisotopes = 100 \$M in 94 (\$59M, medical; \$41M indust. & research.)
- Mo-99, Tc-99m used in over 10^7 procedures annually.
- 40% hospitalized patients undergo nuclear medicine; increasing aging population will expand use.
- Small fusion n/p source appears competitive for production vs. present centralized accelerators/reactors

Summary of EC Working Group - I

⟨ **Emerging Concepts enrich and strengthen the fusion program by providing diverse:**

- Unique opportunities for fusion science physics and technology development
- Possibilities of much improved to breakthrough fusion products
- Great potential for non-energy applications of fusion science (already commercialized fusion source)
- Required for healthy multi-decade fusion program to feed higher stages of development
- Support mainline research through transfer of plasma science
- Progress in fusion metrics ($nT\tau_E$, sustainment, mass power density, ...) at reasonable cost

Summary of EC Working Group - II

- < **Fusion needs a continuous, peer-reviewed, emerging concept program, supported **as a matter of policy** at some percentage of the national budget.**
 - **Incubator for fledgling, new ideas**
 - Summer institute
 - Scientific empowerment of all researchers to encourage broad and open study
 - Apply theoretical and computational resources
 - Involvement of academia and quality new students
 - **Periodic (**annual!**), significant open competition for new starts and renewals**
 - **Well-defined metrics and periodic peer reviews for ongoing Concept- Exploration projects**
 - **Well-defined metrics and clear mechanism for “graduation” to the Proof-of-Principle level**