



Standardization of Numerical and Experimental Methods for Crashworthiness Energy Absorption of Composite Materials

Paolo Feraboli

Aeronautics and Astronautics

University of Washington

Presented at the JAMS Annual Meeting

June 17-19, 2008

At the Future of Flight - Everett, WA

Outline

Motivation

- *Complete lack of standards and accepted practices in testing and analysis of composites under crash conditions*

Benefits to Aviation

- *Streamline certification process*
- *Increase confidence in analysis methods and therefore level of safety*

Objective

- *Develop experimental and numerical best practices, design guidelines, and test standards*



Outline

Approach

- **Experimental p. 5-24**
 - *Collect and evaluate current test practices*
 - *Develop standard test methods*
- **Numerical p. 25-41**
 - *Collect and evaluate current modeling practices*
 - *Develop improved modeling techniques*
- **Conclusions and Acknowledgments p. 42-43**



Outline

Principal Investigator

- *Dr. Paolo Feraboli*

FAA Technical Monitor

- *Allan Abramowitz*
- *Curt Davies*

Other FAA Personnel Involved

- *Dr. Larry Ilcewicz*

Industry Participation

- *Dr. Mostafa Rassaian (Boeing Phantom Works)*
- *Dr. Xinran Xiao (General Motors)*
- *CMH-17 Crashworthiness Working Group*
- *Kyle Indermuehle (SIMULIA)*

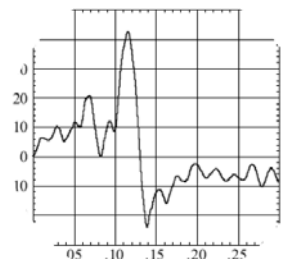

Crashworthiness

Experimental Standardization

- *No existing test standard to determine SEA*
- *No way to screen material systems/ forms/ lay-ups*
- *Material suppliers, OEM's and regulators need to have common ground*
- *Goal is to develop test standard and design guidelines*

Two current directions in research:

- *Flat specimen with support fixture*
 - *NASA fixture*
 - *Engenuity fixture*
 - *Modified NASA fixture (UW)*

- *Self-supporting “sinusoidal” specimen*
 - *Semicircular specimen (DLR)*
 - *Sinusoidal specimen (Hanagud et al.)*
 - *Corrugated specimen (UW)*

NASA fixture:

- *Notch and steeple triggers*
- *Knife-edge supports suppress delamination and favors stable crushing*
- *Also prevent natural deformation at the crush front.*
- *Tearing at the edges \ Limited to one specimen thickness*

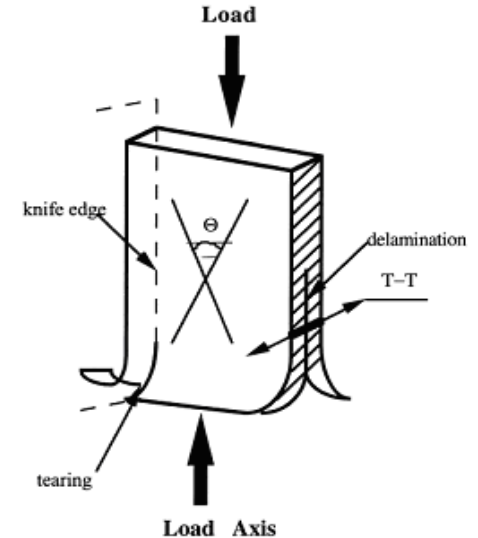
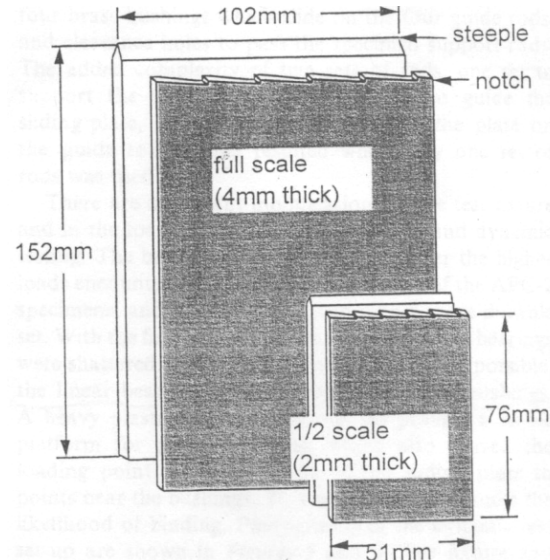
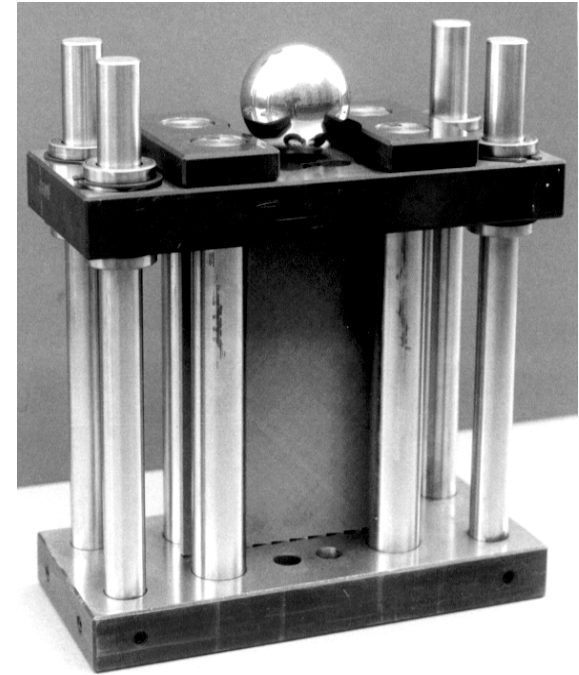

Engenuity Fixture:

- *Saw-tooth trigger*
- *Flat Delrin supports*
- *Greater freedom to crush freely thanks to spacer height*
- *Not much additional detail*
- *So-called spacer height affects SEA measure, thus calibration necessary.*
- *“Good” vs. “Bad” materials*

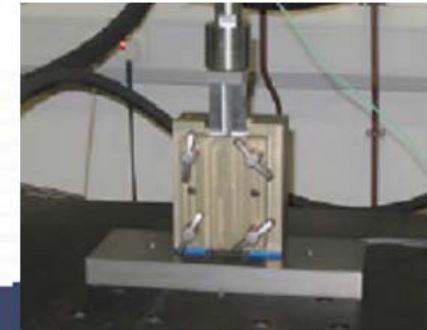
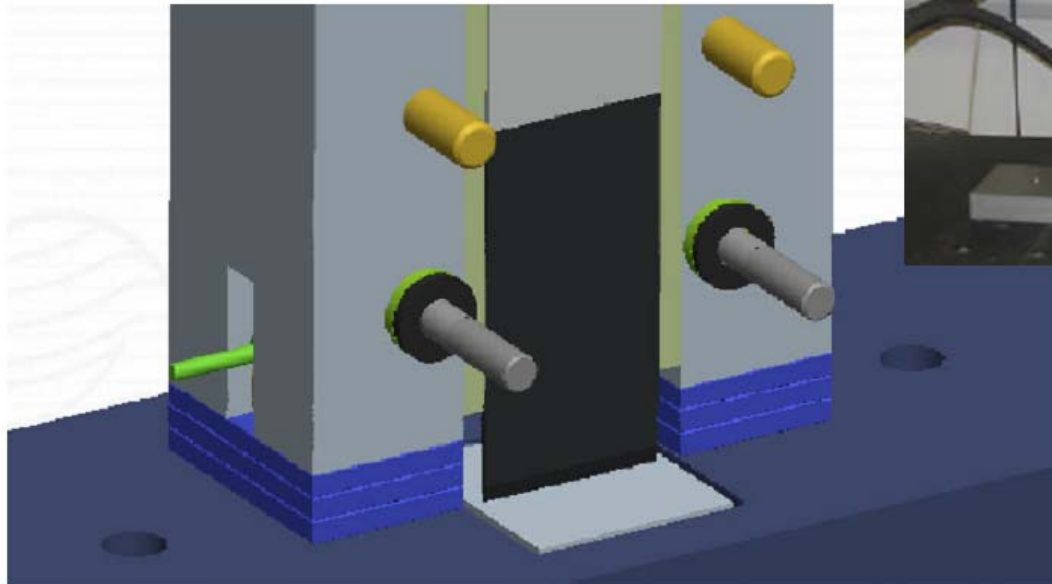

Modified NASA Fixture (UW)

- *Based on NASA and Engenuity fixtures*
- *Knife-edge support similar to NASA.*
- *Variable unsupported height similar to Engenuity*
- *Can accommodate variable thickness specimens*
- *Three triggers: “steeple” (NASA), saw-tooth (Engenuity), and 45 degree chamfer*

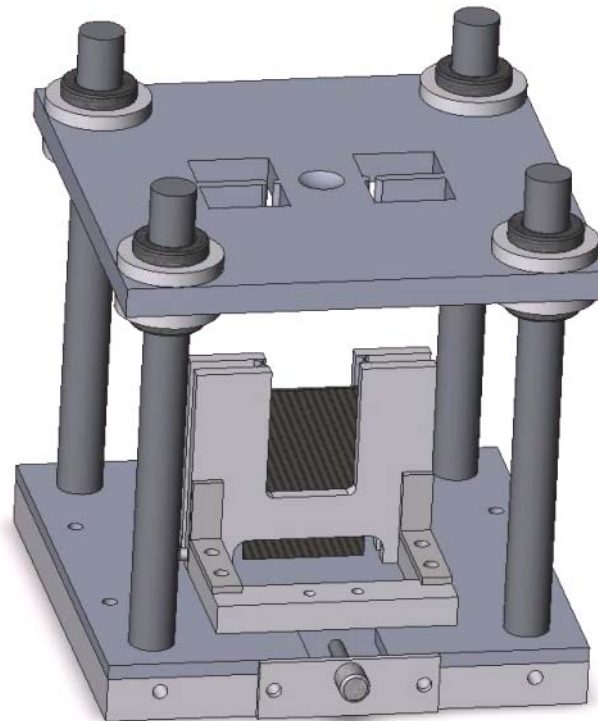

Modified NASA Fixture (UW)

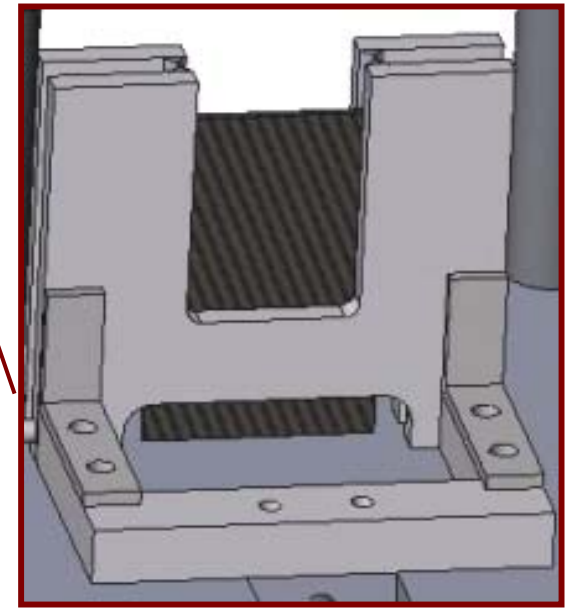
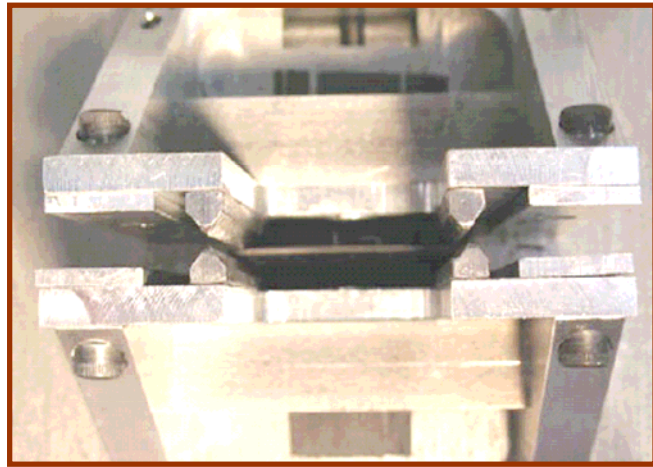
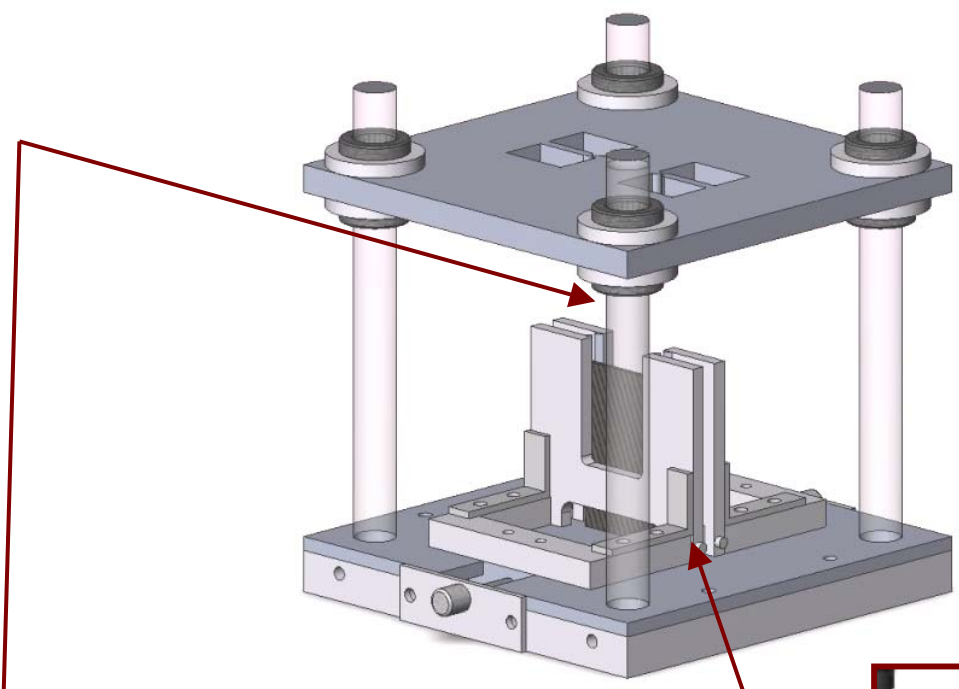

Modified NASA Fixture (UW)

- Failure modes (and hence SEA) vary based on material form/ type/ properties

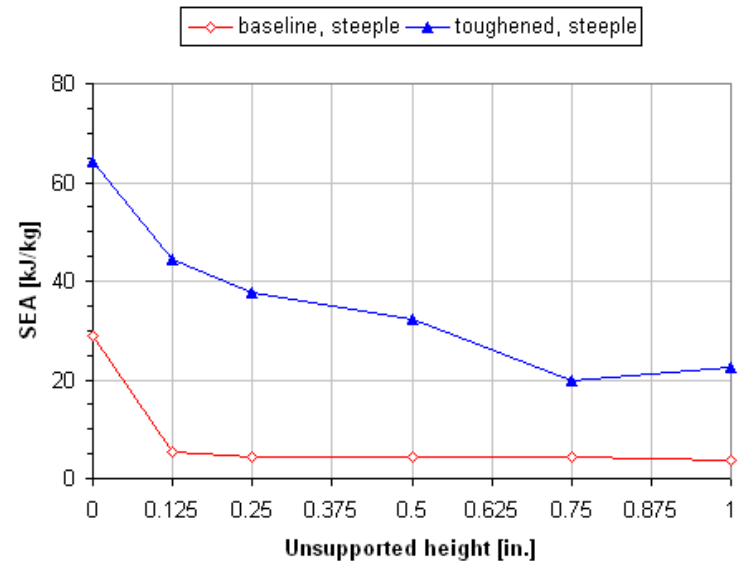
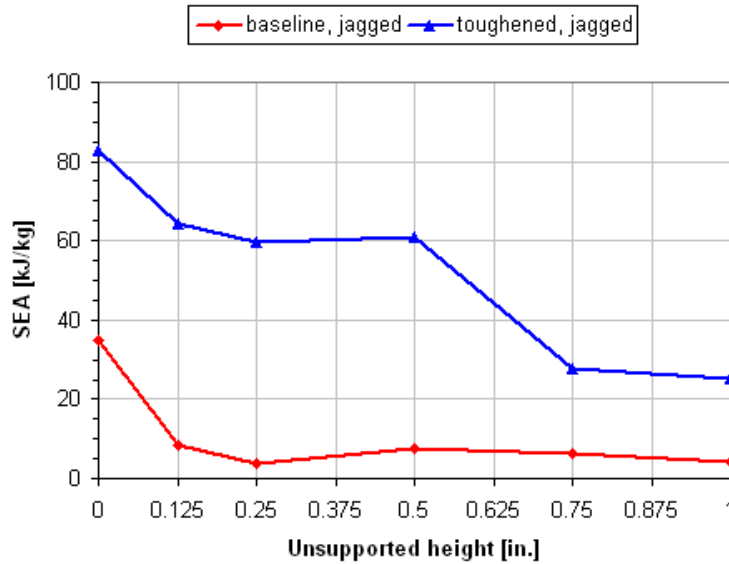

Modified NASA Fixture (UW)

- Focus on a toughened tape material using saw-tooth trigger

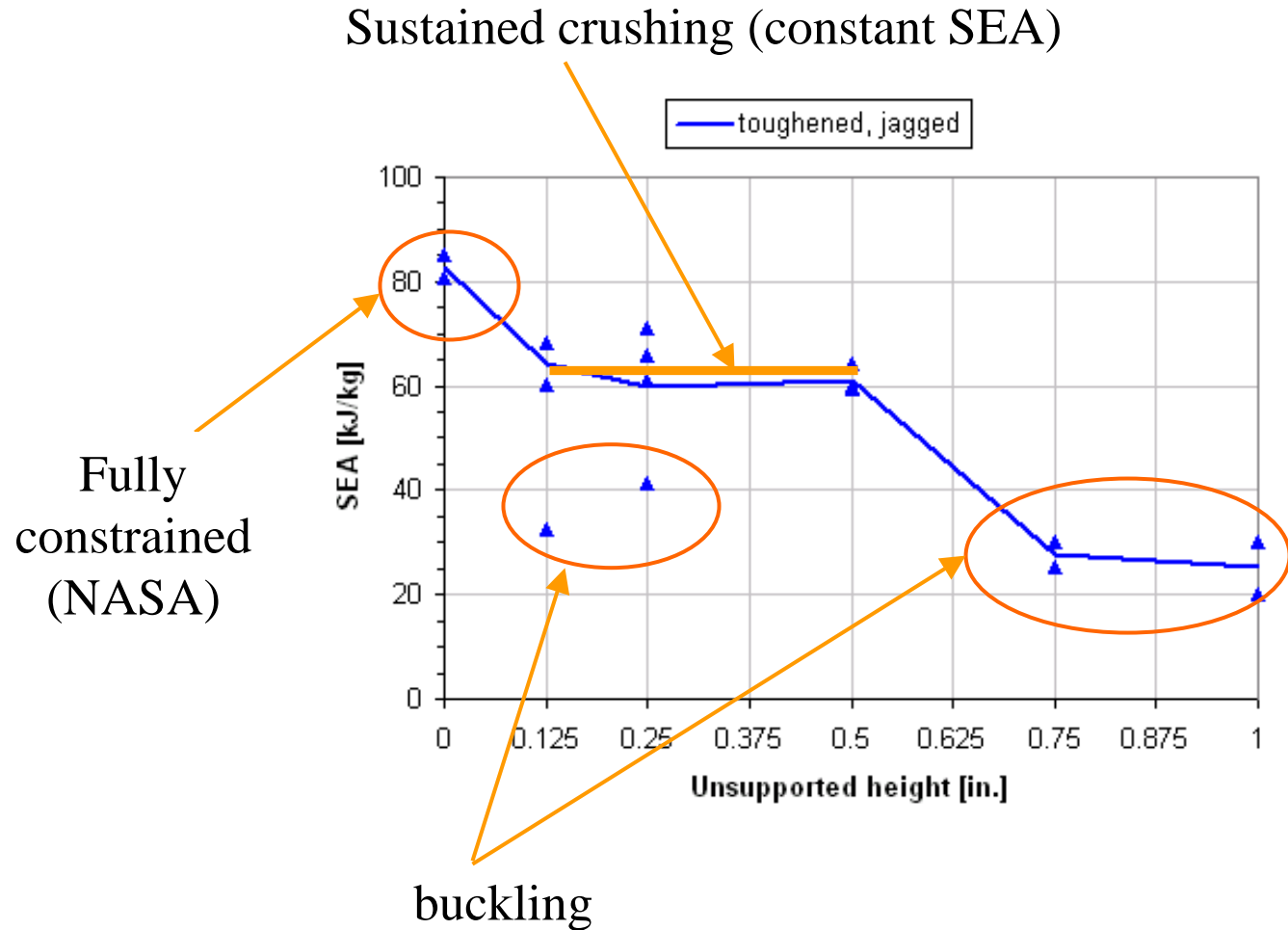

Modified NASA Fixture (UW)

Failure mechanism and morphology (and hence SEA) vary based on material form/ type/ properties

- *Baseline does not crush – only splits among the midplane*

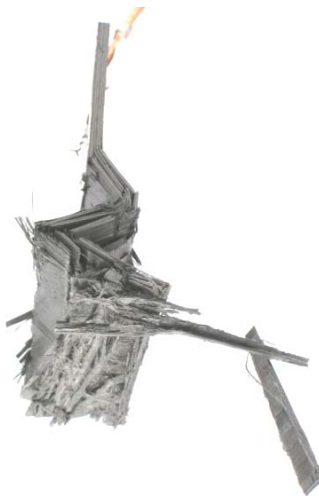
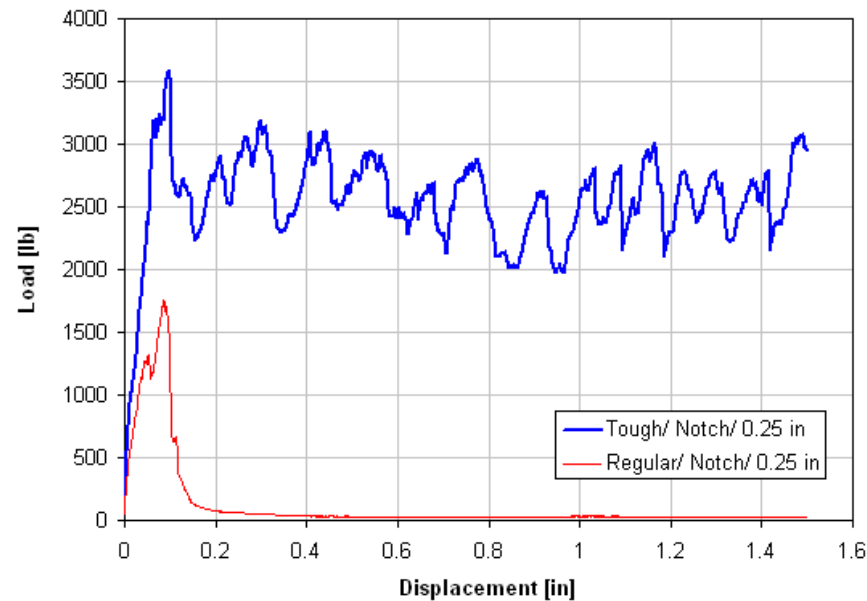

Modified NASA Fixture (UW)

Failure modes (and hence SEA) vary based on type of crush initiator

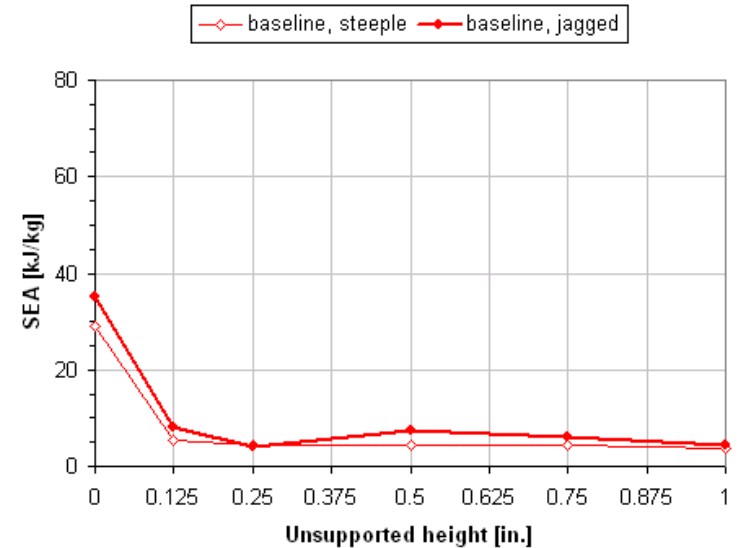
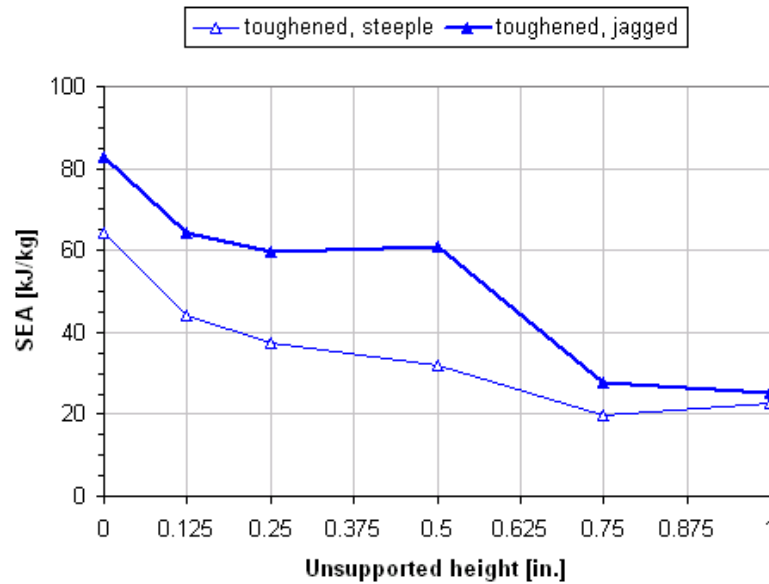

Semicircular specimen:

- *Self-stabilizing but requires bonding to a machined aluminum base*
- *Tendency to twist due to eccentricity*



Height \approx 67 mm



Isometric View

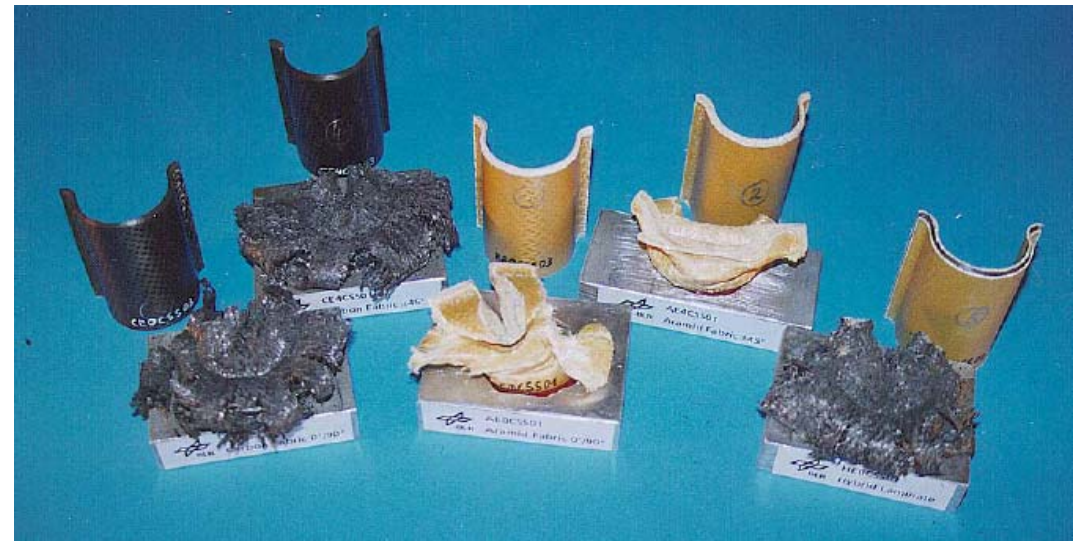
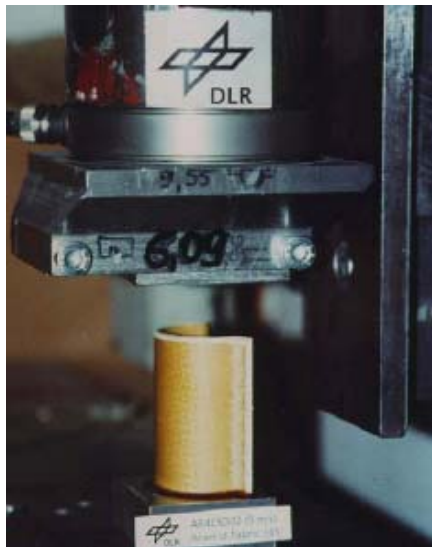
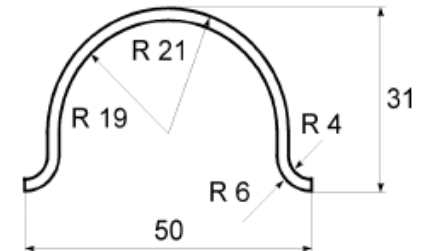

Sinusoidal specimen

- Hanagud, S., Craig, I., Sriram, P., Zhou, W., "Energy Absorption Behaviour of Graphite Epoxy Composite Sine Webs", *Journal of Composite Materials*, 23/5, 1989, pp. 448-459

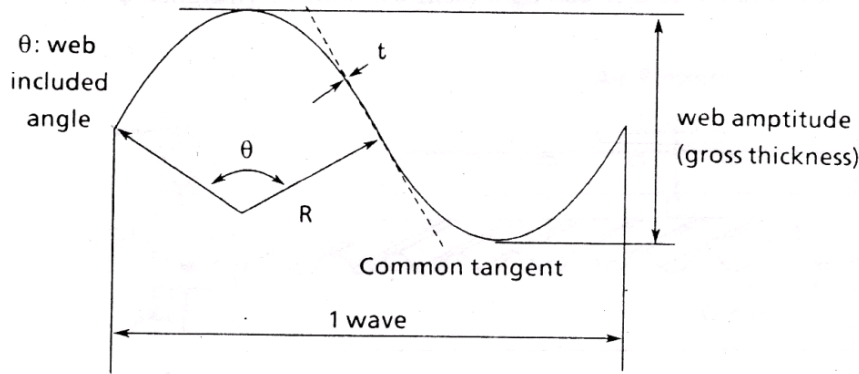

Figure 4. Sine wave terminology.

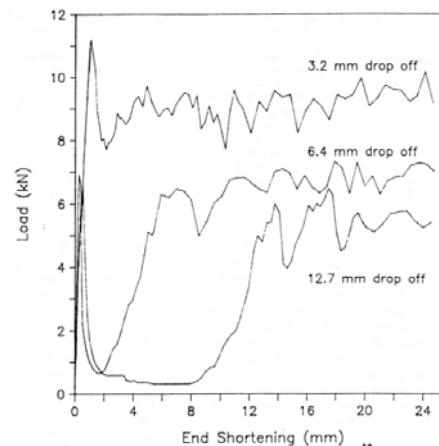

Figure 7. Effect of initiator size.

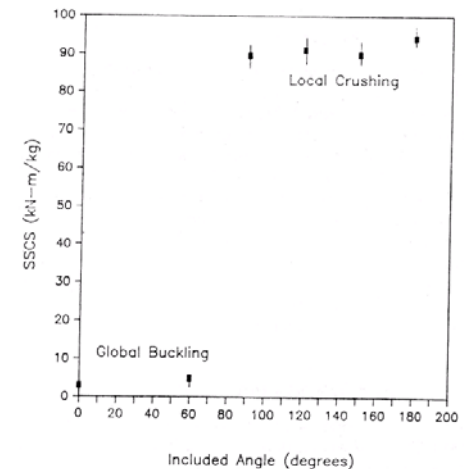

Figure 10. Included angle (gross thickness) effect.

UW work on corrugated specimen:

- *Semicircular specimen*
- *Center of twist closer to median than DLR tube segment*
- *Less need to constrain or to lose specimen due to slippage*
- *Self-stabilizing: no test fixture necessary*



Half Circle Specimen
all dimensions are in inches

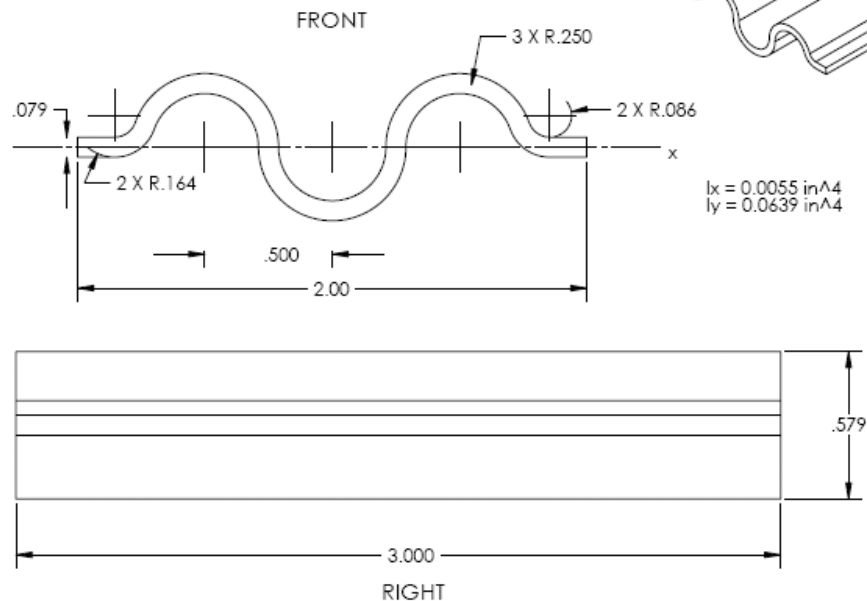

UW work on corrugated specimen:

- 3 corrugations: 1 semicircular and 2 sinusoidal



Half Circle Specimen
all dimensions are in inches

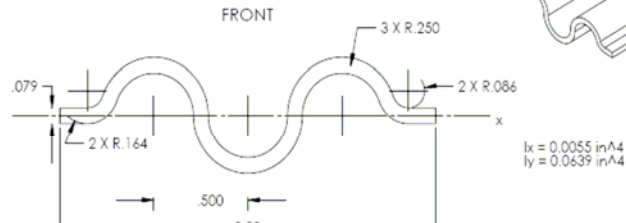

Low Sine Specimen
all dimensions are in inches

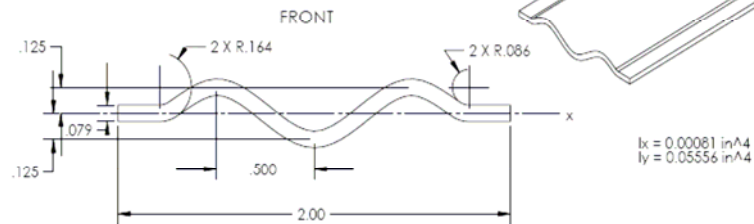

Deep Sine Specimen
all dimensions are in inches

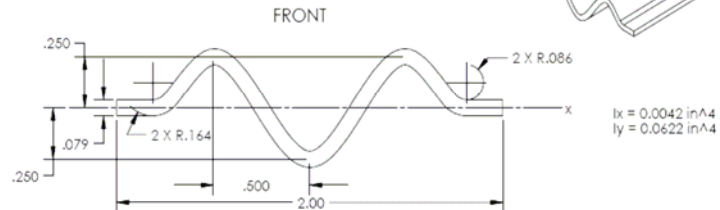

UW work on corrugated specimen:

- *Stable crushing always achieved*

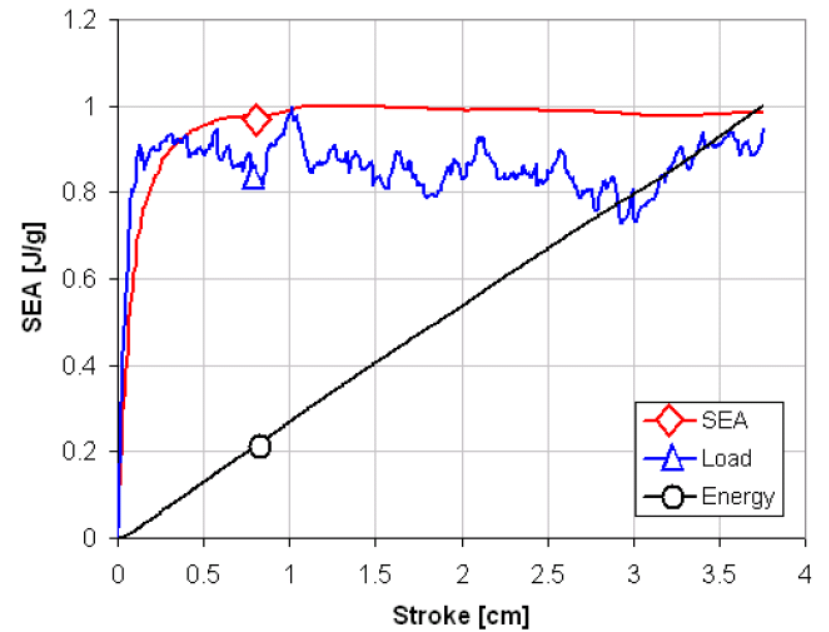

Corrugated Specimens:

- *45 degree chamfer works well*



Corrugated Specimens:

- Compare 3 corrugated specimens to flat plates

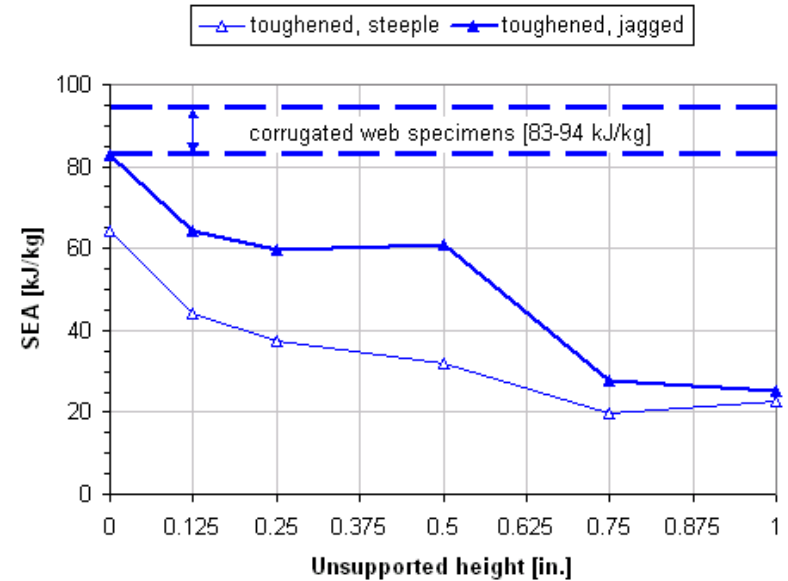
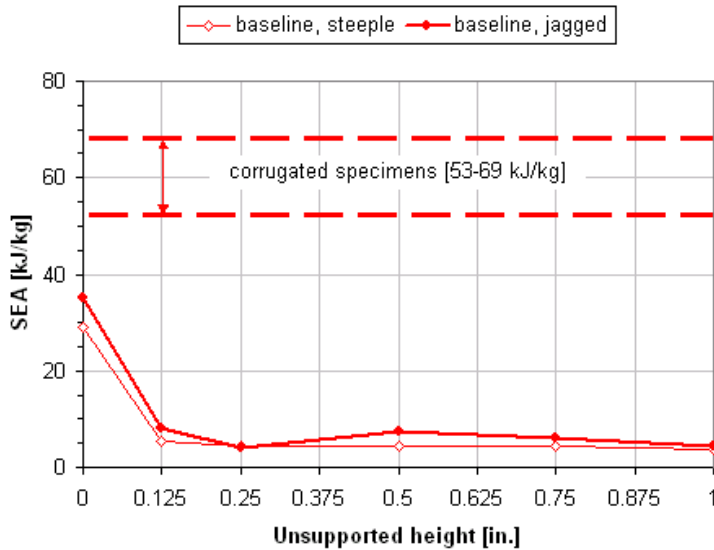

Robustness of corrugated specimen

Material systems tested

- *T700/ 2510 UD carbon/ epoxy (Torayca)*
- *T800/ 3900-2 UD carbon epoxy (Torayca)*
- *CSM glass/ epoxy (General Motors)*
- *T700/ 2510 Plain Weave carbon/epoxy (Torayca)*
- *AS4/ 8552 UD carbon/ epoxy (Hexcel)*

Range of parameters investigated

- *Toughened and untoughened epoxy*
- *Carbon and glass fibers*
- *Tape, woven, and random*
- *Prepregs and RTM*
- *Several lay-ups*
- *Rates: 0.05 in/min, 0.5 in/ min, 60 in/min (1 in/sec), 4740 in/min (79 in/sec)*

Status to date on Experimental Standardization

- *Flat plate specimen yields measures of energy absorption that do not compare well with other tests*
- *Fixture poses several questions*
 - *Unknown boundary condition effects*
 - *Variable unsupported height effects*
 - *Difficulties for dynamic testing*
 - *Not all the relevant failure mechanisms may be captured*
- *Corrugated specimen provides self-supporting, simple, repeatable configuration*
- *Need to better understand the dependence of measured energy absorption on implicit and explicit characteristics of the test*

Future work on Experimental Standardization

Corrugated specimen

- Assessed influence of some key specimen parameters (corrugation shape, scaling,...)
- Need to perform systematic comparison of:
 - Flat plate specimens (modified fixture)
 - Corrugated web specimens
 - C-channel sections
 - Square tubes

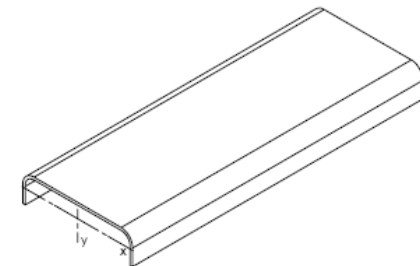
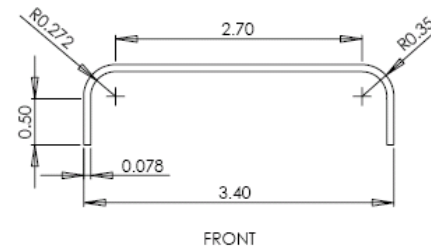

$I_x = 0.020579 \text{ in}^4$
 $I_y = 0.53755 \text{ in}^4$

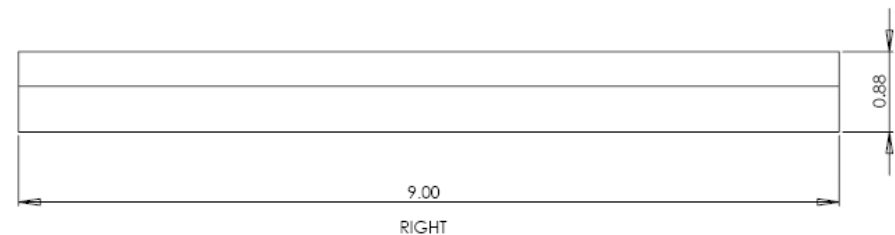

Crashworthiness

- **Numerical standardization**
 - *Current FE modeling strategies are not predictive*
 - *Round Robin initiated involving major FE explicit dynamic codes to characterize material models and modeling strategies*
 - *Goal is to develop guidelines for best analysis practices*



Numerical Standardization

- *Non-linear, dynamic simulation requires explicit FEA codes*
- *Common commercial codes used in this field are:*
 - *LS-DYNA (LSTC)*
 - *ABAQUS Explicit (SIMULIA)*
 - *PAM-CRASH (ESI)*
 - *RADIOSS (ALTAIR)*
 - *NASTRAN-DYTRAN (MSC)*
- *Each code is unique for:*
 - *Material models*
 - *Failure criteria implementation*
 - *Strength and stiffness degradation strategies*
 - *Other code parameters*
 - *contact definition*
 - *damping, time steps, etc...*

CMH-17 Numerical round-robin

- *LSTC LS-DYNA:*
 - *Xinran Xiao (MAT58) – General Motors*
 - *Mostafa Rassaian (MAT54) – Boeing Phantom Works*
 - *Rich Foedinger (MAT162) – MSC Corp.*
 - *Paolo Feraboli (MAT54) – Univ. Washington*
- *ABAQUS EXPLICIT:*
 - *Kyle Indermuehle (VUMAT fabric) – Simulia*
 - *Graham Barnes (C-zone) – Engenuity*
 - *Paolo Feraboli (VUMAT fabric) – Univ. Washington*
- *ALTAIR RADIOSS:*
 - *Jean-Baptiste Mouillet – Altair*
 - *Ari Caliskan – Ford*
- *ESI PAM-CRASH:*
 - *Anthony Pickett – ESI Germany/ Stuttgart Univ.*
 - *Alastair Johnson – DLR*

CMH-17 Numerical round-robin

- *Round robin initiated to evaluate the effectiveness and robustness of equivalent numerical models using a common, predefined target structure.*
- *First round: Corrugated specimen*
- *Second round: C-channel*
- **Common material:** *T700/2510 carbon/epoxy TORAYCA plain weave fabric certified during the AGATE program.*
- **Common specimen geometry and initiator**
- **Common laminate lay-up:** $[(0/90)]_{3s}$
- **Deliverable:** *For every submission*
 - *Compile simulation datasheet*
 - *Exhibit force-deflection curve and SEA curve*
 - *Exhibit animation/ sequential figures of failure morphology*

Numerical Standardization

- Composite are treated as orthotropic linear elastic materials within a failure surface, which depends on the failure criterion adopted.
- Beyond failure, elastic properties are degraded according to strength degradation laws:
 - Progressive failure models: e.g. LS-DYNA MAT54
 - Damage Mechanics models: e.g. LS-DYNA MAT58, ABAQUS Explicit VUMAT Fabric
 - Purely empirical models: ABAQUS C-Zone

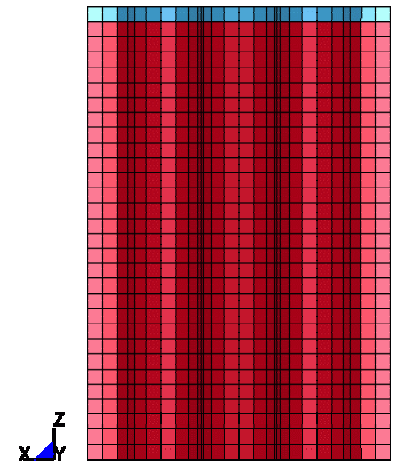
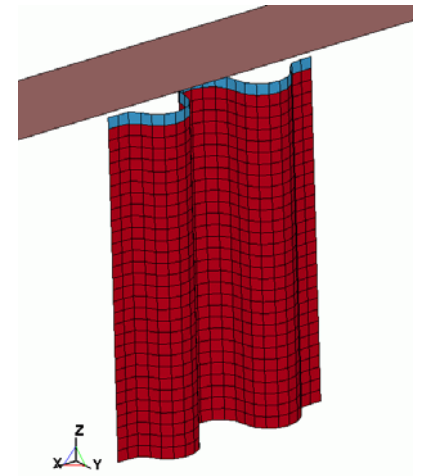

MAT54

- Material failure modeled using Chang/Chang criterion.
- Each time step, plies of the MAT54 (composite) elements are checked and modified using “progressive damage”. Once all plies have failed element is deleted
- Need only traditional strength values
- Need 10 additional parameters for failure

Time failure: TFAIL

Reduction at crush front: SOFT

After matrix compressive failure: XT=XT*FBRT, XC=YC*YCFAC (54)

MAT54: maximum strain for layer removal

DFAILM, DFILS, DFAILT, DFAILC, EFS

Fiber tensile	$e_f^2 = \left(\frac{\sigma_{11}}{X_T}\right)^2 + \beta\left(\frac{\sigma_{12}}{S_c}\right) - 1 > 0, E_1 = E_2 = G_{12} = \nu_{21} = \nu_{12} = 0$
Fiber compression	$e_f^2 = \left(\frac{\sigma_{11}}{X_c}\right)^2 - 1 > 0, E_1 = \nu_{21} = \nu_{12} = 0$
MAT54	Chang matrix failure
Matrix tensile	$e_m^2 = \left(\frac{\sigma_{22}}{Y_T}\right)^2 + \left(\frac{\sigma_{12}}{S_c}\right) - 1 > 0, E_2 = G_{12} = \nu_{21} = 0$
Matrix compression	$e_d^2 = \left(\frac{\sigma_{22}}{2S_c}\right)^2 + \left[\left(\frac{Y_c}{2S_c}\right)^2 - 1\right]\frac{\sigma_{22}}{Y_c} + \left(\frac{\sigma_{12}}{S_c}\right)^2 - 1 > 0, E_2 = G_{12} = \nu_{21} = \nu_{12} = 0, X_c = 2Y_c$
MAT55	Tsai-Wu criterion for matrix failure
	$e_{md}^2 = \left(\frac{\sigma_{22}}{Y_T Y_c}\right)^2 + \left(\frac{\sigma_{12}}{S_c}\right)^2 + \frac{(Y_c - Y_T)\sigma_{22}}{Y_c Y_T} - 1 > 0$

MAT54

- *Maximum failure strain in fiber tension, fiber compression, transverse tension or compression, and maximum shear strain can also be specified.*
- *If DFAILT is greater than zero, ply failure occurs based on DFAILT or DFAILC rather than the Chang-Chang criteria.*

Example Stress-Strain Curve

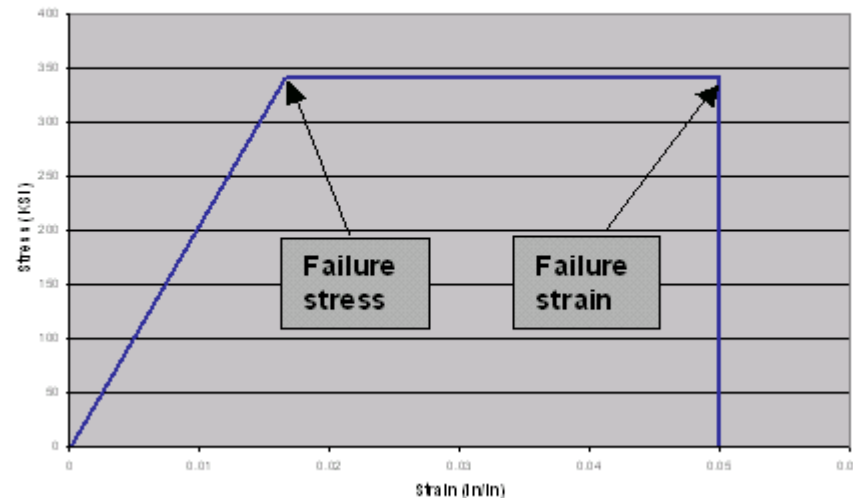

MAT54

- *Sawtooth pattern due to incremental failure of rows of elements – 600 Hz SAE filter used*
- *Cumulative simulation crush energy, area under load curve, matches test*
- *Elastic slope of simulation matches test prior to crush.*
- *The finite size of crush initiator elements effectively acts to shift filtered curve.*
- *Cannot currently simulate fracture, only crushing against rigid wall - delamination is not explicitly modeled*
- *Sawtooth force-displacement pattern may influence acceleration response at floor level*

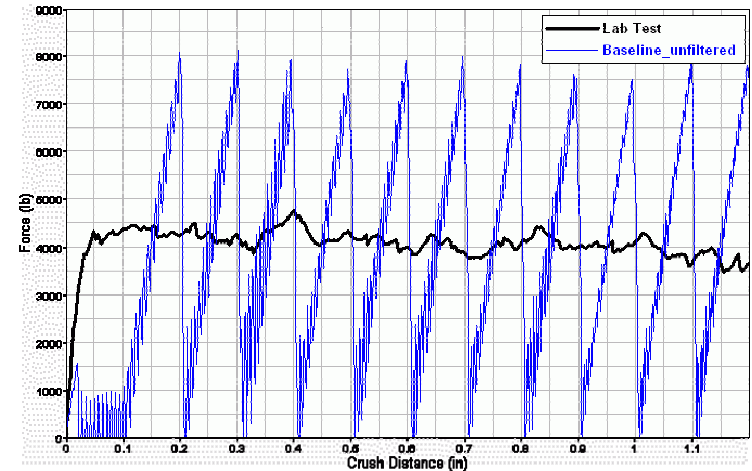

Test vs. Unfiltered Simulation

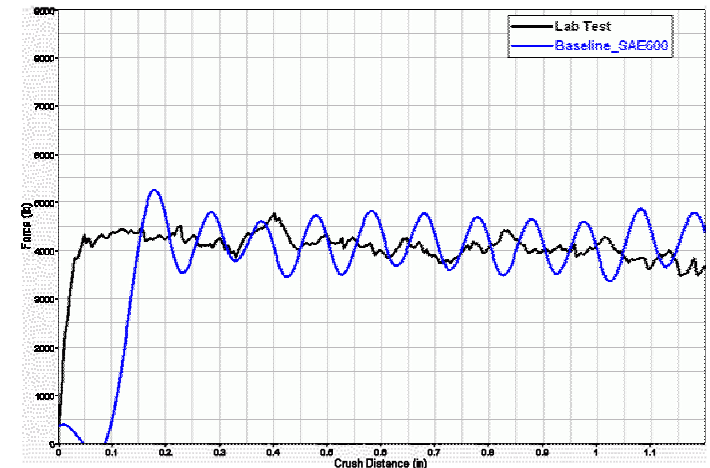

Test vs. Filtered Simulation (600Hz)



- *LS-Dyna SOFT parameters investigated: 0.4, 0.6, 0.8*
- *Average load changes, but initial slope and time unchanged*
- *Decreasing the height of the trigger row elements shortens the period of initial zero load but the initial slope is unchanged.*

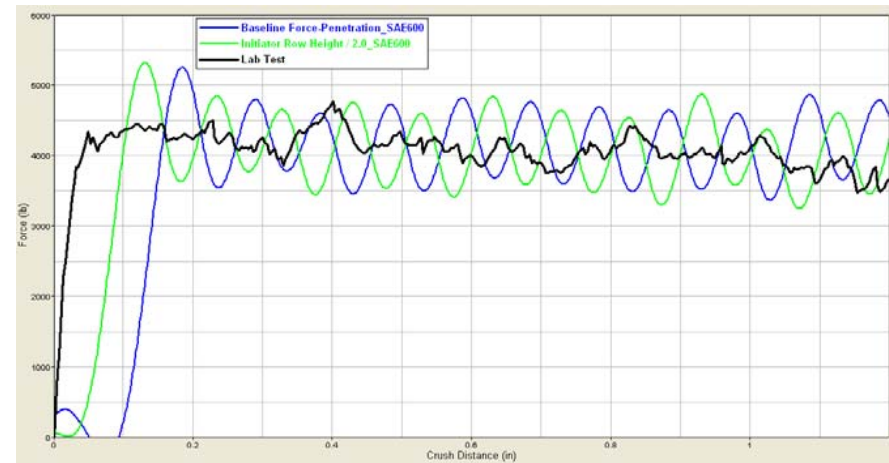
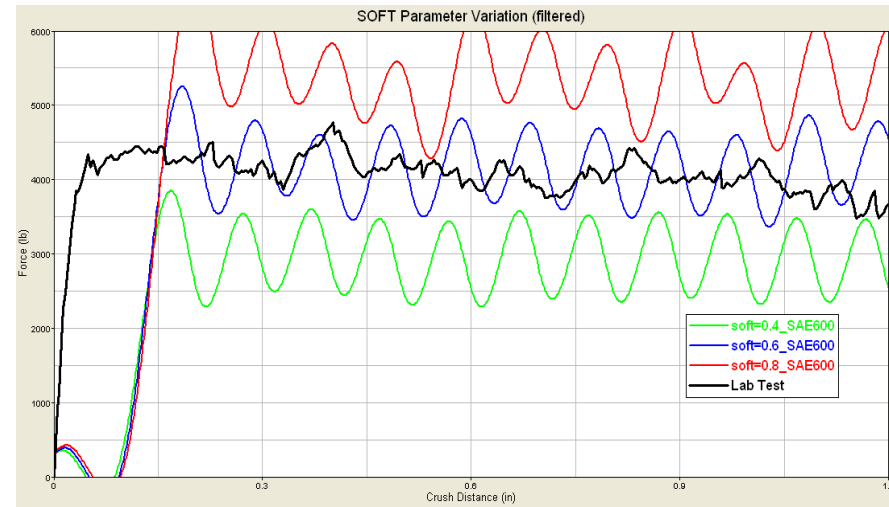

ABAQUS Explicit VUMAT Fabric

- CDM describe the collective influence of damage through the use of internal damage variables
- Damage variables cannot be measured directly: need to relate microstructure deterioration to macroscopic response
- CDM phenomenological models treat various damage mechanisms in a smeared fashion.

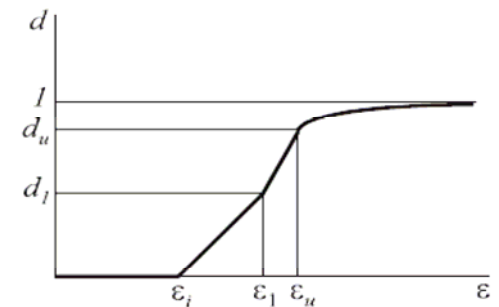
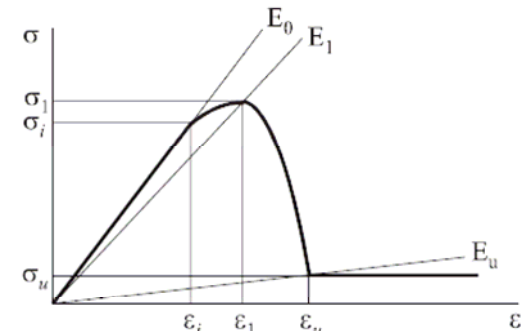
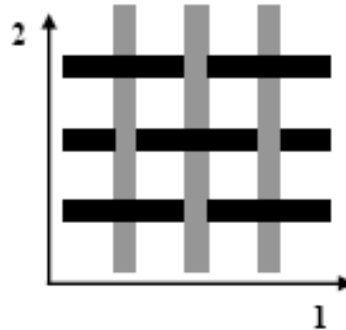

VUMAT Fabric

The damage variables d_1 and d_2 are associated with fiber fracture along the 1 and 2 directions respectively, whereas d_{12} is related to matrix micro-cracking due to shear deformation. The model differentiates between tensile and compressive fiber failure modes by activating the corresponding damage variable depending on the stress state in the fiber directions. Thus:

$$d_1 = d_{1+} \frac{\langle \sigma_{11} \rangle}{|\sigma_{11}|} + d_{1-} \frac{\langle -\sigma_{11} \rangle}{|\sigma_{11}|}; \quad d_2 = d_{2+} \frac{\langle \sigma_{22} \rangle}{|\sigma_{22}|} + d_{2-} \frac{\langle -\sigma_{22} \rangle}{|\sigma_{22}|}$$

$$\begin{pmatrix} \varepsilon_{11} \\ \varepsilon_{22} \\ \varepsilon_{12}^{el} \end{pmatrix} = \begin{pmatrix} \frac{1}{(1-d_1)E_1} & \frac{-\nu_{12}}{E_1} & 0 \\ \frac{-\nu_{21}}{E_2} & \frac{1}{(1-d_2)E_2} & 0 \\ 0 & 0 & \frac{1}{(1-d_{12})2G_{12}} \end{pmatrix} \begin{pmatrix} \sigma_{11} \\ \sigma_{22} \\ \sigma_{12} \end{pmatrix}$$

The VUMAT provides an option to delete elements when any one tensile/compressive damage variable along the fiber directions reaches a maximum specified value, $d_\alpha = d_{\max}$, or when the plastic strain due to shear deformation reaches a maximum specified value, $\bar{\varepsilon}^{pl} = \bar{\varepsilon}_{\max}^{pl}$.

VUMAT Fabric

- *Fiber response calibrated using in-plane fracture tests*

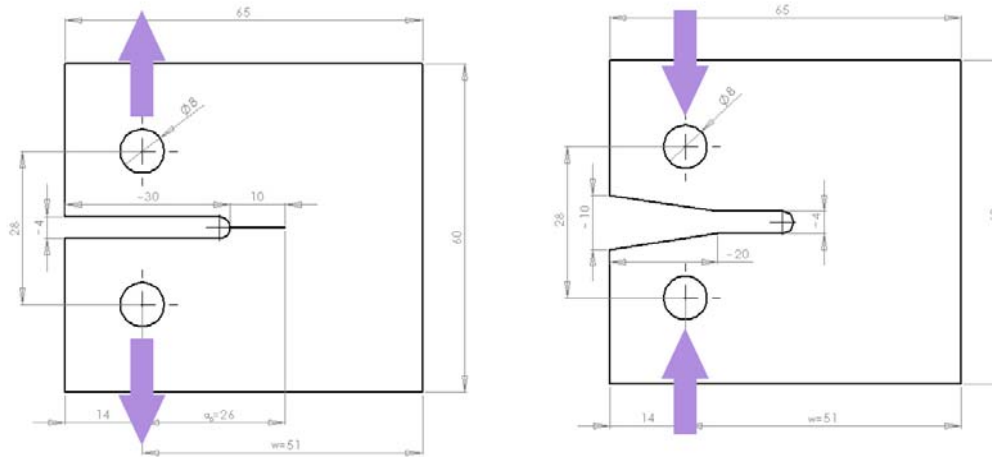

- *Matrix response calibrated on cyclic tension test on +/-45 laminate*

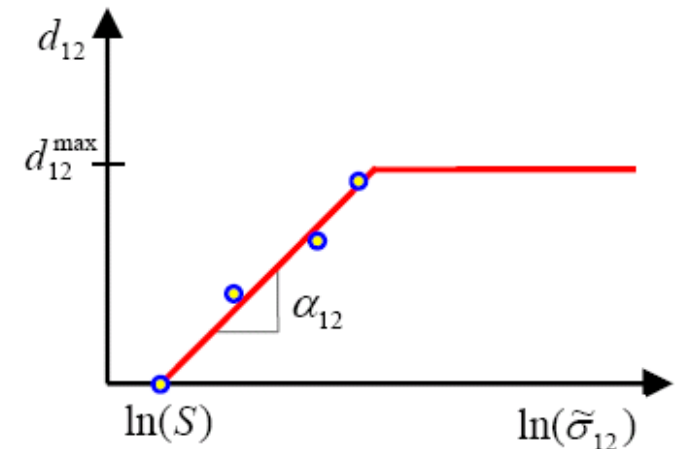
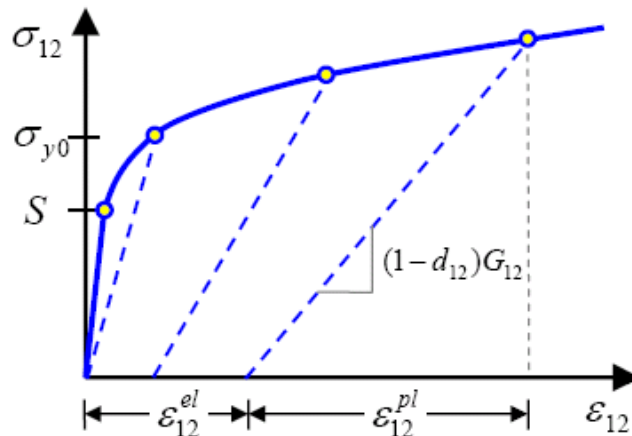

VUMAT Fabric

- *Need additional input parameters*
- *Need to determine empirically several damage parameters that are code-specific (same as MAT58)*



Material Properties	Testing (ASTM)
* Shear response	Monotonic and cyclic <u>uniaxial</u> loading of single ply with fibers oriented at $\pm 45^\circ$ of loading direction to calibrate matrix plasticity and damage evolution in shear
Compression	Stress-strain curve for single ply
Tension	Stress-strain curve for single ply
* G_{1+} (G_{2+})	Mode I fracture toughness for tensile loading of single ply along fiber 1 direction. Also along fiber 2 direction if unbalanced fabric. (There is no standard test method to measure this property. A procedure to measure this value was proposed by <u>Pinho</u> [1])
* G_{1-} (G_{2-})	The fracture toughness for longitudinal compression loading, if possible. (There is no standard test method to measure this property. A procedure to measure this value was proposed by <u>Pinho</u> [1])

***These tests are specific to this model/ code**

VUMAT fabric

- S4R element
- Section: shell, composite
- 2 sections: trigger and C0902s
- Material: carbon fabric

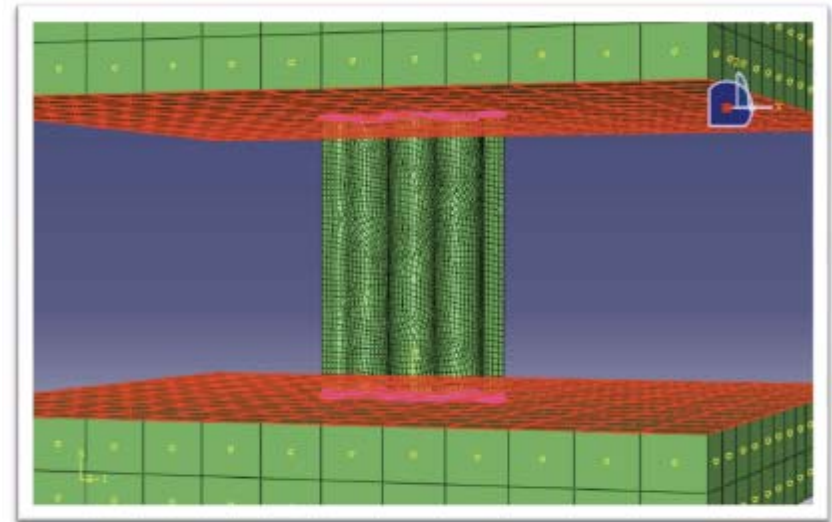

- = C0903s
- = trigger

Side view of the hc_specimen

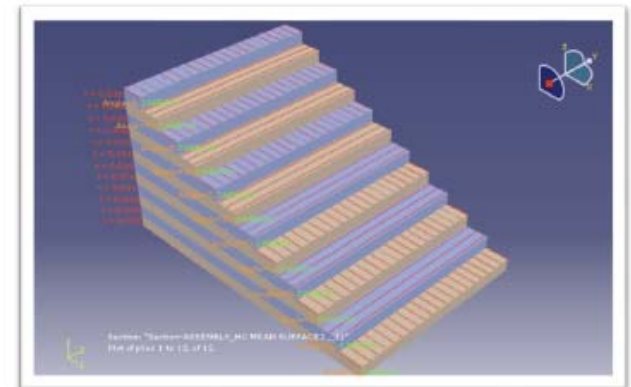

C0903s layup

VUMAT fabric

- Job terminates due to excessive deformation

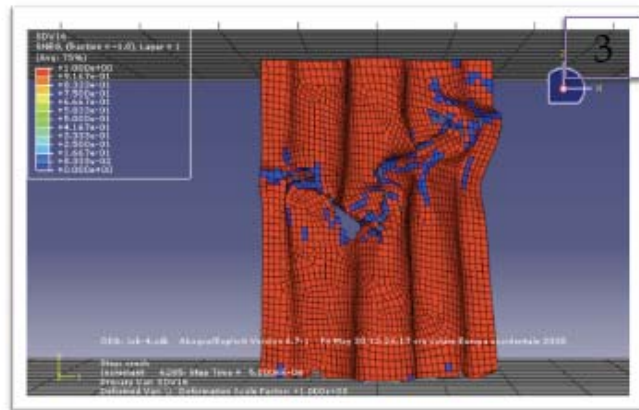
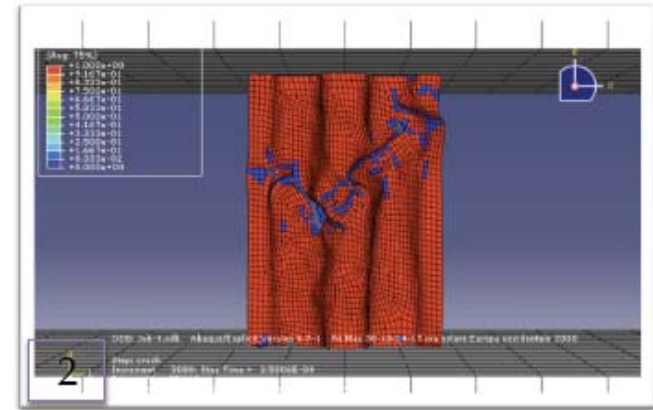
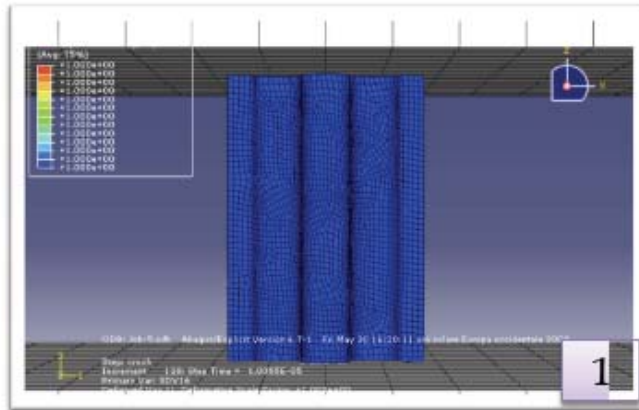

- 1st frame = all material point status are active
- 25th frame = blue elements are material points failed
- 51st frame (last one before job killed) = more material points failed and elements deleted due to buckling in a random section

Status to date on Numerical Standardization

- *Direction and help from Mostafa Rassaian and Kyle Indermuehle has enabled focusing on two mainstream modeling approaches*
- *MAT54 in LS-DYNA is a progressive failure model*
- *VUMAT Fabric in ABAQUS Explicit is a damage mechanics model*
- *Modeling of the corrugated specimen has initiated*
- *Need to better understand the dependence of measured energy absorption on model parameters – both material related and damage related*
- *Generation of material properties and various coupons for the designated material system is nearing completion*

Conclusions of Year I

- *Experimentally, the research shows a need for a self-supporting geometry. Comparison across flat and corrugated specimen geometries has been performed*
- *Numerically, Progressive Failure models achieved the target crushing response, while Damage Mechanics models show more difficulty*
- *The material necessary to generate the properties for numerical modeling as well as to conclude the experimental study is being molded by TORAY Composites America.*



Future work in Year II

- *Experimentally, systematic comparison of crush response across 4 specimen geometries will be performed*
- *Numerically, the models using MAT54 and VUMAT Fabric will be updated to reflect final material properties, will be calibrated against the corrugated specimen, and will be used to predict the response of the other specimen geometries*

CMH-17 Handbook

- *CMH-17 can be an excellent forum for coordinating multi-organizational efforts aimed at standardizing composite analysis and testing*
- *Summarize and report recommended test practices*
- *Summarize and report simulation best practices*