

RESEARCH REPORT GUIDELINES

The State of Washington
Washington State Department of Transportation
Roger Millar, Secretary

Original publication: September 1994

Revised March 2020
by WSDOT Research & Library Services

Contents

Guidelines for WSDOT Research Reports.....	1
Final WSDOT Research Report Submittal Checklist.....	11, 12
Appendix A. Example Research and Interim Report	A.1-24

GUIDELINES FOR WSDOT RESEARCH REPORTS

Each research project requires a Research Report. Interim reports are sometimes specified in contracts of phased studies or studies that span several years. They document progress, conclusions, or recommendations at a given point in the study.

SUMMARY

- Purpose: To provide a 35- to 50-page document. With minor modifications, this report should also be suitable for publication in a journal.
- Distribution: Research reports, especially for State Planning Research (SPR) funded research, will be distributed to all required recipients as stipulated by FHWA, and to WSDOT, other state DOTs, universities, libraries and other interested researchers including subscribers to WSDOT's Transportation Research alerts. They will also be published online at WSDOT's Research Reports website (<http://www.wsdot.wa.gov/research/reports/default.htm>).
- Requirements: Pages 3 through 10
- Example: Appendix A.1 through A.24.

This format is intended to provide concise, abbreviated documentation of a project. The report should provide readers with a brief history of the problem and the ways in which others have addressed it, an overview of the research approach and procedures used, and a thorough understanding of the findings and their implications

If a project requires more detailed, technical documentation that exceeds the recommended page limit, please consult with the WSDOT Research Manager assigned to your contract for options.

Upon completion, reports should be submitted electronically to the Research Manager assigned to the contract, as Word documents. Please include at least one photo to use on the cover, in .jpg format. Researchers at the University of Washington and Washington State University should submit reports through their respective Washington State Transportation Center (TRAC) offices.

LENGTH AND FONT

Research reports should be no longer than 35 to 50 printed, double-spaced pages, including figures and tables. Margins should be 1 inch on top and bottom and 1.25 inches on the left and right. The preferred type face and font size for body text is 12 point Times Roman.

STYLE

To achieve uniformity and consistency, use *Webster's Third International Dictionary* or the latest edition for spelling, definitions and compounding. Published standards of learned societies are accepted in questions of usage of technical terms. Other matters of style and usage are based on widely accepted style manuals such as the *Chicago Manual of Style* or *The Gregg Reference Manual*.

PARTS OF THE RESEARCH REPORT

- Title page
- Technical Report Documentation Page (with Abstract), DOT Form F1700.7
- Disclaimer
- Table of Contents (including Figures and Tables)
- Body of Report
 - Executive Summary
 - Introduction or Background
 - Review of Previous Work
 - Research Approach/Procedures
 - Findings/Discussion
 - Conclusions
 - Recommendations/Application/Implementation
- Acknowledgments
- References
- Appendices

Title page

The title page should include the title of the report, name(s) of the principal investigator(s) and other authors, their research agency(ies), name and title of technical contact at WSDOT, type of report, title of project, name of sponsoring agency, and date of publication, using the format shown in the Appendix A example.

Form DOT F1700.7 (8-72), Technical Report Documentation Page

You can obtain this form from the American Association of State Highway and Transportation Officials (AASHTO) Standing Committee on Research (SCOR)/ Research Advisory Committee (RAC) website, from TRAC, or from the WSDOT

Research Office. The form requires an abstract, which should be self-contained and not require reference to the report to be understood. The abstract should not contain unfamiliar terms, acronyms, abbreviations, symbols, or equations. It should review the primary objectives and scope of the study; the techniques or approaches should be described only to the extent necessary for comprehension; and the findings and conclusions should be presented concisely. Key terms should reflect language used in the report; additional terms can be found in the Transportation Research Board (TRB) Transportation Research Thesaurus (<http://trt.trb.org/trt.asp?>).

Disclaimer

The disclaimer is to read:

"The contents of this report reflect the views of the author(s), who is (are) responsible for the facts and the accuracy of the data presented herein. The contents do not necessarily reflect the official views or policies of the Washington State Department of Transportation, Federal Highway Administration, or U.S. Department of Transportation [and/or another agency]. This report does not constitute a standard, specification or regulation."

Table of Contents

Include lists of Figures and Tables after main contents listing.

Body of Report

The body of the report should be organized in the following manner:

- Executive Summary
- Introduction or Background
- Review of Previous Work
- Research Approach/Procedures
- Findings/Discussion
- Conclusions
- Recommendations/Application/Implementation

Executive Summary. Write the executive summary with the busy transportation professional in mind. It should be no longer than 10 pages and should be comprehensible apart from the larger document. It should contain a readable yet condensed description, explained within the context of the project scope and objectives, of the research findings, conclusions, and recommendations that evolved from the project. Beyond these elements, it should contain only information that is essential to an understanding of the findings and how they relate to the solution of the operational problem. *Do not summarize the full report.*

Introduction or Background. Discuss the problem that led to the study, current

knowledge that can help in its solution, and the objectives and scope of the assigned research.

Review of Previous Work. Summarize or highlight the project's literature review, state-of-the-art survey, or the work that others have performed in relation to the problem at hand.

Research Approach/Procedures. Discuss the approach that was used in attempting to solve the problem. Include in the appendices forms that may have been used in soliciting information or details regarding test procedures or analyses.

Findings/Discussion. Present the research findings that evolved from the project. Include in the appendices summary data, principal mathematical formulas that were developed, or other technical details.

Conclusions. Conclusions are concerned with general principles suggested in the findings. They are extensions of the findings beyond conditions specific to the project.

Recommendations/Applications/Implementation. Recommendations should address specific actions that WSDOT should consider. Discuss the implications of the findings in relation to standards, specifications, policies, and procedures; what they add to an understanding of the problems; and what effects they have on economy, safety, amenities, and convenience. Assess their limitations. Items recommended for implementation should be identified and necessary implementation steps listed.

References

1. Arrange the reference list alphabetically by author (or publication information if no author); list only the references cited in the text.
2. Denote a reference at the appropriate place in the text (preferably after, rather than interrupting, a sentence) by the author's name and publication date in parentheses. Example: (Reed 1993)

To include a page number, follow the author and date with a comma and the page number. Example: (Reed 1993, 62)

3. Do not reference any material that would not be available to readers in printed form, such as unpublished material, personal communications, telephone conversations, etc. Instead, state these references in parentheses in the text with the term unpublished data.
4. Do not repeat a reference in the list and do not use *ibid.*, *op. cit.*, or *loc. cit.* If a reference is cited more than one time in the text, repeat the author/date citation.

5. Be sure that references are complete. If a reference has no date, include the information "undated."
6. Do not include sources not cited in the text. To include additional sources, create a separate bibliography.

Appendices

Appendices should contain (1) materials that are needed to support, explain, or substantiate the main body of the report or (2) discussions whose technical nature would make them inappropriate for or disruptive to the main body of the report. Each appendix should be designated by letter and title, and references to appendices should be made at appropriate places in the text. Numbering appendices by letter (e.g., A.1, A.2, etc.) makes report production easier.

Appendices may contain the following:

- state-of-the-art survey
- manuals and guidelines
- documentation and further elaboration of research findings
- forms
- mathematical analyses
- project statement and project working plan (including any approved revisions)

METRICATION

Current WSDOT rules do *not* require that authors use the International System (SI) units. SI units in parentheses are encouraged. WSDOT recommends the *American National Standard for Use of the International System of Units (SI): The Modern Metric System, Revision IEEE/ASTM SI 10-1997* and AASHTO's *Guide to Metric Conversion* for guidance in converting units from U.S. Customary to SI.

EQUATIONS

1. Use equation editors that are built into the most commonly used word processing applications. Do *not* paste equations in graphics in interchange format (GIF) or tagged image file format (TIFF); typically these cannot be revised and slow document production.
2. Distinguish carefully among the following:
 - all capital and lowercase letters
 - capital O, lowercase o and 0 (zero)

- lowercase l and number 1 (one)
 - letter X, Greek χ and the multiplication sign \times
 - prime ', apostrophe' and superscript ¹
 - English and Greek letters such as B and β , n and η , u and μ , p and ρ , and w and ω
3. Number all displayed equations with Arabic numerals in parentheses aligned flush right, e.g.:

$$(x + a)^n = \sum_{k=0}^n f(x)=a_0 + \sum_{n=1}^{\infty} \left(a_n \cos \frac{n\pi x}{L} + b_n \sin \frac{n\pi x}{L} \right) \binom{n}{k} x^k a^{n-k} \quad (\text{Equation 1})$$

FOOTNOTES

Avoid using footnotes to the text. Incorporate such notes within the text.

ABBREVIATIONS, ACRONYMS, AND SYMBOLS

Abbreviations, acronyms, and symbols must be fully defined the first time they are used in the paper; the definition should be given first, followed by the abbreviated term in parentheses.

TABLES

1. If tables are not presented on separate pages, leave at least 1 inch of white space between a table and the text.
2. Number the tables consecutively with Arabic numerals and give each table a title. In longer reports or those with many tables, you may number the tables by chapter (e.g., Table 1.1, Table 1.2, Table 2.1). The title should briefly identify the table; furnish background information, describe the results given in the table, or include information provided by column heads in the text, not in the table title.
3. Refer to each table at the appropriate place in the text.
4. Give each column in the table a heading and leave plenty of space around headings.
5. Denote footnotes in tables by superscript letters.
6. Indicate the meaning of a dash (—) when it is used in a table, i.e., whether it is used to indicate missing data, incomplete research, data not applicable or

unavailable, or a problem investigated but no results.

7. Check the accuracy of all totals.
8. The size of the type in tables should be no smaller than 10 point.
9. Each table must have a title.

FIGURES

1. Use professionally drawn graphics and charts that are clean, sharp and either black on white or contrasting colors. Shades of gray are acceptable. Mimeograph or xerox copies, pencil drawings, blueprints or ozalid prints, and negatives are **not** acceptable.
2. Insert jpgs of black and white or color photographs that are sharp, with good contrast, to show detail. Slides and negatives are **not** acceptable.
3. If figures are not presented on separate pages, leave at least 1 inch of white space between a figure and the text.
4. Number figures consecutively with Arabic numerals. In longer reports or those with many figures, you may number the figures by chapter (e.g., Figure 1.1, 1.2, 2.1, etc.).
5. Refer to each figure by number at the appropriate place in the text.
6. Do not use lettering of figures smaller than 10 point.
7. Figure sizes, line weights, and letter sizes should be uniform throughout the report.
8. Each figure must have a caption.

ADA/TITLE VI NOTICE

By law, all WSDOT public documents must include Americans with Disability Act and Title VI of the Civil Rights Act of 1964 notifications:

Title VI Notice to Public

It is the Washington State Department of Transportation's policy to assure that no person shall, on the grounds of race, color, national origin or sex, as provided by Title VI of the Civil Rights Act of 1964, be excluded from participation in, be denied the benefits of, or be otherwise discriminated against under any of its federally funded programs and

activities. Any person who believes his/her Title VI protection has been violated, may file a complaint with WSDOT's Office of Equal Opportunity. For additional information regarding Title VI complaint procedures and/or information regarding our non-discrimination obligations, please contact OEO's Title VI Coordinator at 360-705-7082.

Americans with Disabilities Act (ADA) Information

This material can be made available in an alternate format by emailing the Office of Equal Opportunity at wslotada@wsdot.wa.gov or by calling toll free, 855-362-4ADA (4232). Persons who are deaf or hard of hearing may make a request by calling the Washington State Relay at 711.

Referenced Websites and Additional Guidance

The websites and additional sources of information listed below were referenced in the guidelines and/or are included to provide supplementary guidance for report production:

American National Standard for the Use of the International System of Units (SI):
The Modern Metric System -- Revision IEEE/ASTM SI 10-1997

AASHTO SCOR/RAC website, *Report Guidelines and Requirements*:

<http://research.transportation.org/Pages/Report-Guidelines-and-Requirements.aspx> Technical Report Documentation Page, Form DOT F 1700.7 (8-72) template with instructions, example form and guidelines for filling out the form

The Chicago Manual of Style, 16th ed., 2010. Chicago: University of Chicago Press.

Sabin, William A. *The Gregg Reference Manual: a manual of style, grammar, usage, and formatting*, 11th ed., 2011. New York: McGraw-Hill.

SI Quick Reference Guide: International System of Units (SI): The Modern Metric System--ASTM R0017

Transportation Research Thesaurus, Transportation Research Board:
<http://trt.trb.org/trt.asp?>

WSDOT Research Reports website:
<http://www.wsdot.wa.gov/research/reports/default.htm>

WSDOT Research Report Submittal Checklist -- see next 2 pages

Final WSDOT Research Report Submittal Checklist

This checklist is designed as a helpful guide to researchers and WSDOT Research Managers to ensure that when final reports are submitted for web publication and distribution, they have undergone thorough review and are accurate, complete and ready for dissemination. NOTE: some of the items on the checklist only pertain to WSDOT Research Managers. Thank you.

Formatting

- Report is in Word format and in final form (i.e., “draft” or “interim” notations removed)
- Technical Report Documentation Page (Form DOT F1700.7 (8-72)) is included and filled in as completely as possible
*See AASHTO RAC/SCOR website for Template with Instructions, Example and Guidelines:
<http://research.transportation.org/Pages/report-guidelines-and-requirements.aspx>*
- WA-RD report number has been assigned and is noted in Box 1 of Technical Report Documentation Page (TRDP)
Contact your Research Manager if you need a WA-RD report #.
- Titles and dates match on title page of report and TRDP
- Disclaimer page is included after TRDP
- Table of Contents (TOC) pages as listed match up to actual paging
- Appendices are included in TOC [Y/N], as are references [Y/N]
- Tables and figures are listed within TOC [Y/N], or separately following the TOC [Y/N]
- All pages, including appendices, are included in submittal

Content

- Formulas and calculations have all been double-checked
- Imbedded links have been double-checked and any broken ones corrected or deleted
- Content has been checked and approved by project team/technical monitor/subject matter experts
- Final Word version filed on G drive: 30 Research>80 Reports and Final Products>10 WA-RD Reports>Reports

Report Publication and Distribution

- Photo(s) for cover, in .jpg format, are also submitted with report for publication
- Report is ready for publication on the Internet and distribution to WSDOT research listserv subscribers as indicated on the Research Topics list below

Project Close-Out

- RPMD entry completed and closed

Research Topics for WSDOT Research Report Distribution via GovDelivery

Please indicate appropriate topic area(s) for distribution of attached report:

- Administration and Management
- Bicycle and Pedestrian
- Bridges and Structures
- Climate Change
- Congestion and Traffic Management
- Construction and Materials
- Data and Information Technology
- Design
- Environment and Energy
- Ferries
- Finance and Economics
- Freight
- Intelligent Transportation Systems
- Knowledge Management
- Maintenance
- Planning
- Public Transportation
- Rail
- Safety
- Security

March 2016

APPENDIX A

EXAMPLE RESEARCH REPORT

January 2017

**Research Report
Agreement T4118, Task 92
WSF Bearings Tests**

**FATIGUE AND STRENGTH TESTS
OF HEAT-STRAIGHTENED FERRY LOADING
BRIDGE HANGER BARS**

by

Jeffrey W. Berman
Associate Professor

Vince Chaijaroen
Structures Lab Manager

Department of Civil and Environmental Engineering
University of Washington, Box 352700
Seattle, Washington 98195

Washington State Transportation Center (TRAC)
University of Washington, Box 359446
University Tower
4333 Brooklyn Ave NE
Seattle, Washington 98195-9446

Washington State Department of Transportation
Technical Monitor
Jeri Bernstein
Bridge Engineer, Washington State Ferries

Prepared for

The State of Washington
Department of Transportation
Roger Millar, Secretary

June 2013

TECHNICAL REPORT DOCUMENTATION PAGE

1. REPORT NO. WA-RD 813.1		2. GOVERNMENT ACCESSION NO.		3. RECIPIENT'S CATALOG NO.	
4. TITLE AND SUBTITLE FATIGUE AND STRENGTH TESTS OF HEAT-STRAIGHTENED FERRY LOADING BRIDGE HANGER BARS				5. REPORT DATE June 2013	
				6. PERFORMING ORGANIZATION CODE	
7. AUTHOR(S) Jeffrey W. Berman, Vince Chaijaroen				8. PERFORMING ORGANIZATION REPORT NO.	
9. PERFORMING ORGANIZATION NAME AND ADDRESS Washington State Transportation Center (TRAC) University of Washington, Box 354802 University District Building; 1107 NE 45th Street, Suite 535 Seattle, Washington 98105-4631				10. WORK UNIT NO.	
				11. CONTRACT OR GRANT NO. Agreement T4118 Task 92	
12. SPONSORING AGENCY NAME AND ADDRESS Research Office Washington State Department of Transportation Transportation Building, MS 47372 Olympia, Washington 98504-7372 Project Manager: Rhonda Brooks, 360-705-7945				13. TYPE OF REPORT AND PERIOD COVERED Final Research Report	
				14. SPONSORING AGENCY CODE	
15. SUPPLEMENTARY NOTES This study was conducted in cooperation with the U.S. Department of Transportation, Federal Highway Administration.					
16. ABSTRACT: <p>Tests were conducted on heat-straightened and/or bent live load hanger bars used in loading bridges in the Washington State Ferry (WSF) system. Both fatigue and ultimate strength tests were conducted. The study found that when heat-straightened three times, the hanger bars have a fatigue life that exceeds their design life. The data indicated that additional heat-straightening may be possible without concern for reducing the fatigue life. The yield strength of the hanger bars was found to be unaffected by either heat-straightening or by initial bending deformations. In both cases the hanger bar yield strength exceeded nominal values. The ultimate strength was somewhat reduced by the presence of initial bending deformation.</p>					
17. KEY WORDS Live load hanger bars, ferry bridges, fatigue, heat-straightening			18. DISTRIBUTION STATEMENT No restrictions. This document is available to the public through the National Technical Information Service, Springfield, VA 22616		
19. SECURITY CLASSIF. (of this report) None		20. SECURITY CLASSIF. (of this page) None		21. NO. OF PAGES	22. PRICE

Disclaimer

The contents of this report reflect the views of the authors, who are responsible for the facts and the accuracy of the data presented herein. The contents do not necessarily reflect the official views or policies of the Washington State Department of Transportation or Federal Highway Administration. This report does not constitute a standard, specification, or regulation.

Example

CONTENTS

Executive Summary	ix
Introduction, Motivation and Objectives	1
Fatigue Testing Set-Up and Results	4
Ultimate Strength Testing Set-Up and Results	6
Conclusions.....	12
Laboratory Disclaimer Statement	13
Appendix.....	A.1

FIGURES

Figure 1. Loading Bridge Cross-Section with Hanger Bars Labeled..... 1

Figure 2 Loading Bridge Elevation with Hangar Bar Labeled 2

Figure 3 Hanger Bar Detail 3

Figure 4 (a) Fatigue Test Set-Up and (b) Fatigue Specimen 4

Figure 5 Ultimate Strength Test Set-Up (a) Nominal 10-ft Specimen and (b) 40-in. Specimen..... 6

Figure 6 (a) Example of Typical Slotted Hole Yielding and Deformation and (b) Example of Typical net Section Fracture 7

Figure 7 Load vs. Time Curves for Ultimate Strength Tests 9

TABLES

Table 1 Details and Yield and Ultimate Strengths of Tested Hanger Bars 10

EXECUTIVE SUMMARY

Objectives

The objective of this study was to determine whether heat-straightened and/or bent ferry loading bridge hanger bars have adequate fatigue life and ultimate strength.

Background

The bridges used to load vehicles onto Washington State ferries are supported on one end by hanger bars. These bars carry bridge loads in tension but can buckle in compression as the ferry rises with rising tides while at the dock. Washington State Ferries (WSF) engineers heat-straighten the buckled bars and return them to service. However, it is unclear whether the bars can be heat-straightened three times and safely reused. It is also unclear to WSF engineers what the ultimate tensile capacity of the plastically buckled bars is.

Research Activities

Two sets of tests were conducted on heat-straightened hanger bars. First, bars that had been heat-straightened three times were tested under fatigue loading with the amplitude of the varying loading near the design load for the bars, determined by the live truck loads on the bridge. Second, several hanger bars, heat-straightened two or three times or cold bent to 5 degrees, were tested in tension to failure to determine their ultimate strength.

Conclusions

Fatigue tests demonstrated that hanger bars heat-straightened three times have a fatigue life of at least 3 million cycles at a load range of 50 kips (10 kips tension to 60 kips tension). The ultimate strength tests demonstrated that the bars were able to reach the yield capacity of the net section regardless of the heat straightening or initial out-of-straightness. Ultimate hanger bar strength was not affected by heat-straightening, but initial out-straightness did reduce the ultimate capacity slightly. Results from all tests indicated that, for loads within the range used for testing, bars may be safely heat-straightened at least three times—and likely more—and returned to service.

INTRODUCTION, MOTIVATION AND OBJECTIVES

The bridges used to load vehicles onto Washington State ferries are supported on one end by hanger bars. Figures 1, 2, and 3 show a typical loading bridge and hanger bar. These bars carry bridge loads in tension, but they can buckle in compression as the ferry rises with rising tides while at the dock or when workers adjust the bridge without removing the pins. Washington State Ferries (WSF) engineers then heat-straighten the bars and return them to service. However, it is unclear whether the bars can be heat-straightened three times and safely reused.

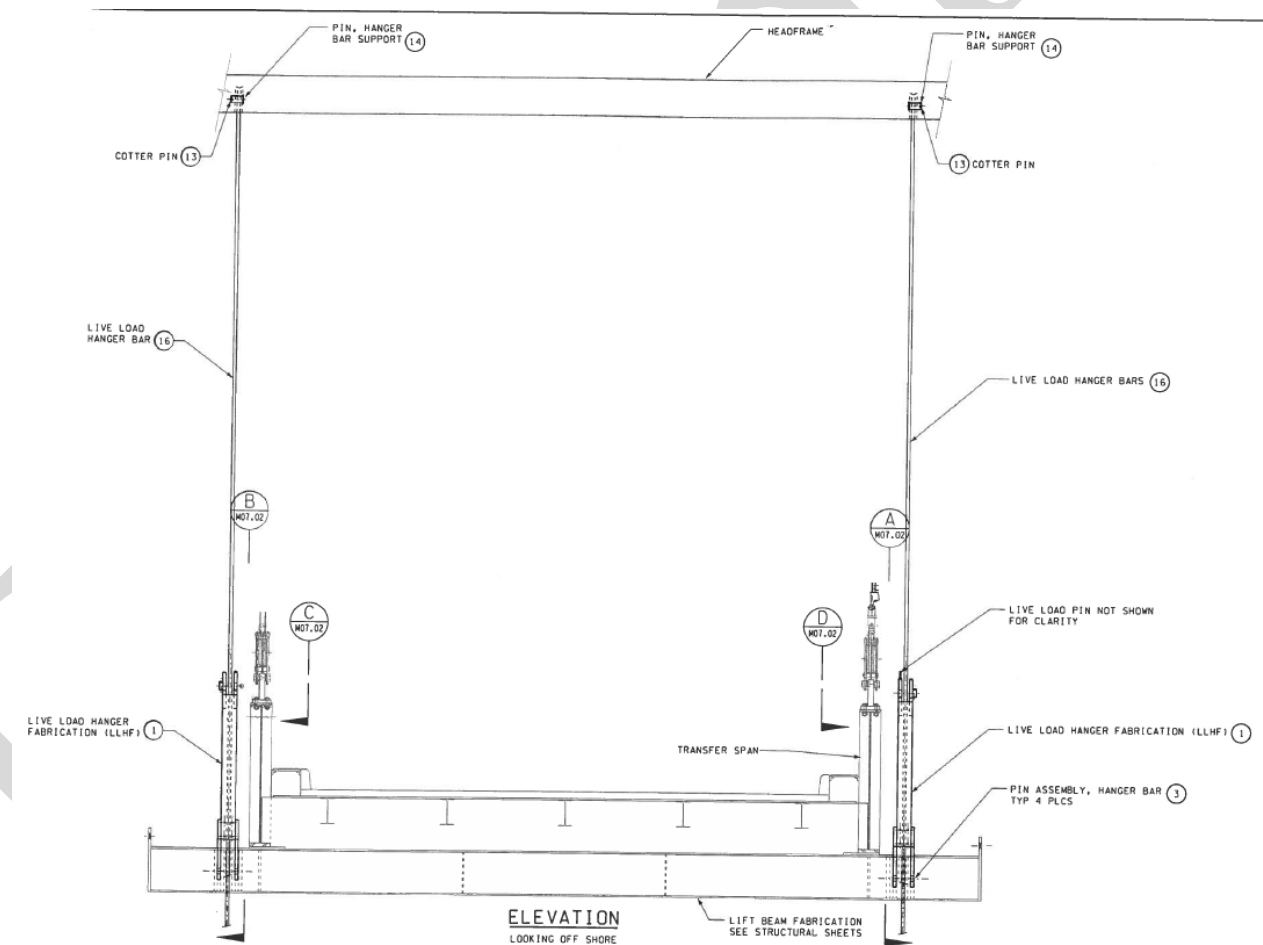

Figure 1. Loading Bridge Cross-Section with Hanger Bars Labeled.

The objective of this research was to determine whether heat-straightened ferry loading bridge hanger bars have adequate fatigue life and ultimate strength. To achieve this objective, the researchers carried out fatigue and ultimate strength tests in the University of Washington (UW) Structural Research Laboratory (SRL).

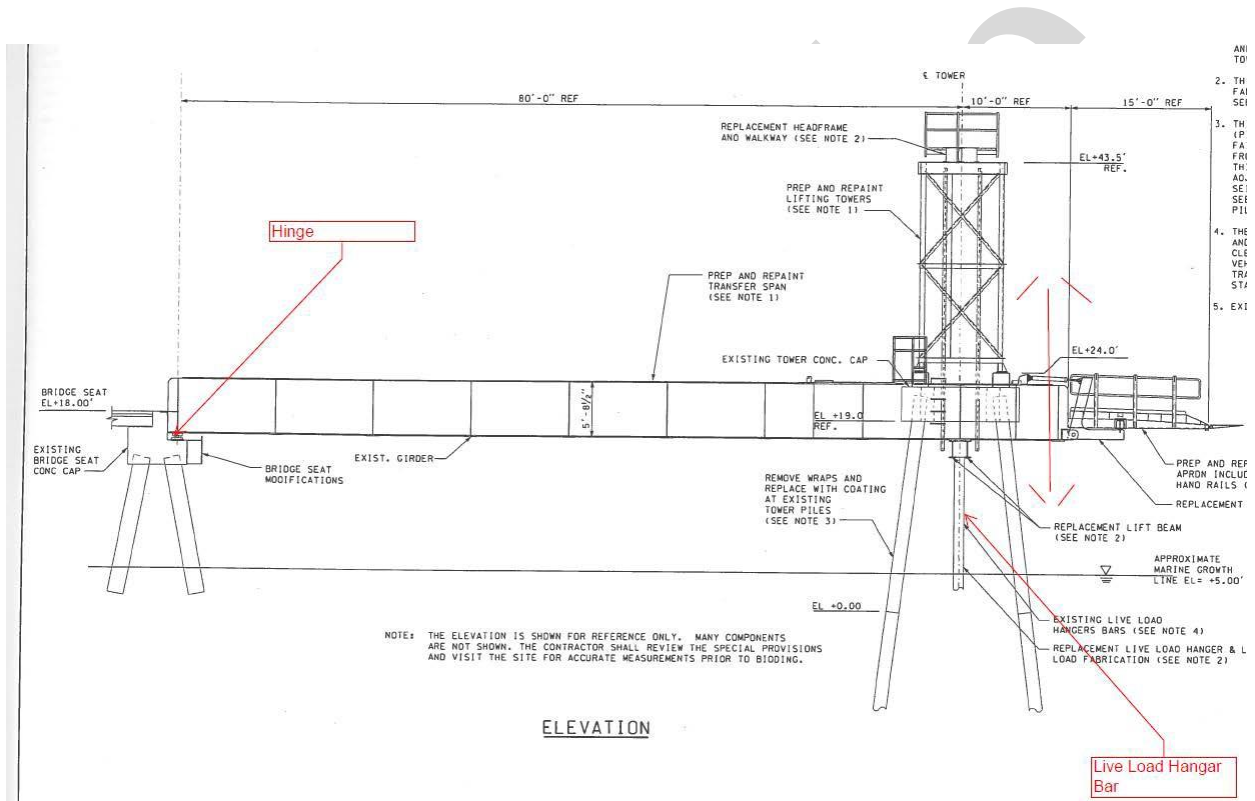

Figure 2. Loading Bridge Elevation with Hanger Bar Labeled.

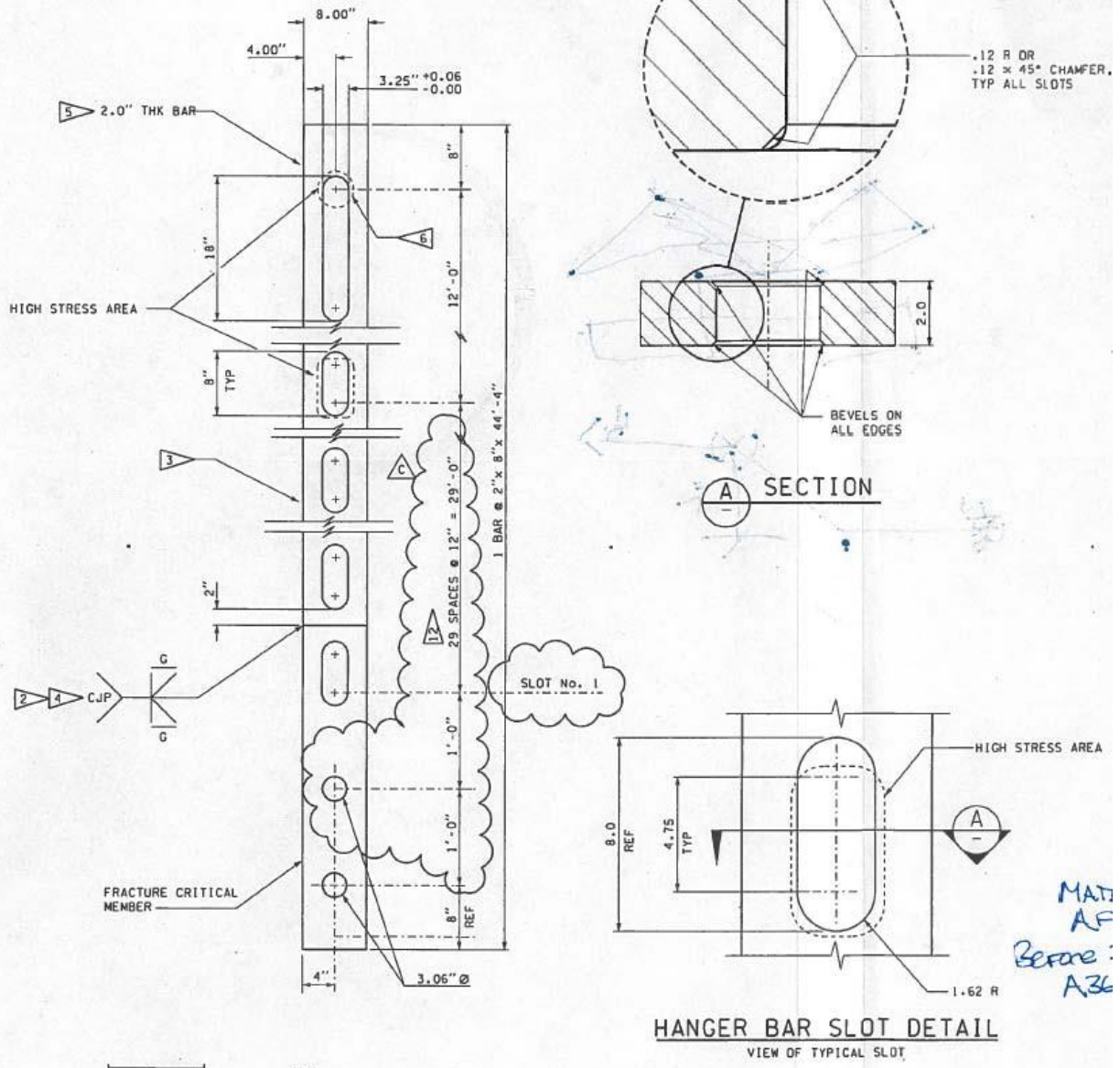

Figure 3. Hanger Bar Detail

FATIGUE TESTING SETUP AND RESULTS

Test Set-Up

Two hanger bar specimens were tested under fatigue loading in a 110-kip fatigue test frame in the SRL. The test set-up is shown in Figure 4a. The specimens were 40 in. long and had three of the oval shaped holes shown in Figure 3, with 4 in. of overhang on each end. A typical specimen is shown in Figure 4b. Each specimen had been heat-straightened three times, and they were named 3A and 3B. The specimens were connected to the test frames by using a series of plates and pins. The pins that were used in bearing against the hanger bars were identical to those used in the ferry loading bridges to ensure that the stress distribution in the tests closely matched that expected in the field.

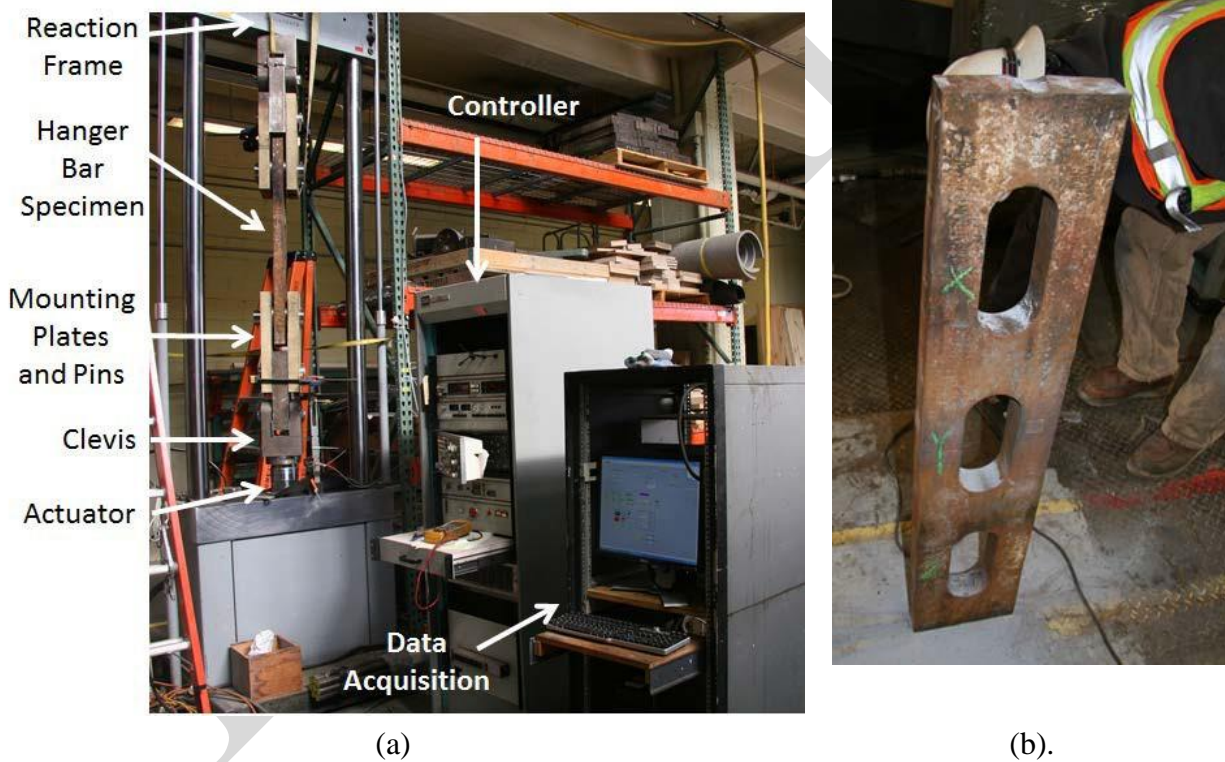

Figure 4. (a) Fatigue Test Setup (b) Fatigue Specimen

Mayes Testing Inc. conducted magnetic particle testing on both the fatigue specimens before and after testing to look for cracks. Some surface cracks were noted before testing but were likely the result of corrosion and did not grow during the tests. The inspection reports from Mayes Testing Inc. are included in the Appendix.

Both specimens were subjected to sinusoidal cyclic fatigue loading with peaks at 60 kips and 10 kips of tension at a rate of 3 Hz. The loading was conducted around the clock, and emergency switches were utilized to sense a failure and stop the hydraulic system. This loading protocol was agreed to by the SRL staff and the WSF engineers. They determined that the specimens should be subjected to 3 million cycles of loading, at which point the tests would be stopped if no failure occurred.

Experimental Results

Both specimens were loaded to 3 million cycles without failure. Post-test magnetic particle inspections conducted by Mayes Testing Inc. showed no signs of cracking at the hanger bar net section or in the regions of heat-straightening. Both specimens were then reused in the ultimate strength tests described below. Although twice heat-straightened specimens were also prepared, they were not tested in fatigue because the specimens that had been straightened three times performed well. Instead, they were tested for ultimate strength as described below. The design life for these bars is 10 years, and according to WSF engineers, the design life results in a loading of 1.3 million cycles at the tested stress range. Therefore, the experimental results indicated that the bars heat-straightened three times have ample fatigue life for their intended design life.

ULTIMATE STRENGTH TESTING SET-UP AND RESULTS

Test Set-up

Ultimate strength tests were conducted at the top of the SRL's 2.4-million-pound capacity Universal Testing Machine (UTM). Two lengths of specimens were tested: (1) nominally 10-ft-long bars, one that had been heat-straightened multiple times and two that were installed bent to simulate their condition after buckling, and (2) 40-in.-long bars that were used (or designed to be used) in the fatigue test set-up. Figure 5 shows the two types of specimens installed in the UTM. The material for all bars was either A36 or an unknown older steel.



(a)



(b).

Figure 5. Ultimate Strength Test Setup (a) Nominal 10 ft Specimen (b) 40 in. Specimen

The set-up utilized pin connections at each end of the hanger bars, and the pins used were identical to those used in the field. Loading was applied slowly to each specimen and continued until failure. Only the load was recorded during the tests. However, the tests were conducted under displacement control, i.e., the displacement of the UTM crosshead was used to control loading during the test. This crosshead displacement was applied at a uniform, slow rate. Thus, plotting the force applied versus time would indicate when the specimens began to yield, since there is a linear relationship between time and displacement.

Experimental Results

Each specimen exhibited reasonable ductility before fracturing either at a net section area adjacent to a slotted hole within the length of the specimen or at the net section where the pins connected to the specimens. After the tests, signs of yielding at all net section areas adjacent to the slotted holes were visible. An example is shown in Figure 6a. An example of the typical net section fracture that occurred after significant inelastic deformation is shown in Figure 6b.

Table 1 lists the details of each specimen. Specimens Ult1 and Ult2 were 10 ft long and were tested after being bent (Figure 5a). Specimen Ult3 had been heat-straightened three times. Specimens F3A and F3B were 40 in. long and had been subjected to 3 million cycles of fatigue loading as described above. Specimens F2A and F2B were 40 in. long and had been heat-straightened twice. As noted above, all specimens exhibited ductile behavior, and the two bent specimens did not fracture at the bend but rather at a different net section (at the pin connection or one slotted hole away from the pin connection).

Figure 7 shows the force versus time curves for each tested specimen, where the names correspond to the information in Table 1. As noted above, a constant rate of crosshead displacement was used to control the test so that the load versus time curves would be similar to load deformation curves. Figure 7 shows that each specimen had a clear yield point at which the slope of the curve changed. This was followed by ductile inelastic deformation and eventual fracture at a net section adjacent to a slotted hole. Note that the two long bent specimens showed a smaller initial stiffness as the bend in the bar was straightened. Also note that those two

Table 1. Details and Yield and Ultimate Strengths of Tested Hanger Bars

Specimen ID	Specimen Length	Specimen Details	Yield Strength ¹ (kips)	Ultimate Strength ² (kips)
F2A	40 in.	Heat-straightened two times, loaded only for ultimate strength, A36 steel	408	651
F2B	40 in.	Heat-straightened two times, loaded only for ultimate strength, A36 steel	405	638
F3A	40 in.	Heat-straightened three times, loaded in fatigue before ultimate strength, A36 steel	402	661
F3A	40 in.	Heat-straightened three times, loaded in fatigue before ultimate strength, A36 steel	404	668
Ult1	10 ft.	Bent bar at approximately 10°, loaded only for ultimate strength, A36 steel	407	539
Ult2	10 ft.	Bent bar at approximately 10°, loaded only for ultimate strength, A36 steel	402	570
Ult3	10 ft.	Heat-straightened, loaded only for ultimate strength, unknown steel	430	698
Nominal	-	36 ksi yield stress, 58 ksi ultimate stress	342	551

¹Yield strength estimated as point of significant change in slope in Figure 7 plots.

²Maximum force obtained during test.

specimens had slightly lower ultimate strengths than the other specimens, although the yield strength was similar.

By using the curves of Figure 7, the yield and ultimate strengths of each specimen were determined, and the results are given in Table 1. The table also shows the nominal yield and ultimate strengths, assuming a yield stress of 36 ksi and an ultimate stress of 58 ksi each, times the net area at a long slotted hole of 9.5 in². A comparison of the nominal and experimentally obtained values indicated that the inelastic buckling deformation, heat-straightening (up to three times), and fatigue loading generally did not affect the yield strengths of the bars. The data in Table 1 do indicate that the bars tested in the bent configuration had somewhat lower ultimate

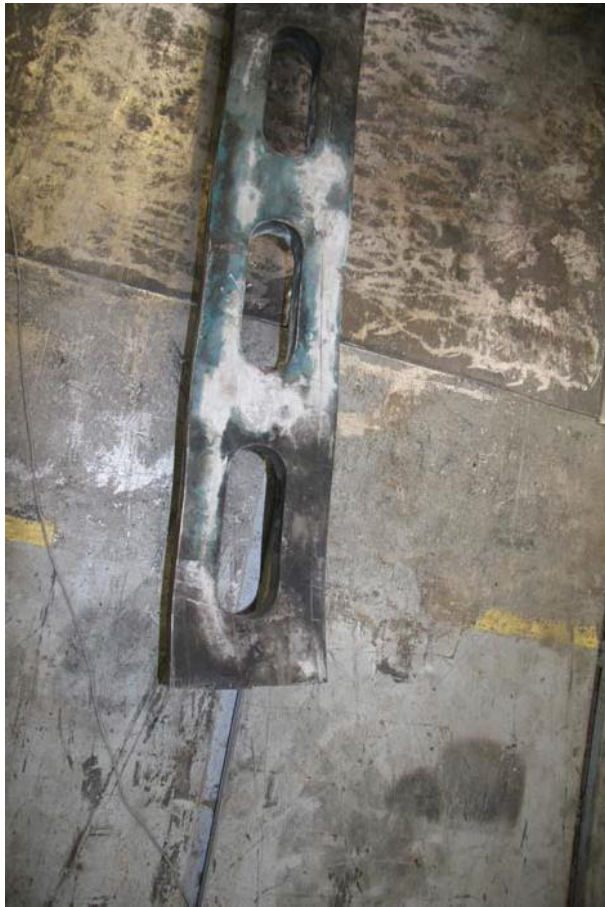

(a)



(b)

Figure 6. (a) Example of typical slotted hole yielding and deformation. (b) Example of typical net section fracture.

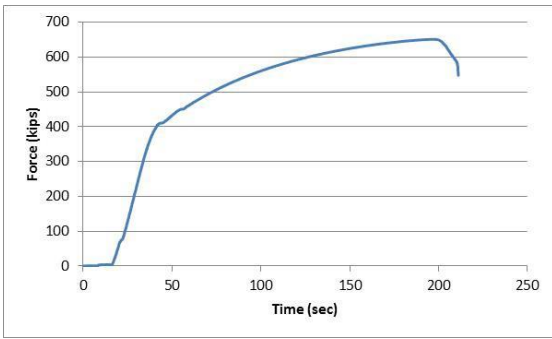

(a) Specimen F2A

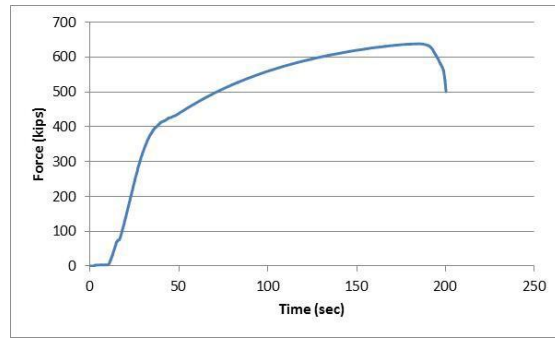

(b) Specimen F2B

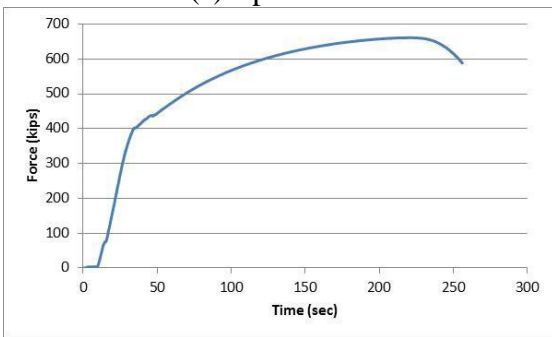

(c) Specimen F3A

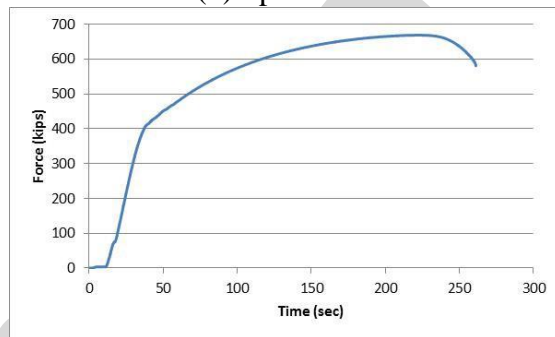

(d) Specimen F3B

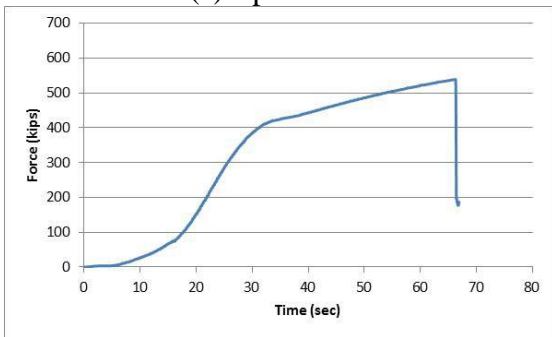

(e) Specimen Ult1

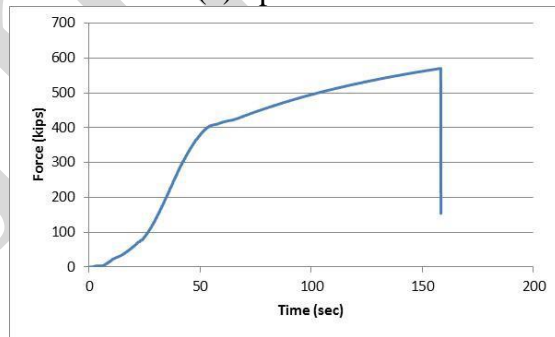

(f) Specimen Ult2

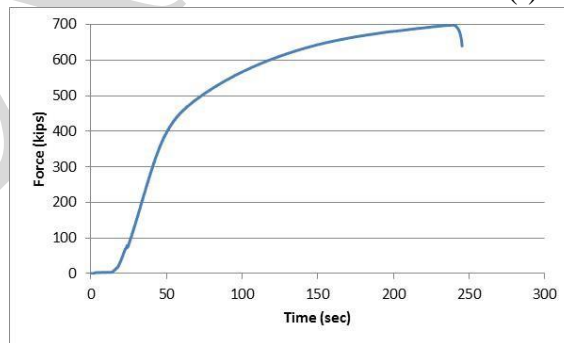

(g) Specimen Ult3

Figure 7. Load vs. Time Curves for Ultimate Strength Tests

strengths, producing effective ultimate stresses of 56.7 for Specimen Ult1 and 60 ksi for Specimen Ult2. The former was slightly lower than the minimum ultimate stress for A36 of 58 ksi. It is unclear why these specimens exhibited a lower ultimate strength, especially given that the fractures occurred far from the bends. Heat-straightening and fatigue loading were not found to affect the ultimate strength.

Example

CONCLUSIONS

The testing program demonstrated that hanger bars heat-straightened up to three times are able to

- resist 3 million cycles of fatigue loading with a range of 50 kips
- develop good ductility
- achieve yield strengths consistent with the yield stress of the original material, and
- achieve ultimate strengths consistent with the tensile stress of the original material.

Hanger bars with large bends from inelastic buckling are also able to achieve yield strengths consistent with the yield stress of the material, but they were observed in one case to have an ultimate strength slightly lower than what would be expected by developing the tensile stress of the material over the net section area.

EXAMPLE

LABORATORY DISCLAIMER STATEMENT:

The Structural Research Laboratory provides commercial testing services. These services are limited to testing and data collection. The results are valid at the time the test occurs on the specific specimens tested. The engineering response of similar items is not within the scope of the testing agreement. The SRL staff, the Department of Civil and Environmental Engineering, the College of Engineering, and the University of Washington disclaim any and all liability for any personal or property damage or loss as a result of use of the test results.

Example

APPENDIX

Below are inspection reports from Mayes Testing Engineers, Inc. They performed magnetic particle testing on the hanger bars before fatigue loading (inspection on April 2, 2013) to check for initial cracks and following fatigue loading (inspection on May 17, 2013) for Specimen F3A and F3B (denoted 3A and 3B in the inspections reports). As shown, no indications of significance were found. Small indications parallel to the direction of the applied load were found, but they were not due to the fatigue loading applied but instead may have been related to corrosion or material imperfections.

EXAMPLE

MAYES TESTING ENGINEERS, INC.

Project No. L13023
Project WSDOT Live Load Hangar Bar
Address More Hall, University of Washington, Seattle, WA
Permit No. N/A
Bldg Dept. N/A

Owner University of Washington

Record No. 001
Date 4/9/2013
Weather (indoors)
Inspection Welding
Sample(s) N/A

Seattle Office
20225 Cedar Valley Road
Suite 110
Lynnwood, WA 98036
ph 425.742.9360
fax 425.745.1737

Tacoma Office
10029 S. Tacoma Way
Suite E-2
Tacoma, WA 98499
ph 253.584.3720
fax 253.584.3707

Portland Office
7911 NE 33rd Drive
Suite 190
Portland, OR 97211
ph 503.281.7515
fax 503.281.7579

Performed magnetic particle examination of four load bar plates, 2A, 2B, 3A, and 3B. This inspection was performed to determine if there were any flaws prior to fatigue testing. Noted flaw in bottom of plate 3A at X end. Notified Jeff Berman and Vince with UW.



Fig. 1. Crack noted in bottom of 3A plate at X end

To the best of our knowledge, all items inspected today are in conformance with approved plans and specifications.

Inspector: Skip Szurek

Reviewed By:

A handwritten signature in blue ink, appearing to read 'Michael S. Dolder'.

Michael S. Dolder, P.E.
Vice President

MAYES TESTING ENGINEERS, INC

Nondestructive Examination Report

20225 Cedar Valley Road, Suite 110 Ph 425.742.9360
 Lynnwood, WA 98036 Fax 425.745.1737
 10029 S. Tacoma Way, Suite E-2 Ph 253.584.3720
 Tacoma, WA 98499 Fax 253.584.3707
 7911 NE 33rd Drive, Suite 190 Ph 503.281.7515
 Portland, OR 97211 Fax 503.281.7579

Project No.: L13023 Date: 4/9/13

Project: WSDOT Live Load Hangar Bar

Type of Inspection: MT PT

NDE Procedure: MTE-AWS Revision No.: 0 Acceptance Standard: AWS D1.1

Material Type: Carbon Steel Surface Condition: As Welded Machined Ground

Material Temp: 50's Heat Treatment: Before After

Magnetic Particle

Equip. Manufacturer: Parker Insp. Method: Dry Wet Visible Fluorescent

Model: B300 Current: AC DC Amperage: 6A

Serial No.: 16766 Cal Date: 1/13 Prod Spacing: 4" Head Shot Coil

Dye Penetrant

Penetrant Manufacturer: _____ Test Method: Solvent Removable Visible

Dwell Time: _____ Development Time: _____ Water Washable Fluorescent

Weld or Part No.	Location	Accept	Reject	Remarks
2A	four sides of plate	X		informational inspection
2B	four sides of plate	X		informational inspection
3A	top and both sides	X		informational inspection
	bottom		X	5" longitudinal crack at X end
3B	four sides of plate	X		informational inspection

No. of Items:

Type of Work: New Repair Rework Tested: 4 Accepted: 3 Rejected: 1

Inspector: Skip Szurek Level: II Accepted by: Skip Szurek

MTE 1520-2C, Rev 0, 7/2/07

Seattle Office
20225 Cedar Valley Road
Suite 110
Lynnwood, WA 98036
ph 425.742.9360
fax 425.745.1737

Tacoma Office
10029 S. Tacoma Way
Suite E-2
Tacoma, WA 98499
ph 253.584.3720
fax 253.584.3707

Portland Office
7911 NE 33rd Drive
Suite 190
Portland, OR 97211
ph 503.281.7515
fax 503.281.7579

Project No. L13023
Project WSDOT Live Load Hangar Bar
Address More Hall, University of Washington, Seattle, WA
Permit No. N/A
Bldg Dept. N/A

Owner University of Washington

Record No. 002
Date 5/17/2013
Weather (indoors)
Inspection Welding
Sample(s) N/A

Performed magnetic particle examination of two samples of hanger bar, labeled 3A and 3B. This examination was done after fatigue testing. One longitudinal indication was noted on bottom side of plate 3B between holes labeled X and Y. No other indications not previously noted were detected. Refer to attached Nondestructive Examination Report for additional details.

To the best of our knowledge, all items inspected today are in conformance with approved plans and specifications.

Inspector: Skip Szurek

Reviewed By:



Michael S. Dolder, P.E.
Vice President

EXAMPLE

